

BA350–LA Modular Storage Shelf

User's Guide

Order Number: EK–350LA–UG–001

This manual describes the BA350–LA storage shelf and the rules for configuring the shelf to include power, system building blocks (SBBs), device addressing, and SCSI buses. Procedures for determining shelf status and replacing blowers are also included.

**Digital Equipment Corporation
Maynard, Massachusetts**

First Edition: October 1992

The information in this document is subject to change without notice and should not be construed as a commitment by Digital Equipment Corporation. Digital Equipment Corporation assumes no responsibility for any errors that may appear in this document.

The software described in this document is furnished under a license and may be used or copied only in accordance with the terms of such license.

No responsibility is assumed for the use or reliability of software on equipment that is not supplied by Digital Equipment Corporation or its affiliated companies.

Restricted Rights: Use, duplication, or disclosure by the U.S. Government is subject to restrictions as set forth in subparagraph (c) (1) (ii) of the Rights in Technical Data and Computer Software clause at DFARS 252.227-7013.

Copyright © Digital Equipment Corporation 1992

Printed in U.S.A.
All Rights Reserved.

The postpaid READER'S COMMENTS card requests the user's critical evaluation to assist in preparing future documentation.

FCC NOTICE: The equipment described in this manual generates, uses, and may emit radio frequency energy. The equipment has been type tested and found to comply with the limits for a Class A computing device pursuant to Subpart G of Part 15 of FCC Rules, which are designed to provide reasonable protection against such radio frequency interference when operated in a commercial environment. Operation of this equipment in a residential area may cause interference, in which case the user at his own expense may be required to take measures to correct the interference.

AXP, DEC, DEC 10000, MicroVAX, RZ, VAXserver, and the DIGITAL logo are trademarks of Digital Equipment Corporation.

This document was prepared using VAX DOCUMENT, Version 2.0.

Contents

Preface	v
1 Introducing the BA350–LA Shelf	
1.1 BA350–LA Modular Storage Shelf Description	1–1
1.2 Shelf Status	1–3
1.2.1 Power Supply LEDs	1–3
1.3 Replacing SBBs	1–4
2 Configuring the BA350–LA Shelf	
2.1 Power Configuration Rules	2–1
2.2 SBB Configuration Rules	2–1
2.3 SBB Device Addressing Rules	2–2
3 BA350–LA Shelf SCSI Buses	
3.1 SCSI Bus Configuration Rules	3–1
3.1.1 Configuring a BA350–LA Shelf for a Single SCSI Bus	3–2
3.1.2 Configuring a BA350–LA Shelf for Two SCSI Buses	3–3
3.1.3 Configuring Multiple BA350–LA Shelves for a Single SCSI Bus	3–4
Index	
Figures	
1–1 BA350–LA Modular Storage Shelf — Front View	1–2
1–2 Power Supply LEDs	1–3
1–3 Removing an SBB from the Shelf	1–5
2–1 SBB Device Address Switch	2–3
3–1 BA350–LA SCSI Buses	3–1
3–2 Single BA350–LA Shelf for One SCSI Bus	3–2
3–3 Single BA350–LA Shelf for Two SCSI Buses	3–3
3–4 Single SCSI Bus on Two BA350–LA Shelves	3–4

Tables

1-1	BA350 DECstor/me Products	1-2
2-1	DECstor/me SBB Address Switch Settings	2-3

Preface

The *BA350-LA Modular Storage Shelf User's Guide* describes how to configure this BA350-LA shelf, and install and replace DECstor/me components.

Note

Shelf installation procedures are cabinet specific and are not included in this manual.

Intended Audience

This manual is intended for use by Digital customers and Digital Services engineers responsible for installing and maintaining BA350 DECstor/me modular storage shelf subsystems.

Structure

This manual is organized as follows:

- | | |
|-----------|---|
| Chapter 1 | Provides a description of the BA350-LA storage shelf including components, status signals, and replacement procedures. |
| Chapter 2 | Provides shelf-specific configuration rules for power, storage system building blocks (SBBs), shelves, and device addressing. |
| Chapter 3 | Provides a detailed description of shelf-specific SCSI buses including terminators, jumpers, and devices by bus and location. |

Related Documents

The following table lists documents (alphabetically by title) that contain information related to this product:

Document Title	Order Number
<i>BA350 Modular Storage Shelf Subsystem Configuration Guide</i>	EK-BA350-CG
<i>BA350 Modular Storage Shelf Subsystem User's Guide</i>	EK-BA350-UG
<i>BA35X-VA Vertical Mounting Kit User's Guide</i>	EK-350SV-UG
<i>BA350-EA Modular Storage Shelf User's Guide</i>	EK-350EA-UG
<i>BA350-SA Modular Storage Shelf User's Guide</i>	EK-350SA-UG
<i>BA655 SCSI Disk and Tape PIU Installation Guide</i>	EK-BA655-IN
<i>Installation Notice—RZ73 Bus Termination and Jumper Installation Guide</i>	EK-RZ73X-IS
<i>MicroVAX/VAXserver 3100 and DECsystem 5100 RZ25 Installation Guide Addendum</i>	EK-RZ2MV-AD
<i>RZ Series Disk Drive Reference Manual</i>	EK-RZXXD-RM
<i>RZ22, RZ23, RZ24 Disk Drive Subsystem Service Manual</i>	EK-RZ234-SV
<i>RZ24 Hard Disk Drive Installation Guide</i>	EK-RZ24I-IS
<i>RZ25-S Mounting Bolt/Bracket Installation Instructions</i>	EK-RZ25S-IN
<i>RZ2x Hard Disk Drive Upgrade Installation Instructions</i>	EK-RZ2XH-UG
<i>RZ2x Series Drive Bracket Installation Sheet</i>	EK-RZ2XD-UG
<i>TLZ06 Cassette Tape Drive Installation Guide</i>	EK-STEXP-AD
<i>TLZ06 Cassette Tape Drive Owner's Manual</i>	EK-TLZ06-OM

Documentation Conventions

The following conventions are used in this manual:

- boldface type** Boldface type indicates the first instance of terms being defined in text, in the glossary, or both.
- italic type* Italic type indicates emphasis and complete manual titles. In the glossary, italic type is also used to indicate cross-references.

Introducing the BA350–LA Shelf

This chapter describes the BA350–LA modular storage shelf including system building blocks (SBBs)¹, shelf status, and the procedure for replacing blowers.

Note

The procedures for installing this shelf, routing cables, and connecting cables are unique to the DEC 10000 AXP and DEC 7000 AXP systems. For a description of these procedures, see the *BA655 SCSI Disk and Tape PIU Installation Guide*.

1.1 BA350–LA Modular Storage Shelf Description

The BA350–LA shelf shown in Figure 1–1 is a DECstor/me modular storage array shelf for use in DEC 10000 AXP systems. The BA350–LA shelf cannot be used in any other DECstor/me configuration. The major differences between the BA350–LA shelf and other DECstor/me shelves are as follows:

- The BA350–LA shelf shown does not have any blowers and requires the DEC 10000 AXP system cabinet to furnish the cooling air.
- Only the BA35X–HB universal dc input power supply can be used in the BA350–LA shelf.
- The SHELF_OK status signal is not used with the BA350–LA shelf.

WARNING

Service procedures described in this manual that involve access to the rear of the shelf must be performed only by qualified service personnel.

¹ SBBs are devices mounted in either a 3½-inch or 5¼-inch modular carrier, including disk drives, tape drives, CDROMs, static storage devices, power supplies, adapters, CPUs, and so on.

Introducing the BA350–LA Shelf

1.1 BA350–LA Modular Storage Shelf Description

As shown in Figure 1–1, this shelf has a SCSI cable slot and eight SBB slots.

Figure 1–1 BA350–LA Modular Storage Shelf — Front View

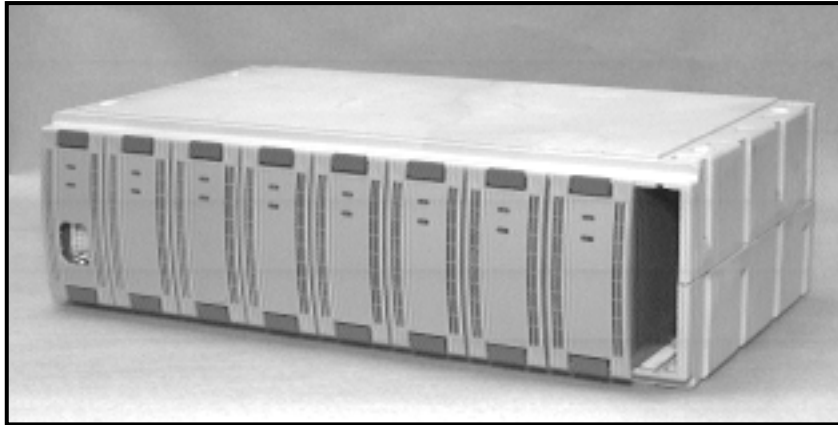

CXO-3606A-PH

- The SBB slots are numbered 0 through 7 from right to left.
- The seven available device addresses (that is, target IDs) are 0 through 6 and can be used for either 3½-inch or 5¼-inch SBBs. The shelf slot numbers and the device addresses are the same.
- Slot 6 can be used for *either* a storage SBB or an *optional* redundant dc power supply SBB.
- Slot 7 is *always* used for the primary power supply.
- The BA350–LA shelf can only be installed in a DEC 10000 AXP system cabinet.

Table 1–1 lists the DECstor/me products that can be used with a BA350–LA shelf.

Table 1–1 BA350 DECstor/me Products

DECstor/me Product	Min	Max
BA35X–HB dc power supply	1	2
3½-inch SBB	0	7
5¼-inch SBB ¹	0	2
SCSI buses	1	2
BA35X–MB SCSI terminator board	1	1
BA35X–MC SCSI jumper board	0	1
BA35X–PA filler panel kit ²	0	1
S–PIU mounting bracket kit ³	1	1

¹This SBB requires three slots.

²This kit contains six blank, 3½-inch SBB bezels.

³Included with the shelf.

1.2 Shelf Status

Two conditions are monitored for the shelf: cooling and power. The cabinet provides the cooling and the shelf power supply provides the +5 Vdc +12 Vdc to operate the SBBs. When there is an overtemperature condition or a power supply failure, the status is reported to the host or controller and is indicated to the user by the illumination of one or both of the power supply LEDs.

1.2.1 Power Supply LEDs

The power supply is shown in Figure 1–2. There are two status LEDs on the front of the power supply:

- The upper LED indicates the shelf status.
- The lower LED indicates the power supply status.

Depending on whether or not either or both of the LEDs are lit indicates one of the following conditions:

- When the shelf status (upper) LED is on and the power supply status (lower) LED is on, the temperature is within the proper operating range and the power supplies are functioning properly.
- When the shelf status (upper) LED is off and the power supply status (lower) LED is on, there is an overtemperature condition.
- When both the shelf status (upper) LED and the power supply status (lower) LED are off, either the power supply is defective or the input voltage is incorrect.

Figure 1–2 Power Supply LEDs

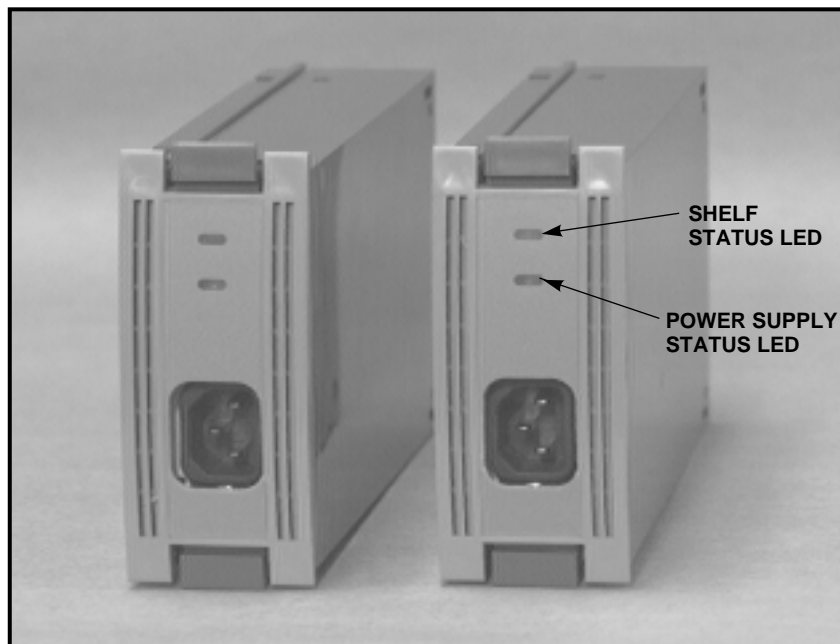

CXO-3613A-PH

Introducing the BA350–LA Shelf

1.3 Replacing SBBs

1.3 Replacing SBBs

There are three methods for replacing SBBs, including power supplies—hot swap, warm swap, and cold swap. A full description of these procedures is contained in the *BA350 Modular Storage Shelf Subsystem User's Guide*.

CAUTION

To prevent electrostatic discharge (ESD) damage to an SBB, do not touch the SBB connector.

In each case, you use the LEDs on the front of the SBB to determine which SBBs are operational and which have failed.

- Use the hot swap method *only* when there are two dc power supplies in a shelf. You can remove the failed power supply while the other furnishes the power.

CAUTION

When removing or replacing an SBB, always use both hands to support the weight of the SBB.

For storage SBBs, you can use the hot swap method provided that the green status LED is off, indicating the unit is not being accessed.

- Use the warm swap method when there are multiple shelves in a cabinet and it is necessary to remove power from a particular shelf because the power supply has failed. When this is case, none of the devices on that shelf are operational until the replacement supply is installed.
- Use the cold swap method when input power is removed from all shelves in an cabinet by turning off power at the power controller. This normally only occurs during initial installation. None of the shelves are operational until the input power is restored.

To remove or replace an SBB, use the following procedure:

Step	Procedure
1.	Press the two mounting tabs (as shown in Figure 1–3) to release the SBB and pull the SBB out of the shelf.
2.	Insert the replacement SBB into the guide slots and push it in until the tabs lock in place.

Introducing the BA350–LA Shelf 1.3 Replacing SBBs

Figure 1–3 Removing an SBB from the Shelf



CXO-3611A-PH

Configuring the BA350–LA Shelf

This chapter describes the rules for configuring a BA350–LA modular storage shelf including power, system building blocks (SBBs), and device addresses.

Note

The configuration rules in the following sections have precedence over those listed in the *BA350 Modular Storage Shelf Subsystem User's Guide*.

2.1 Power Configuration Rules

Use the following rules to configure the power for a BA350–LA modular storage shelf:

- Each BA350–LA shelf requires one BA35X–HB dc primary power supply.
- The primary dc power supply is installed in slot 7 (power slot).
- When slot 6 does not contain a storage SBB, an *optional* redundant dc power supply can be installed.

2.2 SBB Configuration Rules

Use the following rules to configure the SBBs (disk drives, tape drives, and so forth) in the BA350–LA shelf:

- The Digital storage devices available for use in the BA350–LA shelf are listed in *BA350 Modular Storage Shelf Subsystem Configuration Guide*.
- The maximum number of SBBs you can install in a BA350–LA modular storage shelf is determined by:
 - The SBB physical size (either 3½-inch or 5¼-inch)
 - The bus configuration
- Software control signals on the SCSI bus are required to ensure that the disk drives on each shelf spin up *sequentially*.
- The sequence for installing storage SBBs is determined by the SCSI bus configuration.

CAUTION

To prevent ESD damage to an SBB, do not touch the SBB connector.

Configuring the BA350–LA Shelf

2.3 SBB Device Addressing Rules

2.3 SBB Device Addressing Rules

Use the following rules to assign device addresses to the SBBs (disk drives, tape drives, and so forth) in a DECstor/me shelf:

CAUTION

Each device address on a SCSI bus or DECstor/me storage shelf can only be used once.

- The maximum number of device addresses per SCSI bus or DECstor/me modular storage shelf is seven.
- The SBB device address is determined automatically by its physical location in the shelf unless the SBB has a device address switch.

Note

Unless specifically stated otherwise, DECstor/me modular storage shelf slot numbers and SCSI addresses are the same.

- The 3½-inch tape drive SBBs and all 5¼-inch SBBs have a six-bit address switch located on the rear of the SBB as shown in Figure 2–1. With this switch you can select a SCSI address in the range 0 through 7. Table 2–1 lists the valid device address switch positions.
- Setting the switch to automatic, as described in Table 2–1, enables the automatic addressing mode which uses the physical position of the SBB to determine the address.
- When there is no address switch or you set the switch to automatic, the SBB connector position determines the SCSI device address. For example,
 - If the SBB connector is in slot 5, the device address is 5.
 - If the SBB connector is in slot 3, the device address is 3.
- The address switch for a 5¼-inch full-height (FH) SBB is mounted adjacent to the center SBB connector.
- The address switch for the lower 5¼-inch half-height (HH) SBB is mounted adjacent to the center SBB connector.
- The address switch for the upper 5¼-inch HH SBB is mounted adjacent to the left SBB connector.

Configuring the BA350-LA Shelf

2.3 SBB Device Addressing Rules

Table 2-1 DECstor/me SBB Address Switch Settings

	SCSI Switch Number					
	1	2	3	4	5	6
SCSI address 0	Off	Off	Off	Off	Off	Off
SCSI address 1	On	Off	Off	Off	Off	Off
SCSI address 2	Off	On	Off	Off	Off	Off
SCSI address 3	On	On	Off	Off	Off	Off
SCSI address 4	Off	Off	On	Off	Off	Off
SCSI address 5	On	Off	On	Off	Off	Off
SCSI address 6	Off	On	On	Off	Off	Off
SCSI address 7 ¹	On	On	On	Off	Off	Off
Automatic	Off	Off	Off	On	On	On

¹SCSI address 7 is generally reserved for the host.

Figure 2-1 SBB Device Address Switch

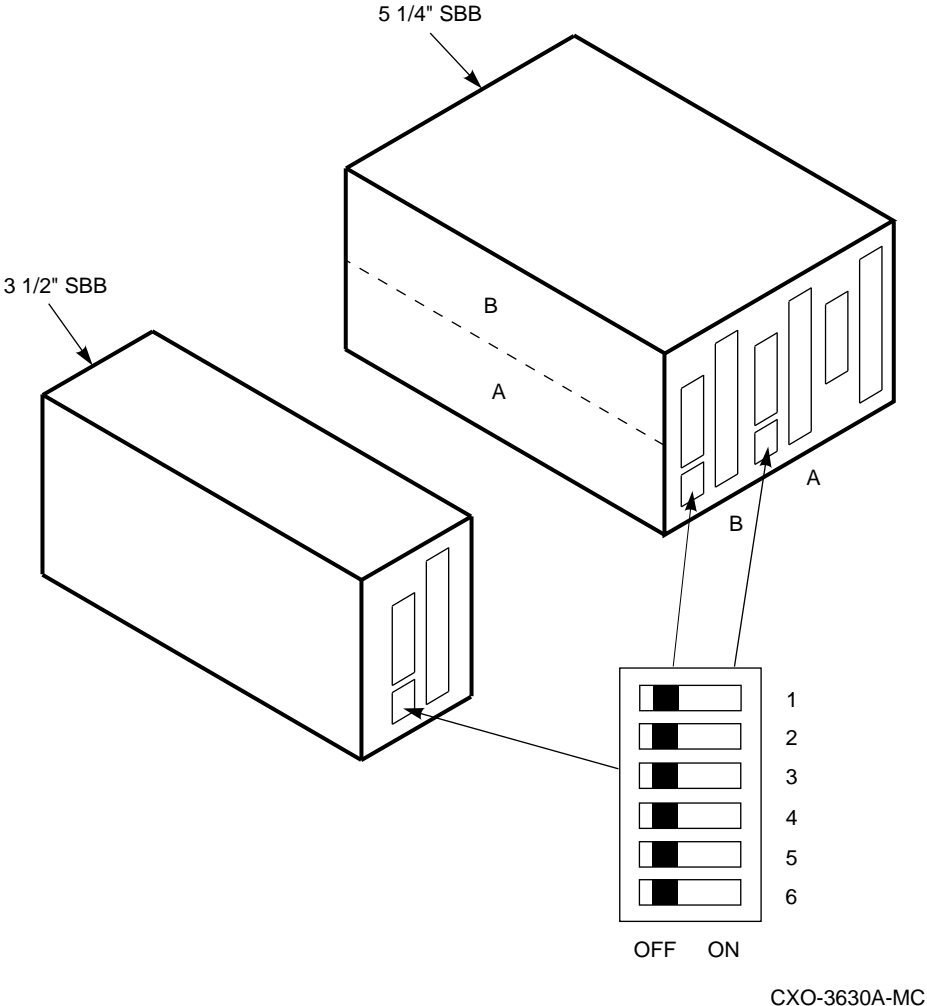

BA350–LA Shelf SCSI Buses

This chapter describes the BA350–LA modular storage shelf SCSI buses including terminators, jumpers, and component locations.

WARNING

Service procedures described in this manual that involve blower removal or access to the rear of the shelf must be performed only by qualified service personnel.

To reduce the risk of electrical energy hazard, disconnect the power cables from the shelf power supplies before removing shelf blower assemblies or performing service in the backplane area, such as modifying the SCSI bus.

3.1 SCSI Bus Configuration Rules

Use the following rules to configure the BA350–LA shelf SCSI buses:

- As shown in Figure 3–1, the BA350–LA has two single-ended SCSI bus connectors mounted at the right end.

Figure 3–1 BA350–LA SCSI Buses

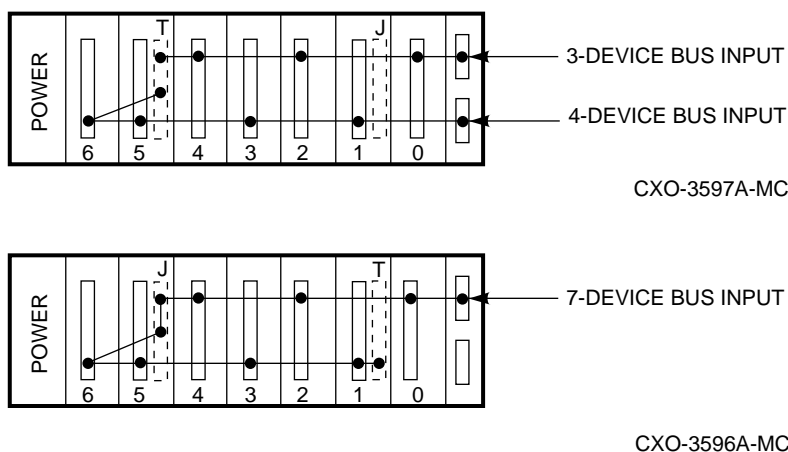

- Each bus requires a terminator. The terminator (T) and jumper (J) connectors are mounted on the rear of the backplane.

BA350–LA Shelf SCSI Buses

3.1 SCSI Bus Configuration Rules

- The BA350–LA shelf SCSI buses are configured prior to shipment as either a four-SBB bus and a three-SBB bus, or a seven-SBB bus. (Refer to Figure 3–1.) The configuration is determined by the customer’s requirements.
- Customers can configure buses provided that the rules listed in the following sections are strictly observed. For a complete listing of compatible SCSI cables, see the *BA350 DECstor/me Modular Storage Shelf Subsystem User’s Guide*.
- Each device address on a SCSI bus can only be used once.

3.1.1 Configuring a BA350–LA Shelf for a Single SCSI Bus

To configure the BA350–LA shelf for a single SCSI bus, as shown in Figure 3–2, use the following procedure:

Step	Procedure
1.	Turn off the shelf power by disconnecting the power cable from the shelf power supplies.
2.	Discharge any static buildup by momentarily touching a finger to a blank space on the backplane.
3.	Install the BA35X–MB terminator board in the backplane connector behind slot 1.
4.	Install the BA35X–MC jumper board in the backplane connector behind slot 5.
5.	Connect the SCSI cable to the upper connector.
6.	Turn on the power and verify that all the devices are active.

Figure 3–2 Single BA350–LA Shelf for One SCSI Bus

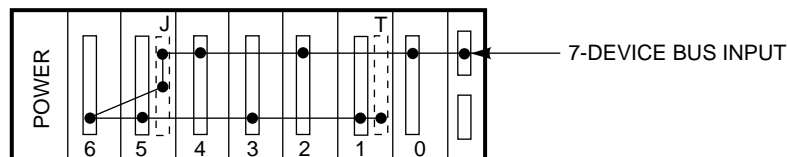

CXO-3596A-MC

BA350–LA Shelf SCSI Buses

3.1 SCSI Bus Configuration Rules

3.1.2 Configuring a BA350–LA Shelf for Two SCSI Buses

To configure the BA350–LA shelf for two SCSI buses, as shown in Figure 3–3, use the following procedure:

Step	Procedure
1.	Turn off the shelf power by disconnecting the power cable from the shelf power supplies.
2.	Discharge any static buildup by momentarily touching a finger to a blank space on the backplane.
3.	Install the BA35X–MB terminator board in the backplane connector behind slot 5.
4.	Install the unused BA35X–MC jumper board in the backplane connector behind slot 1.
5.	Connect the SCSI cable for device addresses 0, 2, and 4 to the upper connector.
6.	Connect the SCSI cable for device addresses 1, 3, 5, and 6 to the lower connector.
7.	Turn on the power and verify that all the devices are active.

Figure 3–3 Single BA350–LA Shelf for Two SCSI Buses

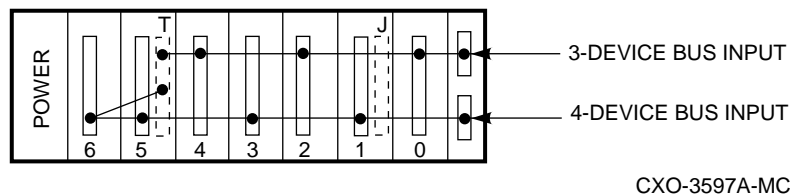

BA350–LA Shelf SCSI Buses

3.1 SCSI Bus Configuration Rules

3.1.3 Configuring Multiple BA350–LA Shelves for a Single SCSI Bus

To configure two BA350–LA shelves as a single SCSI bus, as shown in Figure 3–4, use the following procedure:

Note

The maximum number of BA350–LA shelves on a single SCSI bus is two. A maximum of seven SBBs can be installed in each shelf.

Step	Procedure
1.	Turn off the shelf power by disconnecting the power cable from the shelf power supplies.
2.	Discharge any static buildup by momentarily touching a finger to a blank space on the backplane.
3.	On the upper shelf, install the BA35X–MC jumper board in the backplane connector behind slot 5.
4.	On the lower shelf, install the BA35X–MC jumper board in the backplane connector behind slot 5.
5.	On the lower shelf, install the BA35X–MB terminator board in the backplane connector behind slot 1.
6.	Connect the SCSI cable between the lower connector on the upper shelf and the upper connector on the lower shelf.
7.	Ensure that each device has a different SCSI bus address.
8.	Turn on the power and verify that all the devices are active.

Figure 3–4 Single SCSI Bus on Two BA350–LA Shelves

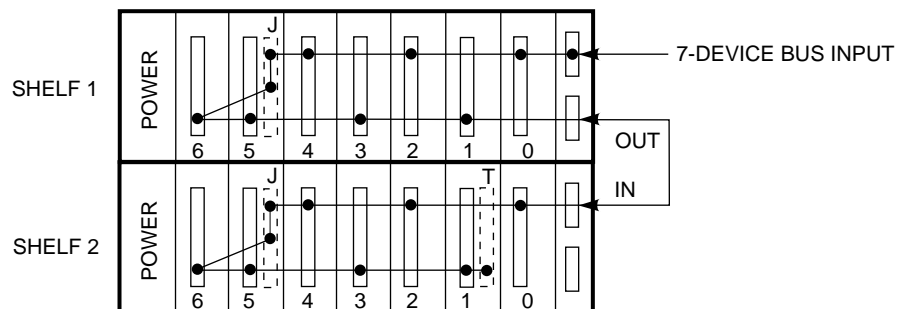

CXO-3598A-MC

C

- Configuration rules
 - multiple BA350–LA shelves, 3–4
 - power supply, 2–1
 - SBBs, 2–1
 - SCSI bus, 3–1
 - single SCSI bus, 3–2
 - single SCSI bus, multiple shelves, 3–4
 - two SCSI buses, 3–3
- Cooling requirements, 1–1

D

- DECstor/me products used with the BA350–LA shelf, 1–2
- Description, 1–1
 - cooling, 1–1
 - power supply, 1–1
 - SCSI bus, 3–1
 - SHELF_OK status signal, 1–1

P

- Power supply
 - configuration rules, 2–1
 - requirements, 1–1

R

- Related documents, vi
- Removing SSBs
 - procedure for, 1–4
- Replacing SSBs, 1–4
 - cold swap method, 1–4
 - hot swap method, 1–4
 - procedure for, 1–4
 - warm swap method, 1–4

S

- SBBs
 - configuration rules, 2–1
- SCSI bus
 - configuration rules, 3–1
 - description, 3–1

- SCSI bus configuration, single bus
 - procedure, 3–2
- SCSI bus configuration, single bus, multiple shelves
 - procedure, 3–4
- SCSI bus configuration, two buses
 - procedure, 3–3
- Shelf status, 1–3
 - power supply LEDs, 1–3
- SHELF_OK status signal, 1–1
- SSB
 - definition, 1–1

