

# **DEC Laser 2200 Printer Operator's Guide**

Order Number EK-D2200-OP-001

**Digital Equipment Corporation  
Maynard, Massachusetts**

---

**First Printing, June 1990**

The information in this document is subject to change without notice and should not be construed as a commitment by Digital Equipment Corporation.

Digital Equipment Corporation assumes no responsibility for any errors that may appear in this document.

Any software described in this document is furnished under a license and may be used or copied only in accordance with the terms of such license. No responsibility is assumed for the use or reliability of software or equipment that is not supplied by Digital Equipment Corporation or its affiliated companies.

Restricted Rights: Use, duplication, or disclosure by the U.S. Government is subject to restrictions as set forth in subparagraph (c)(1)(ii) of the Rights in Technical Data and Computer Software clause at DFARS 252.227-7013.

© Digital Equipment Corporation 1990  
All rights reserved. Printed in U.S.A.

The Reader's Comments form at the end of this document requests your critical evaluation to assist in preparing future documentation.

The following are trademarks of Digital Equipment Corporation: BASIC Service, DECdirect, DEClaser, DECmailer, DECmate, DECserver, DECservice, DECstation, EDT, LN03, MicroVAX, PRO, Rainbow, ReGIS, VAX, VAX DOCUMENT, VAXmate, VAXstation, VAX/VMS, VMS, WPS-PLUS, VT, and the DIGITAL Logo.

The following are third-party trademarks: BITSTREAM is a registered trademark of Bitstream, Inc. Centronics is a trademark of Centronics Data Computer Corporation. GC Times is a trademark of AGFA Compugraphic Corporation. CG Triumvirate is a trademark of AGFA Compugraphic Corporation. IBM is a registered trademark of International Business Machines Corporation. IBM-PC is a trademark of International Business Machines Corporation. ITC Souvenir is a registered trademark of International Typeface Corporation. PostScript is a registered trademark of Adobe Systems, Inc. Tektronix is a registered trademark of Tektronix, Inc.

S1388

This document was prepared using VAX DOCUMENT, Version 1.2.

**FCC NOTICE:** This equipment generates and uses radio frequency energy and if not installed and used properly, that is, in strict accordance with the manufacturer's instructions, may cause interference to radio and television reception. It has been type tested and found to comply with the limits for a Class B computing device in accordance with the specifications in Subpart J of Part 15 of FCC Rules, which are designed to provide reasonable protection against such interference in a residential installation. However, there is no guarantee that interference will not occur in a particular installation. If this equipment does cause interference to radio or television reception, which can be determined by turning the equipment off and on, the user is encouraged to try to correct the interference by one or more of the following methods.

- Reorient the receiving antenna.
- Relocate the computer or peripheral with respect to the receiver.
- Move the computer or peripheral away from the receiver.
- Plug the computer or peripheral into a different outlet so that they are on different branch circuits than the receiver.

If necessary, the user should consult the dealer or an experienced radio /television technician for additional suggestions. The user may find the booklet *How to Identify and Resolve Radio/TV Interference Problems*, prepared by the Federal Communications Commission helpful. This booklet is available from the U.S. Government Printing Office, Washington DC, 20402, Stock No. 004-000-00345-4.

To meet FCC requirements a shielded parallel cable is required to connect the device to a personal computer or other Class B device.

# Contents

---

Preface	xi
---------	----

---

## Chapter 1 Printer Components

---

1.1 Functions of the Printer Components	1-1
1.2 Required Operating Space	1-10

## Chapter 2 Operating Information

---

2.1 Powering the Printer On	2-1
2.2 Powering the Printer Off	2-3
2.3 Opening the Top Cover	2-4
2.4 Closing the Top Cover	2-6
2.5 Printout Selector	2-7
2.6 Printout Selection in Simplex Mode	2-8
2.6.1 Selecting Facedown Printout (Top Output Tray)	2-9
2.6.2 Selecting Faceup Printouts (Rear Output Tray)	2-10
2.7 Printing in Duplex Mode	2-11
2.7.1 Duplex Printing Printer Setup	2-12
2.8 Loading Paper	2-14
2.8.1 Adding Paper to the Cassettes	2-15
2.9 Feeding Media Manually	2-18
2.9.1 Manually Feeding Paper, Labels, and Transparencies	2-20
2.10 Feeding Envelopes Manually	2-26
2.10.1 Feeding Envelopes	2-26
2.11 Adjusting the Print Density	2-32
2.12 Printing the Engine Test Print	2-35
2.13 Printing Test Print A	2-38
2.14 Printing Test Print B	2-42
2.15 Printing the Font List	2-45

2.16	Using Control Representation Mode . . . . .	2-48
2.16.1	Entering Control Representation Mode . . . . .	2-48
2.17	Resetting the Printer . . . . .	2-49

## Chapter 3 The Control Panel

---

3.1	Using the Keypad in Keypad Mode . . . . .	3-4
3.1.1	Entering Keypad Mode . . . . .	3-4
3.2	Using the Keypad in Menu Mode . . . . .	3-7

## Chapter 4 Printer Configuration

---

4.1	Entering Menu Mode . . . . .	4-2
4.1.1	Using the Keypad in Menu Mode . . . . .	4-3
4.2	Reading the Display in Menu Mode . . . . .	4-4
4.2.1	Displaying Menu and Feature Selections . . . . .	4-4
4.2.2	Displaying Menu Values . . . . .	4-5
4.3	Printer Configuration Memory . . . . .	4-5
4.3.1	Operating Memory . . . . .	4-6
4.3.2	ROM (Read-Only Memory) . . . . .	4-7
4.3.3	NVRAM (Nonvolatile Random-Access Memory) . . . . .	4-8
4.3.4	RAM (Random-Access Memory) . . . . .	4-9
4.4	Operational Flow in Menu Mode . . . . .	4-9
4.4.1	Sample Procedure for Changing and Saving Values . . . . .	4-11
4.5	Menu Descriptions . . . . .	4-15
4.5.1	FEEDER Menu . . . . .	4-18
4.5.2	LAYOUT Menu . . . . .	4-20
4.5.2.1	Offset Position (offsetX, offsetY) . . . . .	4-21
4.5.2.2	Automatic New Line (autoNL) . . . . .	4-23
4.5.3	COPY Menu . . . . .	4-23
4.5.4	COMMAND Menu . . . . .	4-23
4.5.5	INITIAL Menu . . . . .	4-24
4.5.5.1	Macro . . . . .	4-25
4.5.5.2	Examples Using the Macro Feature . . . . .	4-27
4.5.5.3	Paint Mode (paint) . . . . .	4-27
4.5.5.4	Paper Size (paper) . . . . .	4-27

4.5.6	INTERFACE Menu	4-28
4.5.6.1	Interface Selection (i/f)	4-29
4.5.6.2	Baud Rate (baud)	4-30
4.5.6.3	RS232C Data Format (rsmode)	4-30
4.5.6.4	Data Terminal Ready (dtr)	4-30
4.5.6.5	Buffer Control (xon/xoff)	4-30
4.5.6.6	End of Text/Acknowledge (etx/ack)	4-31
4.5.7	DUPLEX Menu	4-31

## Chapter 5 Print Media

---

5.1	Paper Specifications	5-2
5.1.1	Special Considerations When Printing on Paper	5-3
5.2	Envelope Requirements	5-4
5.2.1	Special Considerations When Printing on Envelopes	5-7
5.3	Transparencies	5-8
5.3.1	Special Considerations When Printing Transparencies	5-8
5.4	Labels	5-9
5.4.1	Special Considerations When Printing on Labels	5-10
5.5	Paper Handling and Storage	5-11
5.5.1	Paper Handling	5-11
5.5.2	Paper Storage	5-11

## Chapter 6 Troubleshooting

---

6.1	Error Skip Procedure	6-1
6.2	Printer Status Messages	6-2
6.3	Operator Call Messages	6-3
6.4	Software Error Messages	6-5
6.5	Service Call Messages	6-7
6.6	Common Operating Problems	6-7
6.6.1	Incorrect Printing Mode	6-11
6.7	Paper Jams	6-12
6.7.1	Paper Jam Areas 1, 6, and 7	6-13
6.7.2	Paper Jam Areas 2, 3, 4, and 6	6-17
6.7.3	Paper Jam Area 5 (Duplex Printing Mode Only)	6-22

6.7.4	Paper Jam Area 8 (Duplex Printing Only) . . . . .	6-26
-------	---	------

## Chapter 7 Maintenance

---

7.1	Cleaning the Printer . . . . .	7-1
7.1.1	Cleaning the Internal Surfaces . . . . .	7-2
7.1.2	Cleaning the Primary Corona Wire . . . . .	7-7
7.1.3	Cleaning the Transfer Corona Wires and Discharging Pins . . . . .	7-14
7.2	Extending EP-S Cartridge Life . . . . .	7-20
7.3	Replacing the EP-S Cartridge . . . . .	7-21
7.4	Replacing the Ozone Filter . . . . .	7-39

## Chapter 8 Service

---

8.1	Digital Equipment Corporation Services . . . . .	8-1
-----	--	-----

## Appendix A DEClaser Printer Quick Reference Guide

---

A.1	Positioning Controls . . . . .	A-2
A.2	Margins and Spacing . . . . .	A-5
A.3	Set/Reset Modes . . . . .	A-10
A.4	Fonts and Character Sets . . . . .	A-11
A.5	Miscellaneous . . . . .	A-16

## Appendix B Accessories and Supplies

---

B.1	Ordering Information . . . . .	B-3
-----	--------------------------------	-----

## Appendix C Specifications

---

C.1	Operating Specifications . . . . .	C-1
C.2	Serial Interface Specifications . . . . .	C-4
C.3	Parallel Interface Specifications . . . . .	C-7

## Appendix D LN03 Compatibility

---

D.1	General Differences . . . . .	D-1
D.2	Printable Area Compatibility . . . . .	D-2
D.3	Protocol Compatibility . . . . .	D-2

## Glossary

---

## Index

---

## Figures

---

1	CDRH Label . . . . .	xvii
1-1	Components: Front/Right-Side View . . . . .	1-2
1-2	Components: Rear/Left-Side View . . . . .	1-4
1-3	Components: Rear Output Tray . . . . .	1-6
1-4	Components: Inside the Printer . . . . .	1-8
1-5	Operating Space: Top View . . . . .	1-11
1-6	Operating Space: Side View . . . . .	1-11
2-1	Printout Selector . . . . .	2-7
2-2	Printout Selections . . . . .	2-8
2-3	Duplex Paper Path . . . . .	2-11
2-4	Engine Test Print . . . . .	2-36
2-5	Test Print A . . . . .	2-39
2-6	Test Print B . . . . .	2-43
2-7	Font List . . . . .	2-46
3-1	Control Panel . . . . .	3-1
4-1	Sample of a Menu . . . . .	4-1
4-2	Menu Display . . . . .	4-4
4-3	Operating Memory . . . . .	4-6
4-4	Operational Flow Chart . . . . .	4-10
4-5	Test Print A Verification . . . . .	4-14
4-6	Offset Positioning . . . . .	4-21
4-7	Offset Printout Samples . . . . .	4-22
5-1	Unacceptable Labels . . . . .	5-9



6-1	Paper Jam Areas . . . . .	6-12
7-1	Rocking the EP-S Cartridge . . . . .	7-21
C-1	RS232C Pin Assignments . . . . .	C-4
C-2	Serial Connections to Modem . . . . .	C-5
C-3	Serial Connections Without Modem . . . . .	C-6
C-4	Parallel Pin Assignment . . . . .	C-9
C-5	Parallel Connections . . . . .	C-9

## Tables

---

1-1	Printer Components: Front/Right-Side View . . . . .	1-3
1-2	Printer Components: Rear/Left-Side View . . . . .	1-5
1-3	Printer Components: Rear Output Tray . . . . .	1-7
1-4	Printer Components: Internal View . . . . .	1-9
2-1	Legal-Size Coding Example . . . . .	2-19
2-2	Test Print A . . . . .	2-40
2-3	Printing Test Print A . . . . .	2-41
2-4	Printing Test Print B . . . . .	2-44
2-5	Printing the Font List . . . . .	2-47
2-6	Entering Control Representation Mode . . . . .	2-48
2-7	Resetting the Printer . . . . .	2-49
3-1	Control Panel Functions . . . . .	3-2
3-2	Keypad Functions: Keypad Mode . . . . .	3-5
4-1	Entering Menu Mode . . . . .	4-2
4-2	Keypad Functions: Menu Mode . . . . .	4-3
4-3	Recalling Factory Default Values from ROM . . . . .	4-7
4-4	Saving Values in NVRAM . . . . .	4-8
4-5	Saving Values in RAM . . . . .	4-9
4-6	Changing and Saving Values . . . . .	4-11
4-7	Menu Mode Features and Values . . . . .	4-15
4-8	FEEDER Menu Features and Values . . . . .	4-19
4-9	LAYOUT Menu Features and Values . . . . .	4-20
4-10	COPY Menu Features and Values . . . . .	4-23
4-11	COMMAND Menu Features and Values . . . . .	4-23
4-12	INITIAL Menu Features and Values . . . . .	4-24
4-13	Device Identification . . . . .	4-25
4-14	User Preference Character Set . . . . .	4-26

4-15	Macro Feature Examples . . . . .	4-27
4-16	INTERFACE Menu Features and Values . . . . .	4-28
4-17	DUPLEX Menu Features and Values . . . . .	4-31
5-1	Cassette Feed Paper Sizes . . . . .	5-2
5-2	Paper Specifications . . . . .	5-3
5-3	Transparency Sizes . . . . .	5-8
5-4	Transparency Specifications . . . . .	5-8
6-1	Printer Status Messages . . . . .	6-2
6-2	Operator Call Messages . . . . .	6-3
6-3	Software Error Messages . . . . .	6-5
6-4	Service Call Messages . . . . .	6-7
6-5	Common Operating Problems . . . . .	6-8
8-1	Questions to Consider Before You Call . . . . .	8-2
A-1	DECVPFS Selective Parameters . . . . .	A-7
A-2	SCS—Select Character Set . . . . .	A-14
A-3	NRC Fallback Selection . . . . .	A-15
A-4	Selective Digital Private Parameters . . . . .	A-16
B-1	DEClaser 2200 Printer Accessories and Supplies . . . . .	B-1
B-2	Ordering Within the U.S.A. . . . .	B-3
B-3	Ordering Outside the U.S.A. . . . .	B-3
C-1	Serial Interface Pin Assignment . . . . .	C-4
C-2	Parallel Interface Pin Assignments . . . . .	C-8

## Preface

---

The DEClaser 2200 printer uses electrophotographic laser technology to print text and graphics at speeds up to 8 pages/minute with a density of 300 x 300 dots/inch. The printer consists of an engine (print mechanism) and a controller (formatter) that are driven from host-based software to provide shared printer access from the Digital network. The printer can serve as a personal desktop printer or as a shared group printer, and is designed to print from 5,000 to 12,000 prints per month.

Some of the features of the DEClaser 2200 printer include:

- Duplex (two-sided) printing capability
- Two cassette trays with automatic switching capability
- Capacity for two (optional) external Digital ANSI-compliant font cartridges
- Font downline loading capability
- Support for both serial and parallel interfaces
- Convenient user maintenance (one replaceable supply cartridge)
- Ability to print on envelopes
- Manual feeding capability

The following are some of the options available for the DEClaser 2200 printer:

- User-installable memory expansion (up to 3 MB)
- Digital ANSI-compliant font cartridges
- User-installable PostScript upgrade capability
- User-installable envelope feeder
- Envelope cassette

## Software Requirements

Some features of the DEClaser 2200 printer may or may not be available depending on the operating software used by the host computer system and the application software that you are using. For information about the printer features you can use with your application program, consult your application program documentation.

For help choosing the right software package for your application needs, contact your Digital sales representative.

## Document Structure

This guide focuses mainly on the operational aspects of the DEClaser 2200 and explains how to use and maintain the printer hardware. For printer installation instructions, refer to the *DEClaser 2200 Printer Installation Guide* in this binder.

This guide describes the printer components and their functions, such as loading paper, changing the supply cartridge, and using the operator panel. It also covers the proper maintenance procedures to keep your printer operating efficiently, and basic troubleshooting techniques for correcting common operating problems. The appendices describe accessories and supplies, operating specifications, programming information, and contain a glossary of terms.

This guide is organized as follows:

- Chapter 1, Printer Components, describes the components and features of the DEClaser 2200 printer.
- Chapter 2, Operating Information, covers operating procedures such as powering the printer on, loading paper, and adjusting print density. It also describes how to manually feed print media.
- Chapter 3, The Control Panel, covers the use of the printer's control panel. It describes operational information about the indicators, keys, and message display.
- Chapter 4, Printer Configuration, explains how to configure the printer so that it can communicate with your computer system. You configure the printer by selecting features and their associated values from the various set-up menus. This chapter also describes how to save values in memory.
- Chapter 5, Print Media, describes the various printing media that can be used with the DEClaser 2200, including paper, envelopes,

transparencies, and labels. It also addresses the proper way to store and handle paper.

- Chapter 6, Troubleshooting, contains basic testing and troubleshooting techniques that allow you to correct common operating problems such as poor printing or paper jams.
- Chapter 7, Maintenance, explains how to care for and maintain the printer. It describes how to replace the electrophotographic supply (EP-S) cartridge and ozone filter, and how to clean the printer.
- Chapter 8, Service, explains how to obtain service if the printer needs repair.
- Appendix A, DEClaser Printer Quick Reference Guide, lists the DEClaser escape sequences used to program the printer. It is intended as a reference for the experienced programmer.
- Appendix B, Accessories and Supplies, describes the accessories and supplies available for the DEClaser 2200 printer and explains how to order them.
- Appendix C, Specifications, lists the power, environmental, and physical specifications of the DEClaser 2200 printer.
- Appendix D, LN03 Compatibility, highlights the major differences between the LN03 and DEClaser 2200 printers.
- The glossary contains definitions of printer-related terms.

#### **Ordering Additional Copies of This Documentation Set**

You can order additional copies of this documentation set from DECdirect as described in the ordering information section at the end of this guide. The ordering number for the documentation is EK-D2200-DK.

The documentation set consists of one of each of the following:

- *DEClaser 2200 Printer Installation Guide*
- *DEClaser 2200 Printer Operator's Guide*
- Spine insert for the binder
- Three-ring binder

**NOTE:** *You cannot order the installation or operator's guide individually. You can only order the documentation set.*

## Associated Documents

Several other related manuals are available for use with the DEClaser 2200 printer. You can order these optional manuals from DECdirect as described in the ordering information section at the end of this guide.

Those optional manuals are:

- *Digital ANSI-Compliant Printing Protocol Level 3 Programming Reference Manual* (AA-PBWGA-TE)  
This manual is for application programmers who create software that produces Digital ANSI-compliant level 3 output. It describes printer protocol character processing and printer control functions.
- *Digital ANSI-Compliant Printing Protocol Level 3 Programming Supplement* (AA-PBWHA-TE)  
Contains device specific information for programmers who create applications for Digital's ANSI-compliant level 3 devices. It is also for programmers who write applications with ANSI output that requires conversion to the PostScript page description language for printing on Digital printers.
- *PostScript Translators Reference Manual for ReGIS and Tektronix 4010 /4014* (AA-PBWFA-TE)  
This manual is for programmers who need to convert ReGIS or Tektronix 4010/4014 documents to PostScript for printing on PostScript printers. The DEClaser 2200 has a PostScript option and can print Tektronix 4010/4014 and ReGIS files using the Common Print Symbiont (CPS).
- *Digital Laser Printers Guide to Paper and Other Media* (EK-LASER-GD)  
This manual is for general users and contains detailed information about buying and storing print media (paper, envelopes, labels, and transparencies) that can be used with Digital laser printers.

## Conventions Used in This Guide

The following terms and conventions are used in this guide:

Convention	Meaning
NOTE	Notes provide important additional information.
CAUTION	Cautions provide information required to prevent damage to equipment.
WARNING	Warnings provide information to prevent personal injury.
Dash (—)	<p>A statement preceded by a dash describes the result of a procedural step. For example:</p> <ol style="list-style-type: none"><li>1. Insert the paper cassette by sliding it straight into the cassette slot.</li></ol> <p>— The Alarm indicator shuts off.</p> <p>— The display reads 00 READY.</p>
Check Mark (✓)	<p>A statement marked by a check mark indicates a special instruction related to a procedural step. For example:</p> <ol style="list-style-type: none"><li>1. Add paper to the cassette by placing it into the left side first, being sure the paper is inserted below the paper guide and maximum height guard.</li></ol> <p>✓ To prevent paper jams, do not load too much paper into the cassette. Leave a small amount of space between the paper and the maximum height guard.</p> <p>✓ Make sure the paper lies perfectly flat in the cassette.</p>
<span style="border: 1px solid black; padding: 2px;">Key</span>	<p>A key name is shown enclosed in a box to indicate that you press that key on the control panel. Key names are always shown in initial capital letters. For example:</p> <ol style="list-style-type: none"><li>1. Press <span style="border: 1px solid black; padding: 2px;">Menu</span> to access the printer menu selections.</li></ol>
UPPERCASE	<p>Printer status messages and operator call messages are shown in uppercase. For example:</p> <p>— The display reads 00 READY.</p> <p>— The display reads 11 PAPER OUT.</p>

Convention	Meaning
<b>Bold</b>	<p>Items from the scrolling menus appear as they do on the display (uppercase, lowercase, or initial capital letters) with the menu item shown in bold type. For example:</p> <ol style="list-style-type: none"> <li>1. Press <b>Menu</b> to enter Menu Mode. <ul style="list-style-type: none"> <li>— The menu display reads <b>FONT/FEED LAYOUT</b>.</li> </ul> </li> </ol>

## Safety Information

The DEClaser 2200 printer complies with all United States government safety regulations applicable to ozone gas emissions and laser beam light exposure. Read the following information to become familiar with ozone and laser safety.

### Ozone Safety

Ozone is a colorless gas (O<sub>3</sub>) that is a by-product of the electrophotographic process. The DEClaser printers use an ozone filter to remove the ozone generated by the printer. The ozone filter is replaced at 100,000 page intervals. See Appendix B for ordering information.

**WARNING:** *Be sure to replace the ozone filter every 100,000 pages, and never operate the printer without the ozone filter in place. The filter removes ozone that could be hazardous to your health.*



## Laser Safety

The DEClaser 2200 printer complies with 21 CFR Chapter 1, Subchapter J, as a Class 1 laser product under the U.S. Department of Health and Human Services (DHHS) Radiation Performance Standard according to the Radiation Control for Health and Safety Act of 1968. The printer does not emit hazardous light since the laser beam is totally enclosed during all modes of customer operation and maintenance.

**WARNING:** *Use of controls or adjustment procedures other than those specified in this manual may result in hazardous laser light exposure.*

## CDRH Regulations

The Center for Devices and Radiological Health (CDRH) of the U.S. Food and Drug Administration implemented regulations for laser products on August 2, 1976. These regulations apply to laser products manufactured beginning August 1, 1976. Compliance is mandatory for products marketed in the United States. The label shown in Figure 1 indicates compliance with the CDRH regulations and must be attached to laser products marketed in the United States.

**Figure 1: CDRH Label**

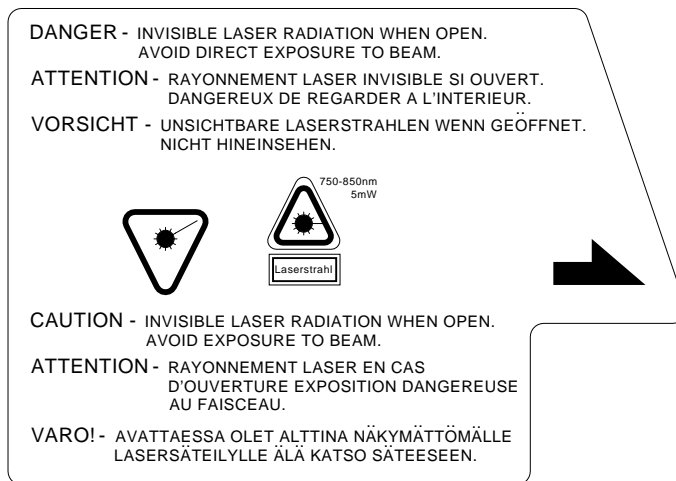

MLO-004945

**NOTE:** *This label is attached to the laser scanner unit inside the printer.*

# Chapter 1

## Printer Components

---

This chapter describes the components of the DEClaser 2200 printer and their functions. This chapter also provides information about the operating space required to perform day-to-day printing operations.

### 1.1 Functions of the Printer Components

Figure 1-1, Figure 1-2, Figure 1-3, and Figure 1-4 show the printer components. Table 1-1, Table 1-2, Table 1-3, and Table 1-4 explain the printer components and their functions.

**Figure 1–1: Components: Front/Right-Side View**

MLO-005110 (Figure 1-1; 14.5 picas)

**Table 1–1: Printer Components: Front/Right-Side View**

<b>Component</b>	<b>Function</b>
1. Top Output Tray	Printed sheets are automatically collated and stacked (facedown) here.
2. Top Cover Release Button	Pressing this button unlocks the top cover so it can be opened. The top cover is opened to perform certain printer functions such as adding a new EP-S <sup>1</sup> cartridge or clearing a paper jam. See Section 2.3 for more information about opening the top cover.
3. Carrying Grip Plate	The carrying grip plates are located on the right and left sides of the printer. These plates are grooved to provide a nonslip surface when you are lifting the printer. Always place your hands under the carrying grip plates when lifting the printer.
4. Test Print Button	This button is used to print the Engine Test Print. The button is recessed. To depress it use a ballpoint pen or similar instrument. See Section 2.12 for more information about printing the Engine Test Print.
5. Control Panel	The control panel consists of a message display, indicator lights, and a keypad. The control panel provides information on printer status and can be used to perform certain printer functions such as resetting the printer or configuring the printer menus. See Chapter 3 for additional information about using the control panel while printing. Chapter 5 has information about using the control panel to change the various printer menus.
6. Font Cartridge Slots	These two slots accept the optional font and emulation program cartridges available for the printer.
7. Upper and Lower Paper Cassettes	The paper cassettes automatically feed paper to the printer. Each cassette can hold approximately 200 sheets of 20 lb. (75 g/m <sup>2</sup> basis weight) paper. See Section 2.8 for more information about loading paper in the cassettes.
8. Manual Feed Guide	The manual feed guide is part of the paper cassette cover. The feed guide allows you to manually feed paper, envelopes, transparencies, and labels into the printer. For more information about feeding print media manually, see Section 2.9.

---

<sup>1</sup>EP-S stands for electrophotographic supply.

---

**Figure 1–2: Components: Rear/Left-Side View**

MLO-005111 (Figure 1-2; 12.5 picas)

**Table 1–2: Printer Components: Rear/Left-Side View**

<b>Component</b>	<b>Function</b>
1. Power Switch	Powers the printer on or off. Pressing “I” turns power on; pressing “O” turns power off. To ensure that data is not lost, always be sure the display reads 00 READY and the Data indicator is off before you power off the printer. See Section 2.1 and Section 2.2 for additional information about powering the printer on and off.
2. Rear Output Tray	The rear output tray is selected when you are using certain types of print media such as transparencies and labels. It can also be used when you want printed output to be stacked faceup. Refer to Section 2.6.2 for information about choosing the different output trays.
3. Memory Board Access Cover	Additional RAM (random-access memory) can be added to the printer in 1, 2, or 3 MB capacities. This access cover allows you to easily install the extra memory board. Refer to the documentation that comes with the optional memory board for installation instructions.
4. Paper Jam Access Cover	Opening this access cover allows you to remove paper jammed in the lower paper path. See Section 6.7 for more information about clearing paper jams.
5. Parallel (Centronics) Interface Cable Connector	This connector is used when the interface cable from the host computer is a parallel cable. Refer to the <i>DECLaser 2200 Printer Installation Guide</i> for more information about connecting your computer to the printer.
6. Serial (RS232) Interface Cable Connector	This connector is used when the interface cable from the host computer is a serial cable. Refer to the <i>DECLaser 2200 Printer Installation Guide</i> for more information about connecting your computer to the printer.
7. Power Cord Receptacle	This is where the power cord is connected to the printer.

**Figure 1-3: Components: Rear Output Tray**

MLO-005112 (Figure 1-3; 15.5 picas)

**Table 1–3: Printer Components: Rear Output Tray**

<b>Component</b>	<b>Function</b>
8. Extension Tray	Must be extended when printing documents faceup. See Section 2.6.2 for information about using the extension tray.
9. Paper Jam Clearance Lever	Lifting this lever allows you to access paper jams in the rear output tray area. See Section 6.7 for more information about clearing paper jams.
10. Printout Selector	Selects the rear output tray for faceup documents, or the top output tray for facedown documents when the printer is in simplex mode. The duplex position is used when the printer is in duplex mode and delivers paper facedown to the top output tray.  <b>NOTE:</b> <i>The printer “beeps” if you try to select duplex mode and the printout selector is not set to the duplex position. The printout selector must be set to the duplex position to print in duplex mode.</i>
11. Paper Support Guide	This guide is raised during printing in duplex mode (Section 2.7). The guide supports the paper as it moves over the rear output tray during the reversing cycle.



**Figure 1-4: Components: Inside the Printer**

MLO-005113 (Figure 1-4; 30.5 picas)

**Table 1–4: Printer Components: Internal View**

<b>Component</b>	<b>Function</b>
1. Print Density Dial	Has a range of 1–9 to adjust the print density. Selecting the lower numbers results in heavier or darker print density. For most printing applications the dial can be set to 7. See Section 2.11 for additional information about setting the print density.
2. Cleaning Brush	The (green) cleaning brush has two cleaning surfaces: The brush end, which is used to clean the discharging pins on the transfer corona assembly; and the fabric end, which is used to clean the primary corona wire in the EP-S cartridge. See Chapter 7 for more information about using the cleaning brush.
3. Fixing Assembly	The fixing assembly consists of a heat roller, a pressure roller, and a roller cleaner. Toner is bonded to the paper as it passes between the heat and pressure rollers. The roller cleaner removes excess toner that may accumulate on the heat roller. The roller cleaner is replaced each time a new EP-S cartridge is installed. Each EP-S cartridge comes with replacement instructions, or you can refer to Section 7.3 for more information about replacing the roller cleaner.
4. EP-S Cartridge	The EP-S cartridge contains a photo-sensitive drum, the primary charge corona wire, a drum cleaning blade, toner, and a toner application roller. When the 16 TONER LOW message is displayed, it could mean that the toner is not being distributed evenly. Rock the cartridge to redistribute the toner (see Section 7.3). If the 16 TONER LOW message continues to be displayed after you rock the cartridge, it means the EP-S cartridge has run out of toner and you should replace it (see Section 7.3).
5. Ozone Filter	Removes ozone generated by the printer. The ozone filter is replaced every 100,000 pages. The page count is shown on Test Print A (see Section 2.13). See Section 7.4 for replacement instructions.  <b>WARNING:</b> <i>Do not operate the printer without the ozone filter in place. The filter removes ozone that could be hazardous to your health.</i>

**Table 1–4 (Cont.): Printer Components: Internal View**

<b>Component</b>	<b>Function</b>
6. Transfer Corona Assembly	Contains a corona wire that places a negative charge on the paper as it passes over the wire. This negative charge attracts the (positively charged) toner from the photo-sensitive drum in the EP-S cartridge to the paper. Keep the transfer corona wire clean at all times to ensure optimum print quality. See Section 7.1.3 for information about cleaning the transfer corona wire.
7. Paper Transfer Guide	Ensures that paper is properly routed from the cassette to the transfer corona assembly. You can also open the paper transfer guide to access paper jams that occur in that area. Lift the green handle to remove the jammed paper.

## 1.2 Required Operating Space

Always allow ample space around the printer to perform day-to-day printing operations. Figure 1–5 shows the minimum amount of space required to perform these operations. See the *DEClaser 2200 Printer Installation Guide* for additional information about location requirements and environmental conditions.

**Figure 1–5: Operating Space: Top View**

MLO-005115 (Figure 1-5; 15 picas)

**Figure 1–6: Operating Space: Side View**

MLO-005114 (Figure 1-6; 12 picas)

## Chapter 2

# Operating Information

---

This chapter provides the operating information necessary to perform day-to-day printer operations. It covers typical tasks such as adding paper, selecting an output tray, or powering the printer on and off. This chapter also covers manual feed operation for all print media.

### 2.1 Powering the Printer On

Power the printer on using the following procedure.

1. Press the power switch on the back of the printer to the | (ON) position.

MLO-005116 (Figure 2-1; 16 picas)

You should observe the following when you power on the printer:

- All control panel indicators light for a moment.
- The Ready indicator flashes and the display reads 02 WARMING UP (assuming that the printer has cooled below operating temperature before it is powered on).

- The Online and Ready indicators remain on and the display reads 00 READY DEC.

**NOTE:** *The display reads 00 READY DEC only if you are using Digital's ANSI-compliant printing protocol, which is the factory default setting. If you are using an optional protocol such as PostScript or CaPSL, the display shows the protocol being used. For instance, if you are using PostScript protocol, the display reads 00 READY PS. Since several protocols can be used with the DEClaser 2200 printer, the remainder of this manual shows the message as 00 READY.*

If the printer does not power on correctly, refer to Chapter 6 for troubleshooting information.

## 2.2 Powering the Printer Off

Power the printer off using the following procedure.

1. Be sure the printer is not printing and that the Data indicator is not on.

**CAUTION:** *Do not power the printer off while it is printing. Powering the printer off during printing causes paper jams and loss of data. Powering the printer off while the Data indicator is on causes the data in the print buffer to be lost.*

2. Press the power switch on the back of the printer to the O (OFF) position.

MLO-005117 (Figure 2-2; 15 picas)

**NOTE:** *After powering the printer off, always wait at least two seconds before you power the printer back on. This waiting period ensures that the printer will initialize (cycle) properly when it is powered back on.*

## **2.3 Opening the Top Cover**

Open the top cover using the following procedure.

1. Press the release button forward and then down.
  - The top cover releases and opens slightly.

MLO-005118 (Figure 2-3; 15.5 picas)



2. Lift the top cover open to the halfway position (about 30°) or to the upright position (about 90°).

MLO-005119 (Figure 2-4; 12 picas)

- ✓ The halfway position is intended for:
  - Replacing the EP-S cartridge
  - Adjusting the print density dial
  
- ✓ The upright position is intended for:
  - Replacing the fixing roller cleaner
  - Replacing the ozone filter
  - Clearing paper jams
  - Cleaning the inside of the printer

## **2.4 Closing the Top Cover**

Close the top cover using the following procedure.

1. Gently lower the cover and push down on the hand grip until the cover latches securely in place.

MLO-005120 (Figure 2-5; 16 picas)

## 2.5 Printout Selector

The printout selector (located on the rear paper tray) allows you to choose the output tray for the type of jobs you are printing. You can place the selector in one of two positions as shown in Figure 2-1.

**Figure 2-1: Printout Selector**

MLO-005121 (Figure 2-6; 16 picas)

The duplex/facedown position (top output tray) and the faceup position (rear output tray), can be used when the printer is in simplex mode (see Section 2.6.2 and Section 2.6.1).

The duplex/facedown position has a secondary function that serves as the duplex print position during printing in duplex mode. In duplex mode, the rear output tray is used as a paper reversing area before the paper is fed back into the printer. The printout selector must be in the duplex/facedown position to print in duplex mode, and paper is always delivered to the top output tray (see Section 2.7).

## 2.6 Printout Selection in Simplex Mode

Printed paper is delivered and stacked either facedown or faceup depending on the printout position selected (Figure 2-2). When faceup is selected, printed paper is delivered faceup to the rear output tray. Although the rear output tray can be used to stack paper faceup from a cassette, it is used primarily to stack manually fed envelopes, transparencies, labels and heavier weight (thicker) papers. See Section 2.9 for information about manually feeding print media.

When duplex/facedown is selected, printed paper is delivered facedown to the top output tray. Your print job is collated in the correct page order when it is delivered to the top output tray.

**NOTE:** *You cannot select the printout delivery (faceup or duplex/facedown) through a command from the host computer; positioning the printout selector is the only way to select the printout delivery for all modes of operation.*

### Figure 2-2: Printout Selections

MLO-005122 (Figure 2-7; 19 picas)

**CAUTION:** *Do not try to change the printout selector while the printer is printing. Changing the printout selector during printing causes paper jams.*

### **2.6.1 Selecting Facedown Printout (Top Output Tray)**

Use the following procedure to select the top output tray for facedown printing.

1. Set the printout selector to the duplex/facedown position.

MLO-005123 (Figure 2-8; 16 picas)

2. Fold in the extension tray.

MLO-005124 (Figure 2-9; 16 picas)

## **2.6.2 Selecting Faceup Printouts (Rear Output Tray)**

Use the following procedure to select the rear output tray for faceup printing.

1. Set the printout selector to the faceup position.

MLO-005126 (Figure 2-10; 16 picas)

2. Fold out the extension tray.

MLO-005125 (Figure 2-11; 16 picas)

## 2.7 Printing in Duplex Mode

Figure 2-3 shows the paper path used during printing in duplex mode. The duplex mode can be selected using a command from the host computer, or by using  Duplex on the control panel.

**NOTE:** *Although you can select duplex mode using a command from the host computer, you cannot select the printout delivery (faceup or duplex/facedown) from the host; positioning the printout selector is the only way to select the correct printout delivery.*

### Figure 2-3: Duplex Paper Path

MLO-005127 (Figure 2-12; 15.5 picas)

The following restrictions apply during printing in duplex mode:

- You cannot feed envelopes.
- You cannot feed paper manually.

### **2.7.1 Duplex Printing Printer Setup**

Use the following procedure to set the printer up for duplex printing.

1. Set the printout selector to the duplex print position.

MLO-005128 (Figure 2-13; 16 picas)

2. Lift the paper support guide up from under the rear output tray.

MLO-005129 (Figure 2-14; 16 picas)



3. Press **On Line** to place the printer off line.
  - The On Line indicator shuts off.
4. Press **Duplex** to place the printer in duplex mode.
  - The Duplex indicator lights.

**NOTE:** *If the printer “beeps” and the Duplex indicator does not light, the printer is probably in the manual feed mode. Check to see that the Feeder Menu is not set to the manual feed mode (see Section 4.5.1).*

5. Press **On Line** to place the printer back on line.
  - The On Line indicator lights.

## 2.8 Loading Paper

The printer comes standard with either A4-size (210 mm x 297 mm) or letter-size (8 ½" x 11") paper cassettes, depending on the country it is shipped to. Optional paper cassettes are available that can accommodate the following print media:

- Legal-size paper (8 ½" x 14")
- Executive-size paper (7 ¼" x 10 ½")
- Envelopes

For ordering information about optional paper cassettes, see Appendix B.

Each paper cassette can hold approximately 200 sheets of 75 g/m<sup>2</sup> basis weight (20 lb.) paper. Each cassette incorporates a convenient paper feed guide on its cover that can be used to manually feed paper, envelopes, transparencies, and labels. See Section 2.9 for information about feeding print media manually.

Here are some general guidelines about the paper used in the printer.

- Use only high-quality paper such as the papers listed in Appendix B.
- Avoid using any paper that is creased, folded, punched, clipped, stapled, or damaged.
- To prevent paper curl (a curved bend in the paper), stack the paper on a flat surface for storage.
- Prevent changes to the moisture content of the paper by storing it properly and rewrapping unused portions. Do not store paper directly on the floor.

Complete specifications for print media are in Chapter 5. For more detailed information, consult the *Digital Laser Printers Guide to Paper and Other Media* (see Appendix B for ordering information).

### 2.8.1 Adding Paper to the Cassettes

Add paper to the cassettes using the following procedure.

1. Check to see that the printer is not printing and that the display reads 00 READY before you remove the paper cassette. If the printer has run out of paper, the display reads 11 PAPER OUT or 17 U<- ->L FEED.

**CAUTION:** *Do not remove the paper cassette while the printer is printing. Removing the paper cassette during printing can damage the printer.*

2. Remove the empty cassette by pulling it straight out from the printer.
  - The display reads 11 PAPER OUT or 17 U<- ->L FEED.
  - The Alarm indicator lights.

MLO-005130 (Figure 2-15; 16 picas)

3. Remove the cassette cover by lifting it off.

MLO-004838 (Figure 2-16; 12.5 picas)

4. Insert paper into the left side of the cassette first, being sure it is inserted below the paper guide and maximum height guard.
  - ✓ To prevent paper jams, do not load too much paper into the cassette. Leave a small amount of space between the paper and the maximum height guard.
  - ✓ Make sure the paper lies perfectly flat in the cassette.

MLO-004839 (Figure 2-17; 13 picas)

5. Replace the cover on the cassette.

MLO-004840 (Figure 2-18; 13.5 picas)

6. Insert the paper cassette into the printer.
  - The Alarm indicator shuts off.
  - The display reads 00 READY.

MLO-005131 (Figure 2-19; 13.5 picas)

## 2.9 Feeding Media Manually

The paper feed guide on the cover of the cassette enables you to manually feed paper, labels, transparencies, and envelopes into the printer. The paper feed guide also allows you to print on odd-size paper that cannot be used in the cassette.

**NOTE:** *You cannot feed media manually when the printer is in the duplex mode of operation.*

Although labels and transparencies are usually fed manually, high-quality labels and transparencies, such as those sold through DECdirect, can also be fed automatically from the cassette. Check the media specifications in Chapter 5 for additional information about labels and transparencies.

Not all media can be fed automatically from the cassette. You must feed the following print media into the printer manually:

- Nonstandard-sized papers from 100 mm x 190 mm (3.9" x 7 ½") to 216 mm x 356 mm (8 ½" x 14") that do not fit in the cassette).
- Thicker papers whose basis weight is from 84 g/m<sup>2</sup> to 135 g/m<sup>2</sup> (22 lb. to 36 lb.)
- Envelopes (unless you are using the special envelope cassette)

You can invoke manual feed operation in three ways:

- Using the Feeder Select key on the control panel.
- Selecting the Manual value in the Feeder Menu.
- Sending a command from the host computer.

When feeding paper manually, you need to tell the printer the paper size you are using so that printing occurs in the proper area on the page. For A4 and letter-size paper you can set the paper (size) feature in the INITIAL Menu (Table 4–12). The paper feature sets up the printing coordinates for manual feed operation according to the value selected: either A4 or Letter. This allows the printer to print within the correct boundaries on the sheet of paper.

For paper sizes other than A4 or letter, you must use commands from the host computer that tell the printer the paper size you are using. These commands tell the printer where to print on the page. An example of this would be printing on legal-size paper. Since the printer does not recognize the larger legal-size paper, you must send it the proper commands (escape sequences) to print correctly on the page. These commands should precede the data in the file to be printed.

The following command line contains instructions to print on legal-size paper in manual feed mode. This example is set up to print a file on an 8 ½" x 14" sheet of paper in portrait mode using manual feed. Table 2–1 describes each escape sequence in the example.

```
<ESC>[7I <ESC>[99;2;2500;4200 { <ESC>[8J <ESC>[99!v
```

**Table 2–1: Legal-Size Coding Example**

Escape Sequence	Name of Command	Description
<ESC>[7I	SSU (Size Select Unit)	Units can be pixels, decipoints, or centipoints. This example uses pixels.
<ESC>[99;2;2500;4200 {	DECSS (Set Sheet Size)	Defines manual feed input and the width (2500 pixels = 8 ½") and length (4200 pixels = 14") of the paper.
<ESC>[8J	PFS (Page Format Select)	Selects portrait mode of printing and sets the margins for the larger size paper.
<ESC>[99!v	DECASF (Automatic Sheet Feeder Control)	Selects the manual feed mode of operation.  <b>NOTE:</b> <i>Manual feed mode can also be selected from the FEEDER Menu, or from the control panel using Feeder Select.</i>

See Appendix A for additional programming information. For detailed information about sending commands from the host computer, consult the *Digital ANSI-Compliant Printing Protocol Level 3 Programming Reference Manual* and the *Digital ANSI-Compliant Printing Protocol Level 3 Programming Supplement*.

Section 2.9.1 describes how to feed media using Feeder Select on the control panel to invoke the manual feed mode. See Chapter 4 for information about setting the manual feed value from the FEEDER menu.

### 2.9.1 Manually Feeding Paper, Labels, and Transparencies

Use the following procedure to manually feed paper, labels, and transparencies. Refer to Chapter 5 for the specifications required for print media. Be sure the printer is set up to print on the media size you are using — either through the paper (size) feature in the INITIAL Menu, or by using commands from the host computer — before feeding media (see Section 2.9).

**NOTE:** *You can use the rear output tray or the top output tray when manually feeding paper. You must use the rear output tray when feeding labels or transparencies to prevent excessive curl.*

1. Set the printout selector to the faceup position.

MLO-005126 (Figure 2-20; 16 picas)



2. Fold out the extension tray.

MLO-005125 (Figure 2-21; 15.5 picas)

3. Press **On Line** to place the printer off line.
  - The On Line indicator shuts off.
4. Press **Feeder Select** until the display reads FEEDER = Manual.
  - After about three seconds the display will read 00 READY.
  - The manual feed mode selection is now stored in operating memory.
5. Press **On Line** to place the printer back on line.
  - The On Line indicator lights.
6. Send data from the host computer to the printer.
  - The Data indicator lights and the display reads PF FEED xxx (where xxx = paper size).

7. Adjust the manual feed guides to accept the width of the paper.

MLO-005132 (Figure 2-22; 15.5 picas)

8. Insert a single sheet of paper, labels, or a transparency into the printer until it stops.
  - The paper is automatically fed into the printer.
  - The printed paper is sent to the rear output tray.

**CAUTION:** *Remove transparencies from the rear output tray as each one is printed. This prevents them from sticking together.*

MLO-005133 (Figure 2-23; 15.5 picas)

9. Wait until PF FEED xxx is displayed and repeat step 8.
  - ✓ Continue feeding paper until the Data indicator light shuts off and the display reads 00 READY.
  - ✓ If you want to continue feeding paper manually after the display reads 00 READY, go to step 6. If you have finished feeding paper manually, go to step 10.
10. Press **On Line** to place the printer off line.
  - The On Line indicator shuts off.
11. Press **Feeder Select** until the paper feed mode you want to use is displayed (FEEDER = Lower, FEEDER = Upper, or FEEDER = Auto).
  - After about three seconds the display will read 00 READY.
  - The cassette feed mode selection is now stored in operating memory.
12. Press **On Line** to place the printer back on line.
  - The On Line indicator lights.

13. Set the printout selector to the duplex/facedown position.

MLO-005128 (Figure 2-24; 16 picas)

14. Fold in the extension tray.

MLO-005125 (Figure 2-25; 16 picas)

## 2.10 Feeding Envelopes Manually

Envelopes have the same setup requirements as all other media that are fed manually (see Section 2.9). Since you need to print addresses in a particular area on envelopes, you must give the printer the proper print coordinates to print the addresses. Normally the setup requirements for printing envelopes are defined by the application program you are using. Consult your application program documentation for details about its envelope printing feature.

If your application program does not have an envelope printing feature, you need to set up your address files using commands (escape sequences) that instruct the printer to print in the right location on the envelope. Section 2.9 contains an example of using escape sequences to print in a certain area on the page. Appendix A contains a listing of DEClaser 2200 printer commands and programming information for the experienced programmer. For detailed programming information to set up your address files, see the *Digital ANSI-Compliant Printing Protocol Level 3 Programming Reference Manual* and the *Digital ANSI-Compliant Printing Protocol Level 3 Programming Supplement*.

### 2.10.1 Feeding Envelopes

You should observe some special cautions before feeding envelopes into the printer. Make the following checks before you manually feed envelopes:

- The sealing flap should run along the length of the envelope, not at the leading or trailing edges.
- Be sure the sealing flap is folded properly with none of the glue exposed.
- The leading and trailing edges should not be more than two layers thick.
- The envelope should be folded without any wrinkles or creases.

Specifications for printing envelopes are listed in Section 5.2.

1. Set the printout selector to the faceup position.

MLO-005126 (Figure 2-26; 16 picas)

2. Fold out the extension tray.

MLO-005125 (Figure 2-27; 16 picas)

3. Press **On Line** to place the printer off line.
  - The On Line indicator shuts off.
4. Press **Feeder Select** until the display reads FEEDER = Manual.
  - After about three seconds the display will read 00 READY.
  - The manual feed mode selection is now stored in operating memory.
5. Press **On Line** to place the printer back on line.
  - The On Line indicator lights.
6. Send data from the host computer to the printer.
  - The Data indicator lights and the display reads PF FEED xxx (where xxx = paper size).
7. Adjust the manual feed guides to accept the width of the envelope.

MLO-005134 (Figure 2-28; 16 picas)



8. Insert a single envelope into the printer until the envelope stops.
  - The envelope is automatically fed into the printer.
  - The printed envelope is sent to the rear output tray.

MLO-005135 (Figure 2-29; 16 picas)

9. Wait until PF FEED xxx is displayed and insert another envelope.
  10. Continue feeding envelopes until the Data indicator light shuts off and the display reads 00 READY.
    - ✓ If you want to continue to manually feed envelopes after the display reads 00 READY, go to step 6. If you have finished feeding envelopes, go to step 11.
- NOTE:** *If the background of a printed envelope is fogged lightly with toner, you can reset the print density dial to a lower number to correct the fogging problem. See Section 2.11 for additional information about adjusting the print density dial.*
11. Press  to place the printer off line.
    - The On Line indicator shuts off.
  12. Press  until the feed mode you want is displayed (FEEDER = Lower, FEEDER = Upper, or FEEDER = Auto).
    - After about three seconds the display will read 00 READY.
    - The cassette feed mode selection is now stored in operating memory.
  13. Press  to place the printer back on line.
    - The On Line indicator lights.

14. Fold in the extension tray.

MLO-005124 (Figure 2-30; 16 picas)

15. Set the printout selector to the duplex/facedown position.

MLO-005128 (Figure 2-31; 16 picas)

## 2.11 Adjusting the Print Density

Print density is the term used to describe the relative thickness of the line used to print characters. The thickness of a line is known as the line weight. The print density adjustment controls the amount of toner applied to the paper to make the line weight thinner or thicker.

You can significantly extend the life of an Electrophotographic Supply (EP-S) cartridge by setting the print density adjustment dial to the highest possible number (lightest setting) that gives you acceptable print quality. For most applications a print density setting of 7 can be used to produce high-quality print, and extend the life of the cartridge.

**NOTE:** *The EP-S cartridge life can be up to 4,000 A4 or letter-size pages. This specification is based on 4% toner coverage with the print density set at 7.*

You can check the line weight thickness by printing the Engine Test Print after performing the adjustment (see Section 2.12).

Use the following procedure to adjust print density.

1. Press the release button forward and then down.
  - The top cover releases and opens slightly.

MLO-005118 (Figure 2-32; 15.5 picas)

2. Lift the top cover open to the halfway position.

MLO-004893 (Figure 2-33; 14.5 picas)

3. Rotate the print density adjustment dial so that the desired density number is opposite the index triangle.
  - ✓ Numbers on the dial are displayed in increments of 2.
  - ✓ Number 1 is the darkest setting; number 9 is the lightest setting.
  - ✓ Although the printer is shipped with the dial set to number 5, you can typically obtain acceptable print quality, prolong the cartridge life, and reduce toner consumption by setting the dial to 7.

MLO-004849 (Figure 2-34; 16 picas)

4. Close the top cover by gently lowering the cover and pushing down on the hand grip until the cover latches securely in place.

MLO-005120 (Figure 2-35; 16 picas)

## 2.12 Printing the Engine Test Print

The Engine Test Print (Figure 2–4) is used to check the printer's paper feed mechanism for proper operation, and to check toner dispersion and line weight.

The area between the lines on the Engine Test Print should be free of excess toner or smudges, and the lines should print cleanly across the entire page with no faded areas. If the print quality is poor, see Section 6.6 for help to correct the problem.

If the Engine Test Print will not print, there may be a problem with the paper feed mechanism. Refer to Section 6.6 for help to correct the problem. If you cannot correct the problem, call the Customer Services group to repair the printer (see Chapter 8 for service information).

You can check line weight by looking at the thickness of the line after performing a print density adjustment (Section 2.11).

**Figure 2-4: Engine Test Print**

MLO-004525 (Figure 2-36; 36 picas)



1. Check to be sure the printer has stopped printing and the message display reads 00 READY.
2. Press the test button on the right side of the printer with a ballpoint pen.
  - The printer enters the offline state.
  - The Alarm indicator lights while the page is printing.
  - The display reads 15 ENGINE TEST while the page is printing.
  - The printer remains in the offline state and the display reads 00 READY.

MLO-004894 (Figure 2-37; 19 picas)

3. Press  to place the printer back on line.

## **2.13 Printing Test Print A**

Test Print A (Figure 2-5) lists the current printer settings, along with information such as total page count and the amount of free memory available.

**Figure 2-5: Test Print A**

MLO-004895 (Figure 2-38; 36 picas)

When Test Print A can be printed, it is a nearly certain indication that the printer is functioning properly. You can print Test Print A to see what the current printer settings are before making changes in Menu Mode (see Chapter 4). Table 2–2 describes the items on Test Print A, and Table 2–3 describes how to print the test print.

**Table 2–2: Test Print A**

<b>Item</b>	<b>Description</b>
Version	This is the version of firmware the printer is using. The firmware version number aids the Customer Services engineer if there is a problem with the printer.
Total RAM	This is the total amount of random-access memory available in the printer. RAM is shown in kilobytes listing the base amount of RAM plus any optional RAM (base RAM + optional RAM).
Font Card	Lists the name of installed font cartridges and their location (left or right font cartridge slot).
Page Count	Indicates the total number of pages printed to date.
Free RAM	Indicates the total amount of RAM available. This memory space can be used to downline load fonts from the host computer, be reserved as bitmap pages, or used to support options such as PostScript.
Current Settings	Shows all of the setup menus and the current values in operational memory. Each menu also shows what kind of memory the values can be stored in: RAM only, NVRAM only, or in either type of memory (RAM + NVRAM).  See Table 4–7 and Section 4.5 for a complete listing and description of all the menu features.

Use the procedure in Table 2-3 to print a copy of Test Print A.

**Table 2-3: Printing Test Print A**

<b>Operation</b>	<b>Display Reads</b>
1. Press <b>On Line</b> to place the printer off line. — The On Line indicator shuts off.	00 READY
2. Press <b>Test/Font</b> once. — Test Print A prints.	05 TEST PRINT A ↓ 00 READY
3. Press <b>On Line</b> to place the printer back on line. — The On Line indicator lights.	00 READY

## **2.14 Printing Test Print B**

Test Print B (Figure 2–6) contains sample printouts of the primary and secondary character sets that can be examined for print quality.

**Figure 2-6: Test Print B**

MLO-004852 (Figure 2-39; 36 picas)

Test Print B is printed continuously (until instructed to stop) so it can also be used to test paper feed, paper delivery, and other mechanical functions of the printer.

Use the procedure in Table 2–4 to print a copy of Test Print B.

**Table 2–4: Printing Test Print B**

Operation	Display Reads
1. Press <b>On Line</b> to place the printer off line.  — The On Line indicator shuts off.	00 READY
2. Press and hold down <b>Test/Font</b> for about three seconds.  — The test page prints continuously.	01 TEST PRINT B
3. Press <b>Test/Font</b> to stop printing Test Print B.  <b>NOTE:</b> <i>You can also press <b>On Line</b> to stop printing Test Print B.</i>	04 TEST STOP ↓ 00 READY
4. Press <b>On Line</b> to place the printer back on line.  — The On Line indicator lights.	00 READY



## 2.15 Printing the Font List

Figure 2-7 shows the Font List, which contains a listing of all the available character sets in the printer, along with a sample of the available fonts.

**Figure 2-7: Font List**

MLO-004853 (Figure 2-40; 36 picas)

The Font List includes internal fonts, cartridge fonts, and fonts that have been downline loaded into memory. You can select fonts only by using commands from the host computer; you cannot select them from the control panel. For information about selecting fonts, refer to the *Digital ANSI-Compliant Printing Protocol Level 3 Programming Reference Manual* and the *Digital ANSI-Compliant Printing Protocol Level 3 Programming Supplement*.

Use the procedure in Table 2-5 to print the font list.

**Table 2-5: Printing the Font List**

Operation	Display Reads
1. Press <b>On Line</b> to place the printer off line. — The On Line indicator shuts off.	00 READY
2. Press <b>Test/Font</b> twice. — The font list prints.	06 FONT LIST ↓ 00 READY
3. Press <b>On Line</b> to place the printer back on line. — The On Line indicator lights.	00 READY

## 2.16 Using Control Representation Mode

The Control Representation Mode is used to print out unprocessed data or commands sent from the host computer. This procedure is sometimes referred to as “dumping.” The printing of unprocessed data (in the form of characters and symbols) is convenient for debugging programs. If a specified character is undefined, a hexadecimal representation is printed.

This section explains how to print the character listing. For additional information about Control Representation Mode, consult the *Digital ANSI-Compliant Printing Protocol Level 3 Programming Reference Manual*.

**NOTE:** *If the file does not fill the page buffer completely, the remaining data can be printed by pressing **On Line** to place the printer off line, and then pressing **Form Feed** to print the partial page.*

### 2.16.1 Entering Control Representation Mode

Use the procedure in Table 2–6 to place the printer in Control Representation Mode.

**Table 2–6: Entering Control Representation Mode**

Operation	Display Reads
1. Press <b>On Line</b> to place the printer off line.  — The On Line indicator shuts off.	00 READY
2. Press and hold <b>Reset</b> for about 10 seconds.	03 RESET ↓ 03 DUMP ↓ 03 RESET ↓ 00 READY    DUMP

The printer is now in Control Representation Mode and ready to accept data or commands from the printer. To exit Control Representation Mode, perform a soft reset (see Section 2.17).

## 2.17 Resetting the Printer

There are two methods of resetting the printer:

- You can perform a hard reset by powering the printer off and then back on.
- You can perform a soft reset by pressing **Reset**.

The primary reasons for a soft reset of the printer are to exit Control Representation Mode and to clear data in the page buffer.

Use the procedure in Table 2–7 to perform a soft reset.

**Table 2–7: Resetting the Printer**

<b>Operation</b>	<b>Display Reads</b>
1. Press <b>On Line</b> to place the printer off line.  — The On Line indicator shuts off.	00 READY
2. Press and hold <b>Reset</b> for about three seconds.	03 RESET ↓ 00 READY
3. Press <b>On Line</b> to place the printer back on line.  — The On Line indicator lights.	00 READY

## Chapter 3

# The Control Panel

---







The control panel consists of a liquid crystal display (LCD), indicator lights, and a keypad. The keypad allows you to perform certain printer functions such as printing test pages or configuring the printer menus. This chapter explains the features and uses of the control panel.

The layout of the control panel is shown in the following figure and described in Table 3-1.

### Figure 3-1: Control Panel

MLO-004896 (Figure 3-1; 11 picas)

**Table 3–1: Control Panel Functions**

Item	Function
Keypad	<p>Some keys on the keypad perform a dual function depending on whether the printer is in Keypad Mode or Menu Mode. In Keypad Mode, the keys perform the primary function labeled on the key such as Test/Font or Feeder Select. When the printer is in Menu Mode, the keys perform the secondary function labeled with the gray colored symbols and text, such as  or .</p> <p><b>NOTE:</b> All keys and related functions (with the exception of ) work only when the printer is off line. This is true whether the printer is in Keypad Mode or Menu Mode.</p> <p>See Section 3.1 for information about using the keypad in Keypad Mode.</p> <p>See Section 4.1 for information about using the keypad in Menu Mode.</p>
On Line indicator (green)	<p>Works in conjunction with  to indicate when the printer is on line or off line (see  in Table 3–2).</p> <p>On: The printer is on line and controlled by the host computer. The host computer can send data to print and commands to control the printer.</p> <p>Off: The printer is off line and cannot receive any data or commands from the host computer. It can only be controlled using the keys on the control panel.</p>
Form Feed indicator (green)	<p>Works in conjunction with  to indicate when data in the print buffer is being printed or when the command to print is canceled (see  in Table 3–2).</p> <p>On: Data in the print buffer is being printed.</p> <p>Off: Data is not being printed.</p> <p>Flashing: Command to print is canceled.</p>
Duplex indicator (green)	<p>Indicates whether the printer is set to print in duplex mode (two-sided printing) or simplex mode (one-sided printing).</p> <p>On: Prints in duplex mode.</p> <p>Off: Prints in simplex mode.</p>

**Table 3–1 (Cont.): Control Panel Functions**

<b>Item</b>	<b>Function</b>
Data indicator (green)	<p>Indicates the status of the data sent to the printer.</p> <p>On: Data is being printed or is still in the print buffer. If the indicator is on and the printer is not printing, it means the last page needs to be printed. Press <b>Form Feed</b> to print the last page.</p> <p>Off: All data has been printed.</p> <p>Flashing: Data is being received from the host computer.</p> <p><b>NOTE:</b> <i>Data is lost if you power off or reset the printer when the Data indicator is on or is flashing.</i></p>
Alarm indicator (orange)	<p>Indicates that an error condition exists. A “beep” sounds when the printer first senses an alarm condition. The message display works in conjunction with the Alarm indicator by showing the type of error condition.</p> <p>For example: 12 PRINTER OPEN</p> <p>The Alarm indicator shuts off when the error condition is cleared.</p> <p>See Chapter 6 for information on correcting printer errors.</p>
Ready indicator (green)	<p>Indicates when the printer is ready to print.</p> <p>On: The printer is ready to print.</p> <p>Off: The printer is powered off or an error condition exists (the Alarm indicator is on).</p> <p>Flashing: The printer is warming up.</p>
Message display	<p>The message display shows the current status of the printer.</p> <p>For example: 00 READY</p> <p>When the printer is in Menu Mode, the display shows the selected menu, feature, or value.</p> <p>For example: <u>C</u>OMMAND INITIAL</p>



**Table 3–1 (Cont.): Control Panel Functions**

Item	Function
Paper jam indicators (orange)	These indicators show the area where paper is jammed: in the upper paper path, the lower paper path, or in the rear output tray area. See Section 6.7 for information about clearing paper jams.
Paper feed indicators (green)	These light to indicate the currently selected paper feed cassette or envelope feeder. They are: <ul style="list-style-type: none"><li data-bbox="748 579 1052 606">• Envelope feeder (optional)</li><li data-bbox="748 627 1003 655">• Upper paper cassette</li><li data-bbox="748 676 1003 703">• Lower paper cassette</li></ul>

**NOTE:** *If none of the paper feed indicators are on, it indicates that the printer is in manual feed mode.*

### 3.1 Using the Keypad in Keypad Mode

Some keys on the keypad perform a dual function, depending on whether the printer is in Keypad Mode or Menu Mode. In Keypad Mode, the keys perform the primary function labeled on the key, such as Test/Font or Manual Feed. Table 3–2 shows the keypad functions in Keypad Mode.

**NOTE:** *With the exception of **On Line**, all keys operate only when the printer is off line. A “beep” sounds if any of these keys are pressed when the printer is on line.*

#### 3.1.1 Entering Keypad Mode

Enter Keypad Mode using the following procedure.

1. Press **On Line** to place the printer off line.
  - The On Line indicator shuts off.
  - The keypad is now in Keypad Mode.

**Table 3–2: Keypad Functions: Keypad Mode**

Key	Function
On Line	<p>Pressing <b>On Line</b> alternates the printer between the online mode and offline mode. The mode is indicated by the green light on the key.</p> <p>On: The printer is on line and controlled by the host computer. The host computer can send data to print and commands to control the printer.</p> <p>Off: The printer is off line and cannot receive any data or commands from the host computer. It can only be controlled using the keys on the control panel.</p>
Form Feed	<p><b>Form Feed</b> works in conjunction with the Data indicator. If the Data indicator is on after a file stops printing, it means there is still data in the print buffer. Pressing <b>Form Feed</b> prints the remaining pages in the print buffer.</p> <p>When you press <b>Form Feed</b>, the indicator on the key lights to show that the data is being printed. If you press <b>Form Feed</b> again while the data is printing, it stops printing the remaining pages and the indicator flashes until the current page exits the printer. Once the page exits the printer, the indicator light remains off. <b>Form Feed</b> can be pressed again to resume printing.</p>
Error Skip	<p>The DEClaser 2200 printer alerts you to certain error conditions by stopping the printer and displaying the type of error on the control panel. When this happens you may elect to note the problem and then continue printing by pressing <b>Error Skip</b>. Pressing <b>Error Skip</b> bypasses these errors so that printing continues. After you press <b>Error Skip</b> the printer remains off line. You must press <b>On Line</b> to place the printer back on line and continue printing.</p> <p>Some errors can repeat, such as communications errors or print formatting errors when the printer is receiving additional communication data. When this happens you may need to repeat the Error Skip procedure several times. Refer to Chapter 6 for additional information about errors and corrective actions.</p>

**Table 3–2 (Cont.): Keypad Functions: Keypad Mode**

<b>Key</b>	<b>Function</b>
<b>Test/Font</b>	<p><b>Test/Font</b> performs several functions in Keypad Mode:</p> <ul style="list-style-type: none"><li>• Pressing the key once prints Test Print A (see Section 2.13).</li><li>• Pressing and holding the key down for at least three seconds prints Test Print B (see Section 2.14).</li><li>• Pressing the key twice prints the Font List (see Section 2.15).</li></ul>
<b>Reset</b>	<p>Pressing <b>Reset</b> performs a soft reset by clearing the data in the print buffer and returning the printer to the ready state. The printer operates with the settings currently stored in RAM, which are loaded into operating memory when a reset is performed.</p> <p>You can also use <b>Reset</b> to exit Control Representation Mode (see Section 2.16).</p>
<b>Menu</b>	<p>Places the printer in Menu Mode and displays the first menu: <b>FONT/FEED LAYOUT</b>.</p> <p>Refer to Section 4.1 for more information about Menu Mode.</p>
<b>Duplex</b>	<p>Pressing <b>Duplex</b> alternates between simplex mode (one-sided printing) and duplex mode (two-sided printing). If the printer “beeps” when you press <b>Duplex</b>, check to be sure that the printout selector is in the duplex position (see Table 1–2), and that the printer is not set in the manual feed mode of operation (see Section 4.5.1).</p>

**Table 3–2 (Cont.): Keypad Functions: Keypad Mode**

Key	Function
Feeder Select	<p data-bbox="667 369 1243 422">Pressing <b>Feeder Select</b> changes the paper feed selection. There are five paper feed modes:</p> <ul data-bbox="667 443 1243 684" style="list-style-type: none"><li data-bbox="667 443 1243 470">• Auto feed (either upper or lower cassette)</li><li data-bbox="667 491 1243 518">• Upper cassette</li><li data-bbox="667 539 1243 567">• Lower cassette</li><li data-bbox="667 588 1243 615">• Manual feed</li><li data-bbox="667 636 1243 684">• Option (available only when the optional envelope feeder is installed)</li></ul> <p data-bbox="667 705 1243 779">See Section 4.5.1 for additional information about the feeder selections. See Section 2.9 for more information about feeding print media manually.</p> <p data-bbox="667 800 1243 842"><b>NOTE:</b> <i>The manual feed and option feed modes are not selectable when the printer is in duplex mode.</i></p>

## 3.2 Using the Keypad in Menu Mode

You configure the printer by selecting certain parameters (features and values) while in Menu Mode. You select these parameters using keypad keys that function differently when the printer is in Menu Mode. Chapter 4 covers printer configuration and explains the use of the keypad when in Menu Mode (see Section 4.1).

## Chapter 4

# Printer Configuration

---

This chapter describes how to configure the printer by selecting operating parameters that can be stored in the printer's memory. These operating parameters are known as features and values. By selecting the correct operating parameters, you ensure that the printer can communicate properly with the host computer and application software.

You configure the DEClaser 2200 printer by selecting an appropriate set of values from a group of printer setup menus. You make these selections while the printer is in Menu Mode. Once values are selected you can save them in the appropriate type of memory. Saving features in the proper type of memory allows you to retain most printer values so that the printer has to be configured only once. Figure 4-1 shows a sample menu from Test Print A.

**Figure 4-1: Sample of a Menu**

MLO-004856 (Figure 4-1; 11.5 picas)

You can access some menu features by using commands from the host computer; you can select others only from the control panel. This chapter describes how to select features using the control panel. For information about selecting features using commands from the host computer, see the *Digital ANSI-Compliant Printing Protocol Level 3 Programming Reference Manual* and the *Digital ANSI-Compliant Printing Protocol Level 3 Programming Supplement*.

**NOTE:** *The interface, message, and page offset features can be configured only from the control panel.*

## 4.1 Entering Menu Mode

You configure the printer by selecting certain parameters (features and values) while in Menu Mode. When the printer is in Menu Mode, the keys labeled with gray text and symbols function to select parameters from the menu. Table 4–1 shows how to enter Menu Mode.

**NOTE:** *With the exception of On Line, all keys operate only when the printer is off line.*





**Table 4–1: Entering Menu Mode**

Operation	Display Reads
1. Press <span style="border: 1px solid black; padding: 0 2px;">On Line</span> to place the printer off line.  — The On Line indicator shuts off.	00 READY
2. Press <span style="border: 1px solid black; padding: 0 2px;">Menu</span> to place the printer in Menu Mode.  — The printer is now in Menu Mode and the keys labeled with gray text and symbols operate.	<u>F</u> ONT/ <u>F</u> EED LAYOUT

### 4.1.1 Using the Keypad in Menu Mode

Table 4–2 describes the function of the Menu Mode keys. After reading the description of the Menu Mode keys, you may want to try using the keys to better understand their functionality. See Section 4.4.1 for an example that uses the Menu Mode keys to configure the printer.

**Table 4–2: Keypad Functions: Menu Mode**

Key	Function
	Performs two functions: <ul style="list-style-type: none"><li>• Scrolls the menus and features to the right</li><li>• Increases numeric values</li></ul>
	Performs two functions: <ul style="list-style-type: none"><li>• Scrolls the menus and features to the left</li><li>• Decreases numeric values</li></ul>
	Returns the printer to the previous level of operation
	Performs three functions: <ul style="list-style-type: none"><li>• Advances to the next (lower) menu level</li><li>• Invokes the ROM, RAM, and NVRAM functions</li><li>• Invokes the selected value</li></ul>
	Exits Menu Mode and returns printer operation back on line

## 4.2 Reading the Display in Menu Mode

Printer status and operator call messages are shown on the display in uppercase lettering, preceded by a numerical code. Examples of such messages are 00 READY or 11 PAPER OUT. Menu Mode messages are displayed differently to distinguish differences between the menu selections, feature selections, and value selections.

**NOTE:** *The menu names on the message display are written to accommodate the protocols available on the DEClaser 2200 printer (ANSI, PostScript, or CaPSL). Depending on the protocol being used, the menu names that appear on the message display may not read exactly as they do on Test Print A. For example, if you are using Digital's ANSI-Compliant Printing Protocol, the first menu listed on Test Print A is the FEEDER menu, but on the message display it is printed as the FONT/FEED menu.*

### 4.2.1 Displaying Menu and Feature Selections

Menu and feature selections are scrolled to the left or right, and are shown on the display in groups of 16 characters. This means that in addition to the menu or feature you have selected, other characters are displayed from the next menu or feature. Think of the menu and feature selections as being placed on a scrolling band separated only by a space. The display shows a group of 16 characters from the band and denotes the selection by displaying it first with a cursor below the first letter. See the examples in Figure 4-2.

Figure 4-2: Menu Display

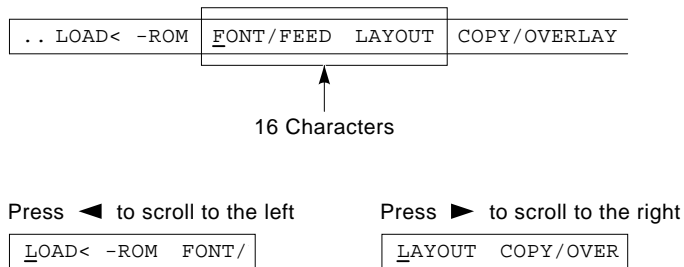

MLO-004919



This manual shows items from the scrolling menus and features as they are displayed (uppercase, lowercase, or initial capitals) with the selected item shown in bold type for clarification. For example:

**FONT FEED LAYOUT** or **offsetX offsetY**

### 4.2.2 Displaying Menu Values

Menu values are scrolled to the right and left using  and  and are displayed with the associated feature, for example:

i/f    **RS232C**

When you scroll through the values, the currently selected value is always displayed first and is denoted by an equal sign (=) between the feature and value, for example:

i/f    =**RS232C**

## 4.3 Printer Configuration Memory

Printer configuration uses four types of memory: an operating memory that contains the currently selected values, and three storage memories in which values are stored or saved. These memories are known as ROM (read-only memory), RAM (random-access memory), and NVRAM (nonvolatile random-access memory).

**NOTE:** *All four types of printer configuration memory are separate and distinct from the Free RAM listed on Test Print A. Configuration memory can be accessed only from the menus to set up the operational parameters of the printer.*

You can save new values temporarily in RAM, but they are cleared when the printer is powered off. You can also save new values in NVRAM so that they are not cleared if the printer is reset or powered off. ROM contains the factory default values that can be recalled into the operating memory. Some values can be saved only in RAM or only in NVRAM, while other values can be saved in either type of memory. For a listing of the types of memory in which values can be saved, see Table 4–7.

### 4.3.1 Operating Memory

The printer operates using the currently selected values contained in operating memory. When the printer is powered on, it loads the values stored in NVRAM into operating memory. When you select new values (through escape sequences or from the control panel), they are placed in operating memory and become part of the printer settings that are currently in use. Figure 4-3 shows the operational flow between the different types of memory.

**Figure 4-3: Operating Memory**

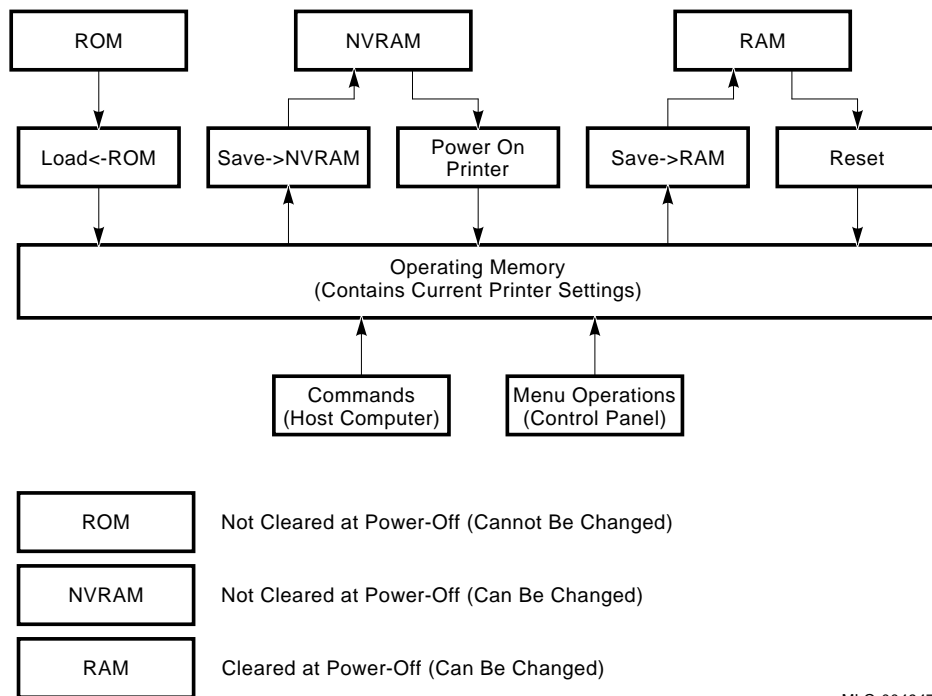

MLO-004947

### 4.3.2 ROM (Read-Only Memory)

Read-only memory contains default values that are set at the factory. They are called default values because they are stored in ROM and cannot be changed. You can load these default values into operating memory while in Menu Mode using the procedure shown in Table 4–3.

**NOTE:** *Default values loaded from ROM are temporary values, and are affected if the printer receives a reset command or is powered off. If you want to retain the default values, you must save them in NVRAM (see Section 4.3.3).*

**Table 4–3: Recalling Factory Default Values from ROM**

Operation	Display Reads
1. Press <b>On Line</b> to place the printer off line. — The On Line indicator shuts off.	00 READY
2. Press <b>Menu</b> to place the printer in Menu Mode.	<b>FONT/FEED LAYOUT</b>
3. Press <b>Left Arrow</b> once.	<b>LOAD&lt;-ROM FONT/F</b>
4. Press <b>Enter</b> to load the default values from ROM.	OK (momentarily) ↓ <b>LOAD&lt;-ROM FONT/F</b>
5. Press <b>On Line</b> to place the printer on line. — The On Line indicator lights.	00 READY

### 4.3.3 NVRAM (Nonvolatile Random-Access Memory)

The printer can communicate with many systems using the factory default settings in ROM, but you may have to change values to accommodate your particular application or host computer. NVRAM allows those changes to be saved in a nonvolatile memory so that they are available each time you power on the printer. In nonvolatile memory the selected values are not cleared when the printer is powered off or reset. Selections are saved in NVRAM until you change them. To save values in NVRAM while in Menu Mode, use the procedure shown in Table 4-4.

**Table 4-4: Saving Values in NVRAM**

<b>Operation</b>	<b>Display Reads</b>
1. Press <b>On Line</b> to place the printer off line. — The On Line indicator shuts off.	00 READY
2. Press <b>Menu</b> to place the printer in Menu Mode.	<b>FONT/FEED LAYOUT</b>
3. Press <b>&lt;</b> twice.	<b>SAVE-&gt;NVRAM LOAD</b>
4. Press <b>Enter</b> to save the values in NVRAM.	OK (momentarily) ↓ <b>SAVE-&gt;NVRAM LOAD</b>
5. Press <b>On Line</b> to place the printer on line. — The On Line indicator lights.	00 READY

### 4.3.4 RAM (Random-Access Memory)

Random-access memory is a temporary memory area that stores selected values until the printer is powered off. It is useful to store features in RAM when you need to change settings for specific print jobs. To save values in RAM while in Menu Mode, use the procedure in Table 4–5.

**Table 4–5: Saving Values in RAM**

<b>Operation</b>	<b>Display Reads</b>
1. Press <b>[On Line]</b> to place the printer off line.  — The On Line indicator shuts off.	00 READY
2. Press <b>[Menu]</b> to place the printer in Menu Mode.	<b>FONT/FEED LAYOUT</b> _
3. Press <b>[&lt;]</b> three times.	<b>SAVE-&gt;RAM SAVE-&gt;</b> _
4. Press <b>[V Enter]</b> to save the values in RAM.	OK (momentarily) ↓ <b>SAVE-&gt;RAM SAVE-&gt;</b> _
5. Press <b>[On Line]</b> to place the printer on line.  — The On Line indicator lights.	00 READY

## 4.4 Operational Flow in Menu Mode

Figure 4–4 illustrates the operational flow to select and change values while in Menu Mode. See Section 4.4.1 for an example of selecting values while in Menu Mode.

Figure 4-4: Operational Flow Chart

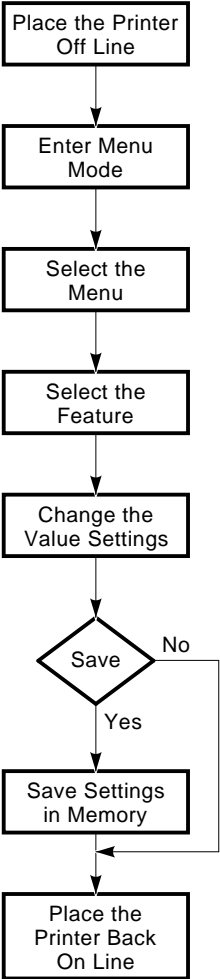

MLO-004946

### 4.4.1 Sample Procedure for Changing and Saving Values

This section contains an example of how to change and save values in Menu Mode. Use the steps in Table 4–6 to perform the following tasks:

- Enter Menu Mode
- Change page offset values of X and Y in the LAYOUT menu from +0.0 to –10.0
- Save the new values in NVRAM
- Exit Menu Mode

#### Before You Begin

This example assumes that the printer is using the factory default values in ROM. You will use Test Print A to verify the changes you make. Print a copy of Test Print A before beginning this example (Section 2.13). Be sure that all printing has stopped and the display reads 00 READY before you make any changes.

**Table 4–6: Changing and Saving Values**

<b>Operation</b>	<b>Display Reads</b>
1. Press <b>On Line</b> to place the printer off line.  — The On Line indicator shuts off.	00 READY
2. Press <b>Menu</b> to place the printer in Menu Mode.	<b>FONT/FEED LAYOUT</b>
3. Press <b>▢</b> once to scroll the display to the LAYOUT menu.	<b>LAYOUT COPY/OVER</b>
4. Press <b>▽ Enter</b> to enter the LAYOUT menu.	<b>offsetX offsetY</b>
5. Press <b>▽ Enter</b> to select the offsetX feature.	offsetX =+ <b>0.0</b>

**Table 4–6 (Cont.): Changing and Saving Values**

<b>Operation</b>	<b>Display Reads</b>
6. Press <b>◀</b> until the value equals -10.0.  <i>NOTE: The value decreases in steps of 0.5.</i>	offsetX <u>-</u> 10.0
7. Press <b>▽ Enter</b> to enter the new value.	offsetX =-10.0 (momentarily) ↓ <u>offsetX</u> offsetY
8. Press <b>▶</b> once to scroll the display to the offsetY feature.	<u>offsetY</u> autoNL o
9. Press <b>▽ Enter</b> to select the offsetY feature.	offsetY =+0.0
10. Press <b>◀</b> until the value equals -10.0.  <i>NOTE: The value decreases in steps of 0.5.</i>	offsetX <u>-</u> 10.0
11. Press <b>▽ Enter</b> to enter the new value.	offsetY =-10.0 (momentarily) ↓ <u>offsetY</u> autoNL o
12. Press <b>△</b> to return to the menu selections.	<u>LAYOUT</u> COPY/OVER
13. Press <b>◀</b> three times to reach the NVRAM SAVE menu.	<u>SAVE-&gt;</u> NVRAM LOAD
14. Press <b>▽ Enter</b> to save the offset values in NVRAM.	OK (momentarily) ↓ <u>SAVE-&gt;</u> NVRAM LOAD



**Table 4–6 (Cont.): Changing and Saving Values**

Operation	Display Reads
15. Press <span style="border: 1px solid black; padding: 0 2px;">On Line</span> to exit Menu Mode.	00 READY
— The On Line indicator lights.	

**Verification**

To verify that the offset distances have been changed, print a copy of Test Print A and compare it with the copy made before the changes. Verify the changes by comparing the new layout of the page and the offset values in the LAYOUT menu (see Figure 4–5).

**Figure 4–5: Test Print A Verification**

MLO-004897 (Figure 4-5; 36 picas)

## 4.5 Menu Descriptions

This section describes the printer menus, features, and values. See Table 4–7 for a complete listing of all menus and parameters.

**Table 4–7: Menu Mode Features and Values**

Menu	Features	Values
FEEDER	feeder	Upper <sup>1</sup> Auto Manual Lower Option <sup>4</sup>
LAYOUT	offsetX <sup>2</sup>	-10.0
		.
		.
		+0.0 <sup>1</sup>
		.
	offsetY <sup>2</sup>	+10.0
		-10.0
		.
		+0.0 <sup>1</sup>
		.
autoNL	ON <sup>1</sup>	
	OFF	
COPY	copy	01 <sup>1</sup> –99

<sup>1</sup>Factory default setting.

<sup>2</sup>Cannot be selected using a command from the host. Selectable from the control panel only.

<sup>4</sup>Available only when the optional envelope feeder is installed.

**Table 4–7 (Cont.): Menu Mode Features and Values**

<b>Menu</b>	<b>Features</b>	<b>Values</b>
COMMAND	message <sup>2</sup>	English <sup>1</sup> Finnish French German Italian Japan Norway Port. Spanish Swedish Danish Dutch
INITIAL	macro	000 <sup>1</sup> –099
	paint	Partial <sup>1</sup> Full Dual
	paper	Letter <sup>1</sup> A4
INTERFACE	<i>i/f</i> <sup>2</sup>	RS232C <sup>1</sup> CENTRO
	baud <sup>3</sup>	300 600 1200 2400 4800 <sup>1</sup> 9600 19200
	rsmode <sup>3</sup>	8S <sup>1</sup> 8SS 7OS 7ES 7OSS 7ESS 8OS 8ES
	dtr <sup>3</sup>	Fix-H <sup>1</sup> Ready-H

<sup>1</sup>Factory default setting.

<sup>2</sup>Cannot be selected using a command from the host. Selectable from the control panel only.

<sup>3</sup>Available only when RS232C is selected.

**Table 4–7 (Cont.): Menu Mode Features and Values**

<b>Menu</b>	<b>Features</b>	<b>Values</b>
	xon/xoff <sup>3</sup>	ON <sup>1</sup> OFF
	etx/ack <sup>3</sup>	OFF <sup>1</sup> ON
DUPLEX	duplex	OFF <sup>1</sup> ON

<sup>1</sup>Factory default setting.

<sup>3</sup>Available only when RS232C is selected.

### 4.5.1 FEEDER Menu

The FEEDER menu determines whether paper is fed manually or automatically from one of the cassettes. The optional envelope feeder can also be selected from the FEEDER menu when that option is installed. The paper feed selection is shown on the control panel by the paper feed indicators. The lighted indicator shows the selected feed cassette or envelope feeder. If none of the indicators are on, it indicates that the manual feed mode of operation is selected. For more information about manual feed operation, see Section 2.9.

The FEEDER menu values can also be selected using  on the control panel. See Table 3–2 for more information about using .

Table 4–8 shows the features and values of the FEEDER menu.

**NOTE:** *Two envelope options are available for the DEClaser 2200: an envelope “cassette” and an envelope “feeder.” The envelope feeder shares the upper slot with the paper cassette, while the envelope cassette must be installed in the upper slot. Keep this distinction in mind when selecting the proper value from the FEEDER menu.*

**Table 4–8: FEEDER Menu Features and Values**

<b>Feature</b>	<b>Values</b>	<b>Description</b>
feeder	Upper <sup>1</sup>	Selects the upper paper cassette to automatically feed paper into the printer.  <b>NOTE:</b> <i>You must select the Upper value when using the optional envelope “cassette” because the envelope cassette can only be installed in the upper cassette slot of the printer.</i>
	Auto	Feeds from one of the cassettes until it runs out of paper, and then automatically switches over to the second cassette to continue printing. You can load paper into the empty cassette while printing from the second cassette. This feature allows you to print continuously for larger printing jobs. The same size paper cassettes must be used when printing in the Auto feed mode.
	Manual	Selects the manual feed mode of operation. You must feed paper one sheet at a time when in the manual feed mode.  <b>NOTE:</b> <i>The Manual value cannot be selected if the printer is in duplex mode.</i>
	Lower	Selects the lower paper cassette to automatically feed paper into the printer.
	Option <sup>2</sup>	Selects the optional envelope “feeder” to automatically feed envelopes into the printer.

<sup>1</sup>Factory default setting.

<sup>2</sup>Available only when the optional envelope feeder is installed.

## 4.5.2 LAYOUT Menu

The features of the LAYOUT menu shown in Table 4–9 allow you to make adjustments to the print position (the distances from the edges of the paper where printing begins) and to set the new line so that print wraps when it reaches the right margin.

**Table 4–9: LAYOUT Menu Features and Values**

Feature	Values	Description
offsetX	-10.0	Determines the offset distance from the right and left sides of the page. An offset of 10.0 is approximately 1.1".
	.	
	.	
	+0.0 <sup>1</sup>	
	.	
	+10.0	
offsetY	-10.0	Determines the offset distance from the top and bottom of the page. An offset of 10.0 is approximately 1.1".
	.	
	.	
	+0.0 <sup>1</sup>	
	.	
	+10.0	
autoNL	ON <sup>1</sup>	When the print position reaches the right margin, it wraps to the left margin of the next line.
	OFF	When the print position reaches the right margin, it does not move to the next line until the printer receives a carriage return (CR) or line feed (LF) command from the host computer. Data beyond the right margin is lost until the carriage return or line feed command is received.

---

<sup>1</sup>Factory default setting.

---



#### 4.5.2.1 Offset Position (offsetX, offsetY)

The offset feature of the LAYOUT menu allows you to make fine adjustments to the printing coordinates. Since the DEClaser 2200 printer is a page printer, it is not possible to adjust the print position by manually shifting the position of the page. Do not use offset to move normal data to different positions on the page. It should only be used as a mechanism to center the print on the page. Test Print B is typically used when adjusting the offset positions.

You cannot set offset positions using escape sequences from the host computer. You must select them from the control panel.

Figure 4-6 shows the directions of offsetX and offsetY in relation to the direction that paper is fed into the printer.

**NOTE:** *Offset values are changed in increments and decrements of approximately 0.1" from the default value of +0.0". For example, an offset value of +5.0 moves the print origin approximately 0.5".*

**Figure 4-6: Offset Positioning**

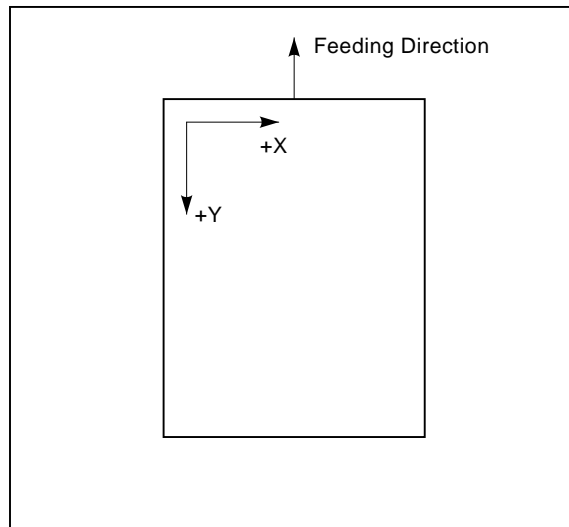

MLO-004944

Figure 4-7 shows sample printouts of Test Print B that use different offset values.

**Figure 4-7: Offset Printout Samples**

MLO-004898 (Figure 4-7; 22 picas)

#### 4.5.2.2 Automatic New Line (autoNL)

The autoNL feature determines whether or not the printer wraps to the next line when it reaches the right margin.

#### 4.5.3 COPY Menu

The COPY menu (Table 4–10) determines the number of copies to be printed. You can save this setting only in RAM.

**Table 4–10: COPY Menu Features and Values**

Feature	Values	Description
copy	01 <sup>1</sup> –99	Sets the number of copies to be printed.

<sup>1</sup>Factory default setting.

#### 4.5.4 COMMAND Menu

The COMMAND menu (Table 4–11) is used to display messages on the control panel in your native language. Three types of messages are displayed in the desired language: status, operator call, and error messages. Service call messages and menus are displayed only in English.

You cannot select this setting using escape sequences from the host computer. You must select it from the control panel. You can save the setting only in NVRAM.

**Table 4–11: COMMAND Menu Features and Values**

Feature	Values	Description
message	English <sup>1</sup> Finnish French German Italian Japan (Japanese) Norway (Norwegian) Port. (Portuguese) Spanish Swedish Danish Dutch	Displays messages in the selected language.

<sup>1</sup>Factory default setting.

### 4.5.5 INITIAL Menu

The INITIAL menu (Table 4–12) combines the macro, paint, and paper size features. You can save settings from this menu only in NVRAM.

**Table 4–12: INITIAL Menu Features and Values**

Feature	Values	Description
macro	000 <sup>1</sup> –099	Assigns the user preference set and device identification answer (see Section 4.5.5.1).
paint	Partial <sup>1</sup>	None of the memory is reserved for bitmap pages. Memory is allocated dynamically.
	Full	Directs the printer to allocate memory space for one full bitmap page (A4 or letter-size). The Full setting eliminates complex errors but may slow the printer down if all pages require a full bitmap.  <b>NOTE:</b> <i>This value can be activated only if at least 1 MB of optional RAM is installed in the printer.</i>
	Dual	Directs the printer to allocate memory space for two full bitmap pages (A4 or letter-size). The Dual setting allows you to print at a more efficient speed for documents that require full page bitmaps for all pages. It also allows you to print duplex pages, for which each side requires a full page bitmap. The Dual setting requires more memory space that must be shared with fonts.  <b>NOTE:</b> <i>This value can be activated only if at least 2 MB of optional RAM is installed in the printer.</i>
paper	Letter <sup>1</sup>	Specifies letter-size (8 ½" x 11.0") paper for manual feed operation.
	A4	Specifies A4-size (297 mm x 210 mm) paper for manual feed operation.

---

<sup>1</sup>Factory default setting.

---

#### 4.5.5.1 Macro

The macro feature allows you to select an environment for local compatibility. It specifies the return response (device identification) when a Device Attributes (DA) request is received, and assigns the proper User Preference character set. The macro feature is slightly different from other menu features because two parameters (device ID and user preference character set) are *added together* to determine the macro value. The device ID and user preference values cannot be selected independently, they must be added together to form the macro value.

The DEClaser 2200 printer can identify itself as a Digital ANSI-Compliant Printing Protocol level 3 printer, and therefore can be recognized as such by symbionts and terminal drivers that conform to Digital ANSI-compliant architecture. This identification is also compatible with level 2 devices because all level 2 sequences are also supported. You can also select an LN03 identification for applications that require the printer to identify itself as an LN03 printer. For example, the DECmate word processing system requires an LN03 device identification. The device identification values are shown in Table 4–13.

**Table 4–13: Device Identification**

Device ID	Value
Digital ANSI-compliant level 3 device	00 <sup>1</sup>
LN03	10

<sup>1</sup>Factory default setting.

The second parameter of the macro feature allows you to choose the User Preference character set appropriate for your application or system. Consult the *Digital ANSI-Compliant Printing Protocol Level 3 Programming Reference Manual* for more information about the user preference sets. Table 4–14 lists the User Preference character sets and their values.

**Table 4–14: User Preference Character Set**

---

<b>User Preference Character Set</b>	<b>Value</b>
DEC Supplemental	0 <sup>1</sup>
ISO Latin-1 Supplemental	1
JIS Katakana	2
ISO Latin-Hebrew Supplemental	3
DEC Latin-Hebrew Supplemental	4
DEC 7-Bit Hebrew	5
DEC Technical	6

---

<sup>1</sup>Factory default setting.

---

#### 4.5.5.2 Examples Using the Macro Feature

The examples in Table 4–15 demonstrate how to determine the macro value.

**Table 4–15: Macro Feature Examples**

<b>Character Set and Value</b>	<b>Device ID and Value</b>	<b>Macro Value Total</b>
JIS Katakana (2)	Level 3 (00)	02
DEC Technical (6)	Level 3 (00)	06
DEC Supplemental (0)	LN03 (10)	10

#### 4.5.5.3 Paint Mode (paint)

The paint mode (paint) feature instructs the printer to reserve memory space for one or two full bitmap pages, or not to allocate any bitmapped memory space for page printing. Since printer memory is shared with both fonts and page drawings, it is usually desirable to let the printer allocate the memory dynamically, because even full page sixel images often print in partial paint mode. You should enable the printer to direct the memory allocation mechanism only in the following situations:

- If you are receiving error messages about page complexity, for example, 21 COMPLEX DATA.
- If pages are breaking incorrectly, for example, half the page prints on one sheet and the second half on the next sheet.

See Table 4–12 for a complete description of the paint mode values.

#### 4.5.5.4 Paper Size (paper)

The paper size (paper) feature determines the printable area on the page. It is only used in manual feed mode when no other command (escape sequence) has been received to specify paper size. See Section 2.9 for additional information about manually feeding media.

## 4.5.6 INTERFACE Menu

The correct interface connection is necessary for the printer to communicate properly with the host computer. The DEClaser 2200 printer supports both parallel and serial interface connections. The interface must match the type used by the host computer.

You cannot make selections from the INTERFACE menu using commands from the host computer. All values must be selected from the control panel and can be saved only in NVRAM. Once you make the selections you should save them in NVRAM so that they will be activated (loaded into operational memory) each time the printer is powered on. The INTERFACE menu features and values are shown in Table 4–16.

**Table 4–16: INTERFACE Menu Features and Values**

Feature	Values	Description
i/f	RS232C <sup>1</sup>	Selects the serial interface to communicate with the host computer. Select this value if your computer uses a serial interface.  When RS232C is selected you must select values for all the other features in this menu (baud rate, rsmode, and so on).
	CENTRO	Selects the (CENTRONICS) parallel interface to communicate with the host computer. Select this value if your printer uses a parallel interface. When the parallel interface is selected, all other features in the interface menu are ignored.
baud <sup>2</sup>	300	Sets the transmit and receive speed the printer uses to communicate with the host computer. The printer speed must match the speed used by the host computer.
	600	
	1200	
	2400	
	4800 <sup>1</sup>	
	9600	
rsmode <sup>2</sup>	19200	
	8S <sup>1</sup>	8 data bits No parity check 1 stop bit
	8ES	8 data bits Even parity check 1 stop bit

<sup>1</sup>Factory default setting.

<sup>2</sup>Available only when RS232C is selected.



**Table 4–16 (Cont.): INTERFACE Menu Features and Values**

<b>Feature</b>	<b>Values</b>	<b>Description</b>
	8OS	8 data bits Odd parity check 1 stop bit
	7ESS	7 data bits Even parity check 2 stop bits
	7OSS	7 data bits Odd parity check 2 stop bits
	7ES	7 data bits Even parity check 1 stop bit
	7OS	7 data bits Odd parity check 1 stop bit
	8SS	8 data bits No parity check 2 stop bits
dtr <sup>2</sup>	Fix-H <sup>1</sup>	Sets the DTR line to a fixed high signal.
	Ready-H	Sets the DTR line to a high signal when the printer is ready to receive data.
xon/xoff <sup>2</sup>	ON <sup>1</sup>	Enables buffer overflow control.
	OFF	Disables buffer overflow control.
etx/ack <sup>2</sup>	OFF <sup>1</sup>	Disables buffer overflow control.
	ON	Enables buffer overflow control.
<b>NOTE:</b> <i>EtX/ack is not supported on Digital systems.</i>		

---

<sup>1</sup>Factory default setting.

<sup>2</sup>Available only when RS232C is selected.

---

#### **4.5.6.1 Interface Selection (i/f)**

The interface selection (i/f) feature selects the type of interface used to communicate with the host computer. It must match the interface used by the host computer, either serial or parallel.

When you select the parallel interface, you do not select any other settings in the INTERFACE menu. The other features in this menu apply only

to the serial interface and are not displayed when you select the parallel interface.

When you select the serial interface, you must also select certain other values in the INTERFACE menu in order to match the features of the host computer. The additional features are described next.

#### **4.5.6.2 Baud Rate (baud)**

The baud rate (baud) feature sets the transmit and receive speed the printer uses to communicate with the host computer. The printer speed must match the speed used by the host computer.

#### **4.5.6.3 RS232C Data Format (rsmode)**

The RS232C data format (rsmode) feature determines the data format the printer uses to communicate with the host computer. The first part of the value (7 or 8) is the number of data bits the printer expects to see in each character it receives. The second part of the value is the type of parity (checking) bit the printer looks for in each character. A parity check is a method used to detect errors when data is sent over a communications line. Some systems use an odd parity bit to detect errors, while other systems use an even parity bit. Some systems use no parity bit at all. The third part of rsmode is the number of stop bits. Some systems use one stop bit, while other systems require two. The format for the data bits, parity bit, and stop bits must match the format of the host computer in order for the printer and the host to communicate.

#### **4.5.6.4 Data Terminal Ready (dtr)**

The data terminal ready (dtr) feature uses hardware to regulate the flow of data to the input buffer of the printer. Regulation is accomplished by toggling a signal on the DTR line of the serial port when the printer is ready to receive data. This is sometimes referred to as hardware handshaking protocol.

For Digital systems, the dtr feature should always be set to the fixed high value. When the DTR signal is fixed high (Fix-H) it indicates to the system that the printer is "present."

#### **4.5.6.5 Buffer Control (xon/xoff)**

The buffer control (xon/xoff) feature uses software to regulate the flow of data to the input buffer of the printer. It is sometimes referred to as software handshaking protocol, a method the printer and the host computer use to exchange on/off signals. These signals prevent the input buffer from overflowing with data. If the input buffer becomes full and handshaking is not enabled, the overflowing data will be lost. Xon/xoff must be enabled in systems that use this software handshaking protocol to prevent the loss of data.

#### 4.5.6.6 End of Text/Acknowledge (etx/ack)

The end of text/acknowledge (etx/ack) feature is used with another type of handshaking protocol on some systems to prevent data overflow. The etx/ack feature also uses software to regulate the flow of data to the input buffer by exchanging signals with the host computer. It is recommended that this feature be enabled by systems that support etx/ack to prevent the loss of data.

**NOTE:** *The etx/ack feature is not supported on Digital systems. Use xon/xoff if you have a Digital system.*

#### 4.5.7 DUPLEX Menu

The DUPLEX menu determines whether paper is printed on one or two sides. The duplex printing mode can be selected under software control from the host, or by using  Duplex on the control panel. Duplex mode is indicated when the Duplex indicator is on. See Table 3–2 for more information about using  Duplex.

**NOTE:** *Duplex mode cannot be selected if the printer is in the manual feed mode of operation, or if the printout selector is set to the faceup position.*

Table 4–17 shows the features and values of the DUPLEX menu.

**Table 4–17: DUPLEX Menu Features and Values**

Feature	Values	Description
duplex	OFF <sup>1</sup>	Selects the simplex mode of operation. Paper is printed on one side in simplex mode.
	ON	Selects the duplex mode of operation. Paper is printed on two sides in duplex mode and delivered to the top output tray.

<sup>1</sup>Factory default setting.

## Chapter 5

# Print Media

---

This chapter describes the print media that are appropriate for use with the DEClaser 2200 printer. The types of print media described in this chapter are paper, labels, transparencies, and envelopes.

The DEClaser 2200 printer produces excellent print quality using electrophotographic laser technology. The laser printing process differs greatly from that of a conventional impact printer, and this is why paper selection is particularly important. Because toner is bonded to the paper as it passes through the heat and pressure rollers of the fixing unit, the paper must be able to withstand high amounts of heat and pressure.

**CAUTION:** *When selecting paper or other print media, always print test samples of the paper you want to use. This is particularly important when you are printing on chemically treated or coated paper, such as preprinted forms or colored paper. The inks and pigments used on these papers must also be able to withstand the high heat and pressure of the fixing unit. Be sure to consider the heat limitations of transparencies and the glues used on envelopes and labels. Always select print media according to the instructions and specifications in this chapter. For a complete listing of recommended print media and ordering information, see Appendix B.*

Print quality can also deteriorate if paper is not stored properly. Read Section 5.5 in this chapter for complete information about storing paper.

For additional information about print media, consult the *Digital Laser Printers Guide to Paper and Other Media* available from DECdirect (see the ordering information at the end of this guide).

## 5.1 Paper Specifications

This section contains information on the sizes and specifications of plain paper that can be used with the DEClaser 2200 printer.

Table 5–1 lists the paper sizes that can be used with the standard and optional size cassettes for the printer.

**Table 5–1: Cassette Feed Paper Sizes**

<b>Paper Size</b>	<b>Dimensions</b>
A4	210 mm x 297 mm
Executive	7 ¼" x 10 ½"
Letter	8 ½" x 11"
Legal	8 ½" x 14"

### **Manual Feed Paper and Envelope Sizes**

Manual feed operation can accept all of the paper sizes listed in Table 5–1 as well as the following sizes for paper and envelopes:

Minimum: 100 mm x 190 mm (4" x 7 ½")

Maximum: 216 mm x 356 mm (8 ½" x 14")

Table 5–2 lists paper specifications for the DEClaser 2200 printer.

**Table 5–2: Paper Specifications**

<b>Category</b>	<b>Specification</b>
Paper weight: cassette feed	60 g/m <sup>2</sup> to 80 g/m <sup>2</sup> basis weight (16 lb. to 21 lb.)
Paper weight: manual feed	60 g/m <sup>2</sup> to 135 g/m <sup>2</sup> basis weight (16 lb. to 35 lb.)
Thickness	0.075 mm to 0.115 mm
Moisture content	5% to 8%
Smoothness	100–300 Sheffield
Brightness	84% minimum recommended
Heat tolerance	200°C (392°F) for 0.1 second
Electrical resistance	1.0 x 10 <sup>11</sup> ohm-cm–2.0 x 10 <sup>12</sup> ohm-cm (cubic content) 2.0 x 10 <sup>10</sup> ohm-cm–2.0 x 10 <sup>11</sup> ohm-cm (surface)
Cotton (rag) content	25% maximum

### 5.1.1 Special Considerations When Printing on Paper

Because of the way laser printers print and bond toner to the paper, you must observe some special requirements with certain types of papers.

- Do not use preprinted papers that do not meet the specifications for heat tolerance. The ink from some preprinted papers, such as those with a company letterhead, can cause smearing and in some extreme cases could damage the printer.
- Do not use colored papers in which the color is applied as a coating to the surface.
- Do not use thermal papers.
- Prepunched paper is not recommended.
- Do not use carbon papers.

## 5.2 Envelope Requirements

Envelopes must meet the same specifications as paper (see Table 5–2). In addition, the following types of envelopes cannot be used with the printer:

- Envelopes with sealing flaps that are open

MLO-004859 (Figure 5-1; 14.5 picas)

- Envelopes with sealing flaps at the leading and trailing edges

MLO-004860 (Figure 5-2; 14.5 picas)

- Envelopes with three or more layers of paper at the leading and trailing edges

MLO-004861 (Figure 5-3; 15 picas)



- Envelopes that have transparent windows

MLO-004862 (Figure 5-4; 14 picas)

- Envelopes that have clasps, snaps, or strings

MLO-004863 (Figure 5-5; 14.5 picas)

## 5.2.1 Special Considerations When Printing on Envelopes

Observe the following requirements when printing on envelopes:

- Feed envelopes manually (if you are not using the special envelope cassette or envelope feeder).
- The optional envelope feeder cannot be used in the Auto feed mode.
- Envelopes can be printed only on the front side.
- Since you need to print addresses in a particular area on envelopes, you must give the printer the proper print coordinates to print the addresses. See Section 2.10 for more information about printing on envelopes.
- You cannot print in the 15 mm (3/5") border around the envelope.
- Use the rear output tray (printout selector set for faceup print).
- Install the optional envelope cassette only into the upper cassette slot.

MLO-004864 (Figure 5-6; 10 picas)

## 5.3 Transparencies

Table 5–3 and Table 5–4 contain information on the sizes and specifications of transparencies that can be used with the DEClaser 2200 printer.

**Table 5–3: Transparency Sizes**

Transparency Size	Dimensions
A4	210 mm x 297 mm
Letter	8 ½" x 11"

**Table 5–4: Transparency Specifications**

Category	Specification
Transparency weight	60 g/m <sup>2</sup> to 135 g/m <sup>2</sup> basis weight (16 lb. to 36 lb.)
Thickness	0.075 mm to 0.115 mm
Moisture content	5% to 8%
Smoothness	100–300 Sheffield
Heat tolerance	200°C (392°F) for 0.1 second
Electrical resistance	1.0 x 10 <sup>11</sup> ohm-cm–2.0 x 10 <sup>12</sup> ohm-cm (cubic content) 2.0 x 10 <sup>10</sup> ohm-cm–2.0 x 10 <sup>11</sup> ohm-cm (surface)

### 5.3.1 Special Considerations When Printing Transparencies

Observe the following requirements when printing on transparencies:

- Transparencies are usually fed manually. If you are feeding transparencies from a cassette, be sure they are high-quality transparencies and meet the specifications listed in Table 5–4.
- Remove transparencies from the rear output tray as each one is printed to prevent them from sticking to each other.

## 5.4 Labels

A label consists of a face sheet, an adhesive sheet, and a carrier sheet. The face sheet (or printing surface) is usually composed of photocopying paper and should meet the same specifications for paper as described in Table 5-2. The carrier sheet and adhesive used for the labels must also be able to meet the heat tolerance specification of 200°C (392°F) for at least 0.1 second.

**CAUTION:** *Do not expose the adhesive on the labels because it could cause damage to the printer. An easy way to test for adhesive that may be exposed is to press a plain piece of paper on top of the sheet of labels. If the paper sticks to the labels, you should not use those labels.*

Figure 5-1 shows the types of labels that are unacceptable.

### Figure 5-1: Unacceptable Labels

MLO-004527 (Figure 5-7; 15.5 picas)

### **5.4.1 Special Considerations When Printing on Labels**

Observe the following requirements when printing on labels:

- Labels are usually fed manually. If you are feeding labels from a cassette, be sure they are high-quality labels that meet the specifications listed in Table 5-2.
- Be sure that the carrier sheet is not exposed.
- Be sure that no adhesive is exposed.
- Use the rear output tray.

## 5.5 Paper Handling and Storage

Although you may be using paper that meets all specifications, improper handling and storage may affect the quality of the paper and the performance of the printer. Improper storage and handling can cause paper jams, misfeeding, and other printer performance problems.

Follow the recommendations in this section on paper storage and handling to reduce the possibility of printer jams and misfeeds.

### 5.5.1 Paper Handling

Observe the following requirements when handling paper:

- Load the cassette to its proper capacity rather than adding small amounts at a time. Loading small amounts of paper can cause jams because of air pockets created between small stacks of paper.
- When you unwrap a new package of paper, discard the top and bottom sheets, as they tend to absorb the most humidity from the surrounding environment.
- Check to see that the paper is loaded with the correct side up. Some packages of paper have an arrow on the label that points in the direction of the top side of the paper. Load paper with this top side up.

If there is no arrow on the label, check the paper for curl. If a small amount of curl is present, fan the paper in the opposite direction of the curl to remove as much of the curl as possible.

- Follow the instructions in Chapter 2 to properly load paper.

### 5.5.2 Paper Storage

Observe the following requirements when storing paper:

- Always store unused paper in its original wrapping. The wrapping protects the paper against humidity.
- Do not store paper directly on the floor, as floors are generally humid.
- Lay paper on a flat surface to prevent in-ream paper curl.

## Chapter 6

# Troubleshooting

---

This chapter helps you to quickly locate most problems that may occur with the printer. It discusses the following topics:

- Error skip procedure
- Printer status messages
- Operator call messages
- Software error messages
- Service call messages
- Common operating problems
- Paper jams

Most problems are identified on the message display when they occur. The corrective action to take is listed in the appropriate table as follows:

- Printer Status Messages, Table 6-1
- Operator Call Messages, Table 6-2
- Software Error Messages, Table 6-3
- Service Call Messages, Table 6-4
- Common Operating Problems, Table 6-5

Note that the printer status messages do not require operator intervention.

### 6.1 Error Skip Procedure

The DEClaser 2200 printer alerts you to error conditions by stopping the printer, placing it off line, and displaying the type of error on the control panel. Some error conditions need to be corrected immediately before printing can continue, for example, 12 PRINTER OPEN. You can acknowledge other types of errors and still continue printing by using the Error Skip key. When these type of errors occur you may elect to take the long-term corrective action (for example, adding RAM or reassigning memory) at another time.

Use the following procedure to acknowledge the error condition and continue printing:

1. Press **Error Skip**.
  - The Alarm indicator shuts off.
  - The error condition clears.
  - The display reads 00 READY.
2. Press **On Line**.
  - The On Line indicator lights.
  - Printing continues.

Some communication or formatting errors may repeat when the printer is receiving additional communications data. When this happens you may need to repeat the error skip procedure several times.

## 6.2 Printer Status Messages

Printer status messages are displayed to show the printer's current operating condition (see Table 6–1). This status information lets you know if the printer is performing a task or is ready to receive another job. Status messages are displayed whether the printer is on line or off line.

**Table 6–1: Printer Status Messages**

<b>Message</b>	<b>Meaning</b>
00 READY	The printer is ready to operate. The ready condition can exist whether the printer is on line or off line.
01 TEST PRINT B	Test Print B is being printed (Section 2.14).
02 WARMING UP	The printer has not reached operating temperature. Printing cannot be performed while the printer is warming up.
03 RESET	The printer is being reset (Section 2.17).
04 TEST STOP	Test printing has stopped.
05 TEST PRINT A	Test Print A is being printed (Section 2.13).
06 FONT LIST A	Font List A is being printed (Section 2.15).
15 ENGINE TEST	The mechanical engine test is being executed (Section 2.12).



## 6.3 Operator Call Messages

Operator call messages appear if a problem with the printer requires operator intervention, such as adding paper or closing the printer cover. You should check the online/offline status of the printer after correcting a problem; you may have to place the printer back on line by pressing [On Line](#). Table 6–2 lists the operator call messages.

**NOTE:** *The operator call message number flashes when it is displayed.*

**Table 6–2: Operator Call Messages**

Message	Meaning	Corrective Action
11 PAPER OUT	There is no paper in the paper cassette.	Add paper to the paper cassette (Section 2.8.1).
	There is no paper cassette installed in the printer, or the cassette is not installed securely.	Install the paper cassette securely into the printer.
12 PRINTER OPEN	The top cover of the printer is open.	Close the top cover (Section 2.4).
13 PAPER JAM	Paper is jammed inside the printer.	Remove jammed paper from the printer (Section 6.7).
14 NO EP-CART.	There is no EP-S cartridge in the printer.	Install an EP-S cartridge in the printer (Section 7.3).
16 TONER LOW	Toner in the EP-S cartridge is not being distributed evenly.	Remove the cartridge and rotate it back and forth several times to re-distribute toner evenly (Section 7.3).
	The EP-S cartridge has run out of toner.	Replace the EP-S cartridge (Section 7.3).
17 U<->L FEED	There is no paper in the upper or lower paper cassette.	Add paper to the empty paper cassette (Section 2.8.1).
	The upper or lower paper cassette is not installed in the printer, or the cassette is not installed securely.	Install the paper cassette securely into the printer.
	The paper cassettes are not the same size.	The upper and lower paper cassettes must be the same size when the printer is in auto feeding mode.

**Table 6–2 (Cont.): Operator Call Messages**

<b>Message</b>	<b>Meaning</b>	<b>Corrective Action</b>
18 EC INCORRECT	The optional envelope cassette is incorrectly installed in the lower cassette slot.	The optional envelope cassette can be used only from the upper cassette slot. Install the envelope cassette into the upper cassette slot.
	Duplex mode is incorrectly specified when the envelope cassette is installed.	See Section 6.6.1 to correct this error condition.
19 PAPER PATH 3	Duplex mode is incorrectly specified to feed envelopes from the optional envelope feeder.	See Section 6.6.1 to correct this error condition.
19 PAPER PATH 4	The printout selector is placed in the faceup position.	Return the printout selector to the duplex/facedown position (Section 2.5).
PC LOAD A4	Load A4-size paper.	Install an A4-size paper cassette into the printer.
PC LOAD LETTER	Load letter-size paper.	Install a letter-size paper cassette into the printer.
PC LOAD LEGAL	Load legal-size paper.	Install a legal-size paper cassette into the printer.
PC LOAD EXEC	Load executive-size paper.	Install an executive-size paper cassette into the printer.
PF FEED A4	Feed A4-size paper.	Manually feed A4-size paper into the printer.
PF FEED LETTER	Feed letter-size paper.	Manually feed letter-size paper into the printer.
PF FEED LEGAL	Feed legal-size paper.	Manually feed legal-size paper into the printer.
PF FEED EXEC	Feed executive-size paper.	Manually feed executive-size paper into the printer.
PF FEED PAPER 80	Feed specified-size paper.	Manually feed the specified-size paper into the printer. The number “80” indicates that the paper size is specified from a software command in the file.

## 6.4 Software Error Messages

Many software errors can be corrected by adding additional memory, reassigning memory, or by selecting the proper interface parameter. Table 6–3 describes the corrective action to take when a software error occurs.

**Table 6–3: Software Error Messages**

<b>Message</b>	<b>Meaning</b>	<b>Corrective Action</b>
20 PAGE FULL	The page buffer is overflowing with data.	Clear fonts from memory after each job.  Assign one or two full-page bitmap areas in memory to handle the complex data (see Section 4.5.5.3).  Add additional RAM.
21 COMPLEX DATA	There is complicated print data that the printer cannot handle.	Assign one or two full-page bitmap areas in memory to handle the complex data (see Section 4.5.5.3).
22 LINE ERROR	The receiving buffer is overflowing with data.	Enable a handshaking protocol to regulate data flow (see Section 4.5.6.4, Section 4.5.6.5, and Section 4.5.6.6).  Ensure that the host, the printer, and any other devices that are connected (such as print servers) all have the same type of handshaking protocol enabled.
23 MEMORY FULL	Memory cannot accept additional downline loading of fonts into memory.	Clear fonts from memory after each job.  Reallocate less bitmap page memory space (Section 4.5.5.3).  Add additional RAM.
24 FULLPAINT REJ	Full paint mode is not allowed due to lack of memory space.	Clear fonts from memory after each job.  Add additional RAM.
26 MEMORY FULL	RAM space is full.	Clear fonts from memory after each job.  Add additional RAM.

**Table 6–3 (Cont.): Software Error Messages**

<b>Message</b>	<b>Meaning</b>	<b>Corrective Action</b>
40 LINE ERROR	An error has occurred in the communication circuit.	Check the interface parameters (Section 4.5.6).  Check the integrity of lines; be sure cables are properly shielded and that all ground screws are in place.
41 PRINT CHECK	A misprint has occurred.	Perform the error skip procedure (Section 6.1).
42 ERROR	There is an expansion interface error.	Power off the printer and verify that any memory expansion boards are correctly installed. If the problem continues, call Customer Services (Chapter 8).
43 ERROR	There is an expansion interface error.	Power off the printer and verify that any memory expansion boards are correctly installed. If the problem continues, call Customer Services (Chapter 8).
FE FONT REMOVAL	A font cartridge has been removed from the printer.	Power off the printer and install the font cartridge before powering the printer back on.  If you do not want to use the font cartridge, power off the printer and wait at least two seconds, then power it back on.
FF FONT FULL	The font registration area is full.	Reduce the number of fonts in memory.  Clear fonts from memory after each job.

## 6.5 Service Call Messages

Service call messages indicate that the printer requires servicing by a qualified Digital Customer Services engineer. Service messages are preceded by the numbers 50 through 99.

**Table 6–4: Service Call Messages**

Message	Meaning	Corrective Action
XX SERVICE (where XX equals a number from 50–99)	Service is required to correct the problem.	Call Digital for service (Chapter 8).

## 6.6 Common Operating Problems

Table 6–5 lists common operating problems and their possible solutions. All solutions are listed in order of probability, and you should follow the solutions in order. Check the table to solve printer problems before calling for service.

**NOTE:** *Since many problems with print quality could be caused by a faulty component in the EP-S cartridge, it is recommended that you keep a spare cartridge as a replacement. If you are experiencing a problem with print quality that is not listed in the troubleshooting table, you can replace the EP-S cartridge to see if that solves the problem before calling for service.*

**CAUTION:** *Be careful when checking items inside the printer, because the fixing assembly may be hot.*

**Table 6–5: Common Operating Problems**

<b>Problem</b>	<b>Possible Cause</b>	<b>Corrective Action</b>
<b>NO POWER</b>		
The printer does not power up when you set the power switch to the ON position.	The power source is defective.	Make sure the power cord is plugged into the wall outlet. Check that there is power at the wall outlet by plugging in a lamp to see if it lights. If the lamp does not light, call your building maintenance services to check the circuit supplying power to that outlet.
	The power cord is not connected or is damaged.	Check the power cord for damage and secure connections at the printer and at the wall outlet.
<b>NO PRINTOUT</b>		
The message display reads 00 READY.	The interface cable to the host is not connected properly.	Check the cable connections at the printer and at the host computer.
	Interface selection, baud rate, or data bits/parity features may not match the host settings.	See Section 4.5.6 for information about these features.
	The printer is in the offline state.	Press <b>On Line</b> to place the printer on line.
The message display reads 00 READY and the Data indicator is on.	Data is still in the print buffer.	Press <b>On Line</b> to place the printer off line and then press <b>Form Feed</b> to print the remaining data. Be sure to press <b>On Line</b> to place the printer back on line after the last page is printed.

**Table 6–5 (Cont.): Common Operating Problems**

<b>Problem</b>	<b>Possible Cause</b>	<b>Corrective Action</b>
<b>POOR PRINTING</b>		
Large amounts of vertical fade and/or white streaks are on the page.	Toner is not being dispersed evenly.	Remove the EP-S cartridge from the printer and gently rock it several times to redistribute toner (see Section 7.3).  Replace the EP-S cartridge (Section 7.3).
Small amounts of fading occur across the page.	The transfer corona wire is dirty.	Clean the transfer corona wire (Section 7.1.3).
Vertical black streaks occur on the page.	The primary corona wire is dirty.	Clean the primary corona wire (Section 7.1.2).
Printing is too light.	The print density setting is incorrect.	Adjust the print density setting (Section 2.11).
	The primary and transfer corona wires are dirty.	Clean the primary and transfer corona wires (Section 7.1.2 and Section 7.1.3).
	The primary corona wire is faulty.	Replace the EP-S cartridge (Section 7.3).
	The transfer corona wire is faulty.	Call Digital Customer Services to repair the printer (Chapter 8).
Printing is too dark.	The print density setting is incorrect.	Adjust the print density setting (Section 2.11).
The page printed blank.	The toner seal was not completely removed from the EP-S cartridge.	Remove the toner seal completely from the EP-S cartridge.
	The EP-S cartridge is faulty.	Replace the EP-S cartridge (Section 7.3).
The page printed black.	The primary corona wire is broken or is not making contact.	Be sure the EP-S cartridge is seated properly in the printer.
		Replace the EP-S cartridge (Section 7.3).
Stray toner is fused to the paper.	The printer is dirty.	Clean the printer (Section 7.1).

**Table 6–5 (Cont.): Common Operating Problems**

<b>Problem</b>	<b>Possible Cause</b>	<b>Corrective Action</b>
<b>POOR PRINTING</b>		
	The cleaning mechanism in the EP-S cartridge is not working properly.	Replace the EP-S cartridge (Section 7.3.)
The overall print quality is poor.	The print medium is not the recommended type.	See Chapter 5 for print media specifications.
<b>MISCELLANEOUS</b>		
Print lines overlap.	The vertical pitch setting is incorrect.	Correct the vertical pitch setting in your application program.
The print is skewed.	The print medium is not the recommended type.	See Chapter 5 for print media specifications.
	Paper is not loaded in the cassette properly.	Reload paper in the cassette (Section 2.8.1).
Printed pages have garbled characters.	Incorrect printer features were selected.	Check to see that the baud rate and data bits/parity format match the host computer settings (Section 4.5.6).
Envelopes are fogged lightly with toner.	Print density setting is too light.	Increase the print density setting by selecting a lower number on the print density dial (Section 2.11).
Printer “beeps” when <b>Duplex</b> is pressed.	The printout selector is not set to the duplex position.	Set the printout selector to the duplex position (Section 2.5).
	The printer is in manual feed mode.	Set the FEEDER menu value to Auto, Upper, or Lower (Section 4.5.1).



### 6.6.1 Incorrect Printing Mode

An incorrect printing mode error occurs when the duplex mode of operation is incorrectly selected to print envelopes. Select the simplex mode of operation as follows:

1. Press  to place the printer off line.
  - The On Line indicator shuts off.
2. Press  to select the simplex mode of operation.
  - The Duplex indicator shuts off.
3. Set the printout selector to the faceup print position.
4. Fold out the extension tray.

MLO-004900 (Figure 6-1; 16 picas)

5. Press  to place the printer back on line.
  - The On Line indicator lights.

## 6.7 Paper Jams

The following actions occur when there is a paper jam in the printer:

- The printer stops printing and goes off line.
- The error message 13 PAPER JAM is displayed on the control panel.
- The Alarm indicator lights.
- The paper jam indicator lights.

Most paper jams occur in the areas shown in Figure 6-1.

### Figure 6-1: Paper Jam Areas

MLO-004529 (Figure 6-2; 23 picas)

After you clear a paper jam, you must reset the printer by closing the top cover. Closing the cover clears the error condition and automatically resets the printer. After the cover is closed, press  to place the printer back

on line. When a paper jam is cleared and printing is resumed, the printer automatically reprints the page that jammed.

### **6.7.1 Paper Jam Areas 1, 6, and 7**

Use the following procedure to clear paper jams from the top or rear paper trays. This procedure illustrates a jam in the top tray. You use the same method to clear a paper jam from the rear tray.

**CAUTION:** *Do not attempt to remove jammed paper from the top or rear paper trays by simply pulling the paper out. Pulling the paper from the printer without releasing it from the fixing assembly first can cause damage to the printer.*

1. Open the top cover by pressing the release button forward and then down.
  - The top cover releases and opens slightly.

MLO-005342 (Figure 6-3; 15.5 picas)

2. Lift the top cover open.

MLO-004531 (Figure 6-4; 13.5 picas)

3. Push the tab on the fixing assembly back to release the paper.

**WARNING:** *Be careful when accessing areas inside the printer, because the fixing assembly may be hot.*

MLO-004866 (Figure 6-5; 16 picas)

4. Remove the jammed paper from the printer by pulling it out from the paper tray.

MLO-004530 (Figure 6-6; 16 picas)

5. Close the top cover by gently lowering the cover and pushing down on the hand grip until the cover latches securely in place.
  - The printer initializes (recycles).
  - The Alarm and Data indicators shut off.
  - The message display reads 00 READY.

MLO-005120 (Figure 6-7; 16 picas)

6. Press  to place the printer on line.
  - The printer reprints the page that was jammed.

### **6.7.2 Paper Jam Areas 2, 3, 4, and 6**

Use the following procedure to clear paper jams from the paper feed, transfer, and fixing assembly areas.

1. Open the top cover by pressing the release button forward and then down.
  - The top cover releases and opens slightly.

MLO-005118 (Figure 6-8; 15.5 picas)

2. Lift the top cover open.

**WARNING:** *Be careful when accessing areas inside the printer, because the fixing assembly may be hot.*

MLO-004531 (Figure 6-9; 13.5 picas)



3. If paper is jammed in the feed or transfer area, lift the transfer guide (green handle) to release the paper and remove the paper from the printer.

- ✓ If the jammed paper did not reach the feed area, remove the cassette and pull the paper out from the cassette slot.

MLO-005340 (Figure 6-10; 16 picas)

4. If paper is jammed in the fixing assembly, push the green tab on the fixing assembly down to release the paper, and remove the paper from the printer.

**WARNING:** *Be careful when accessing areas inside the printer, because the fixing assembly may be hot.*

MLO-004870 (Figure 6-11; 16 picas)

5. Close the top cover by gently lowering the cover and pushing down on the hand grip until the cover latches securely in place.
  - The printer initializes (recycles).
  - The Alarm and Data indicators shut off.
  - The message display reads 00 READY.

MLO-005120 (Figure 6-12; 16 picas)

6. Press  to place the printer on line.
  - The printer reprints the page that was jammed.

### **6.7.3 Paper Jam Area 5 (Duplex Printing Mode Only)**

Use the following procedure to clear paper jams from the lower paper path area.

1. Open the top cover by pressing the release button forward and then down.
  - The top cover releases and opens slightly.

MLO-005118 (Figure 6-13; 15.5 picas)

2. If paper is jammed in the transfer area, lift the transfer guide (green handle) to release the paper.

MLO-005340 (Figure 6-14; 16 picas)

3. Open the side door and lift the green paper jam lever to raise the paper path plate.
  - The side door is spring-loaded and remains open when you lift the green paper jam lever.

MLO-004535 (Figure 6-15; 16 picas)

4. Remove the jammed paper from the lower paper path area.

MLO-004534 (Figure 6-16; 15.5 picas)

5. Lower the green paper jam lever to its operating position.
  - The side door is spring loaded and automatically closes when the paper jam lever is lowered into its operating position.

MLO-004533 (Figure 6-17; 15.5 picas)

6. Close the top cover by gently lowering the cover and pushing down on the hand grip until the cover latches securely in place.
  - The printer initializes (recycles).
  - The Alarm and Data indicators shut off.
  - The message display reads 00 READY.

MLO-005120 (Figure 6-18; 16 picas)

7. Press  to place the printer on line.
  - The printer reprints the page that was jammed.

#### **6.7.4 Paper Jam Area 8 (Duplex Printing Only)**

Use the following procedure to clear paper jams from the paper reversing area on the rear output tray.

1. Lift and hold the paper jam lever to remove jammed paper from the paper reversing area.

MLO-004532 (Figure 6-19; 16 picas)

2. Open and then close the top cover to clear the error condition.



## Chapter 7

# Maintenance

---

To obtain optimum performance from the DEClaser 2200 printer, you must perform the prescribed care and maintenance as outlined in this chapter. This chapter describes how to properly maintain the printer and covers the following topics:

- Cleaning the printer
- Cleaning the primary corona wire
- Cleaning the transfer corona wire
- Extending EP-S cartridge life
- Replacing the EP-S cartridge
- Replacing the ozone filter

### 7.1 Cleaning the Printer

Keeping the printer clean helps ensure optimum print quality, because stray paper dust and toner can adversely affect the voltage levels placed on the corona wires, paper, and electrophotostatic drum. Although cleaning is part of the procedure you follow when replacing the EP-S cartridge, you may find it necessary to clean the printer between cartridge changes if print quality begins to deteriorate.

**CAUTION:** *To prevent possible damage to the internal and external surfaces of the printer, do not use cleaners or solvents. Use a clean cloth dampened with water only.*

### **7.1.1 Cleaning the Internal Surfaces**

Clean the transfer and paper feed areas inside the printer using the following procedure.

1. Be sure the printer is not printing and the display reads 00 READY.
2. Press the power switch on the back of the printer to the O (OFF) position.

MLO-005117 (Figure 7-1; 15 picas)

3. Press the release button forward and then down.
  - The top cover releases and opens slightly.

MLO-005118 (Figure 7-2; 15.5 picas)

4. Lift the top cover open.

MLO-004531 (Figure 7-3; 13.5 picas)

5. Wipe the paper feed area (black plastic) clean with a cloth dampened with water.

**WARNING:** *Be careful when accessing areas inside the printer, because the fixing assembly may be hot.*

MLO-004871 (Figure 7-4; 16 picas)

6. Wipe the following items clean in the transfer area with the dampened cloth:
  - The movable transfer guide (with green handle) and clear plastic strip
  - The metal transfer roller
  - The silver-colored metal transfer guide

MLO-004872 (Figure 7-5; 16 picas)

7. Gently close the top cover by pushing down on the hand grip until the cover latches securely into place.

MLO-005120 (Figure 7-6; 16 picas)

### **7.1.2 Cleaning the Primary Corona Wire**

The primary corona wire is located inside the EP-S cartridge. A dirty primary corona wire can cause black streaking to occur on the paper, and should be cleaned to correct this problem.

1. Be sure the printer is not printing and the display reads 00 READY.
2. Press the power switch on the back of the printer to the O (OFF) position.

MLO-005117 (Figure 7-7; 15 picas)

3. Press the release button forward and then down.
  - The top cover releases and opens slightly.

MLO-005118 (Figure 7-8; 15.5 picas)

4. Open the top cover halfway.

MLO-004893 (Figure 7-9; 14.5 picas)



5. Remove the EP-S cartridge by pulling it out from the top cover.

MLO-004890 (Figure 7-10; 18 picas)

6. Remove the wire/pin cleaner from the inside of the printer.

**WARNING:** *Be careful when removing the wire/pin cleaner from the printer, because the fixing assembly may be hot.*

MLO-004873 (Figure 7-11; 16 picas)

7. Insert the felt end of the wire/pin cleaner into either end of the EP-S cartridge slot.

**CAUTION:** *Do not insert the brush end of the wire/pin cleaner into the slot. Inserting the brush end can damage the corona wire.*

MLO-004875 (Figure 7-12; 15.5 picas)

8. Move the cleaner in the slot from side to side three to four times to clean the corona wire.

MLO-004874 (Figure 7-13; 14 picas)

9. Return the wire/pin cleaner to its storage location in the printer.

MLO-004873 (Figure 7-14; 16 picas)

10. Install the EP-S cartridge into the top cover.

MLO-004363 (Figure 7-15; 18 picas)

11. Gently close the top cover by pushing down on the hand grip until the cover latches securely into place.

MLO-005120 (Figure 7-16; 16 picas)

### 7.1.3 Cleaning the Transfer Corona Wires and Discharging Pins

The transfer corona wires and discharging pins are part of the paper transfer area inside the printer. Normally, you clean these corona wires and discharging pins each time you replace the EP-S cartridge, but you may find it necessary to clean them between cartridge replacements if you experience problems with print quality.

**NOTE:** *Use a dry cotton swab, such as the one supplied with new EP-S cartridges, to clean the corona wires.*

1. Be sure the printer is not printing and the display reads 00 READY.
2. Press the power switch on the back of the printer to the O (OFF) position.

MLO-005117 (Figure 7-17; 15 picas)

3. Press the release button forward and then down.
  - The top cover releases and opens slightly.

MLO-005118 (Figure 7-18; 15.5 picas)

4. Lift the top cover open.

MLO-004531 (Figure 7-19; 13.5 picas)

5. Remove the wire/pin cleaner from the inside of the printer.

**WARNING:** *Be careful when removing the wire/pin cleaner from the printer, because the fixing assembly may be hot.*

MLO-004873 (Figure 7-20; 16 picas)



6. Clean the discharging pins (in the groove) using the brush end of the cleaner.

**CAUTION:** *You must lift the brush over the separation wires as you clean along the groove. Be careful not to break the wires as you clean the discharging pins.*

MLO-004876 (Figure 7-21; 20 picas)

7. Return the wire/pin cleaner to its storage location in the printer.

MLO-004873 (Figure 7-22; 16 picas)

8. Clean the transfer corona wire and the nylon separation wires with the cotton swab.

**CAUTION:** *The corona wire and nylon separation wires are fragile. Do not press down too hard on the wires.*

MLO-004877 (Figure 7-23; 14.5 picas)

9. Gently close the top cover by pushing down on the hand grip until the cover latches securely into place.

MLO-005120 (Figure 7-24; 16 picas)

## 7.2 Extending EP-S Cartridge Life

Each EP-S cartridge contains a photosensitive drum and toner, assuring you of optimum print quality throughout the life of the cartridge. When the cartridge runs out of toner, you replace it with a new one.

**CAUTION:** *The use of refilled EP-S cartridges is not recommended and may adversely affect print quality. Consumables available through Digital, or recommended by Digital, should be used with Digital laser printers.*

A new EP-S cartridge lasts for approximately 4,000 pages (A4 or letter-size) of typical word processing text at 4% coverage with the print density dial set to 7. However, the cartridge life will vary depending on the amount of toner used for your particular application and the print density setting. If your average page contains more “white space” than the typical 4% coverage, the cartridge life will be longer. You can significantly extend the life of an EP-S cartridge by setting the print density adjustment dial to the highest number possible (lightest setting) that gives you acceptable print quality. The higher setting reduces the amount of toner used. For most applications the dial can be set to 7. See Section 2.11 for information about setting the print density.

The following rules apply to cartridge care:

- For best print quality always use the EP-S cartridge before the expiration date printed on the box.
- Do not remove the cartridge from its aluminum packing bag until you are ready to use it.
- Store the cartridge in an area where the average temperature is 0° to 35°C (32° to 95°F).
- Allow the cartridge to adjust to room temperature for at least one hour when moving a cartridge from a cold location to a hot location.
- Do not leave the cartridge exposed to direct sunlight.
- Do not stand the cartridge on its end or lay it upside down.
- Do not attempt to disassemble the cartridge or open the light blocking shutters. Exposing the cartridge to light may result in poor print quality.
- Do not open the drum protection shutter. Touching the photosensitive drum will damage it and cause problems with print quality.

### 7.3 Replacing the EP-S Cartridge

When the “16 TONER LOW” message is displayed, it means that the printer is either running out of toner or the toner is not being distributed evenly. Before replacing the EP-S cartridge, make sure that the toner is really depleted. Rock the cartridge back and forth gently to redistribute any remaining toner as shown in Figure 7–1.

**Figure 7–1: Rocking the EP-S Cartridge**

MLO-004362 (Figure 7-25; 16.5 picas)

Reinstall the cartridge and try printing. If the toner low message does not appear or printing is acceptable, the cartridge will last for a while longer. If the toner low message remains on and the print quality is not acceptable, you need to replace the EP-S cartridge.

Replacing the EP-S cartridge requires the following:

- Cleaning the fixing roller
- Replacing the fixing roller cleaner
- Cleaning the transfer corona wires and discharging pins

You should perform all of these procedures each time you replace the EP-S cartridge to ensure optimum print performance.

To replace the EP-S cartridge, follow the instructions that come with the cartridge or use the following procedure.

1. Be sure the printer is not printing and the display reads 00 READY.
2. Press the power switch on the back of the printer to the O (OFF) position.

MLO-005117 (Figure 7-26; 15 picas)

3. Press the release button forward and then down.
  - The top cover releases and opens slightly.

MLO-005118 (Figure 7-27; 15.5 picas)

4. Open the top cover to its halfway position.

MLO-004893 (Figure 7-28; 14.5 picas)

5. Remove the EP-S cartridge by pulling it out from the top cover.
  - ✓ Open the top cover to its full upright position after removing the cartridge.

MLO-004890 (Figure 7-29; 18 picas)



6. Open the green fixing assembly cover.

**WARNING:** *The fixing assembly may be hot. Be careful when accessing the fixing unit.*

MLO-004354 (Figure 7-30; 16.5 picas)

7. Remove the used fixing roller cleaner from the fixing assembly.  
✓ Discard the used fixing roller cleaner.

MLO-004879 (Figure 7-31; 16 picas)

8. Wipe the fixing roller with the cleaning pad on the end of the new cleaner.

MLO-004355 (Figure 7-32; 16.5 picas)

9. Peel off the cleaning pad and discard it.

MLO-004356 (Figure 7-33; 16.5 picas)

10. Insert the new cleaner into the fixing assembly.

MLO-004357 (Figure 7-34; 16.5 picas)

11. Close the fixing assembly cover.

**NOTE:** *The fixing assembly cover does not close tightly.*

MLO-004358 (Figure 7-35; 16.5 picas)

12. Wipe the paper feed area (black plastic) clean with a cloth dampened with water.

**CAUTION:** *To prevent possible damage to the internal and external surfaces of the printer, do not use cleaners or solvents. Use a clean cloth dampened with water only.*

MLO-004871 (Figure 7-36; 16 picas)

13. Wipe the transfer area clean with the dampened cloth. The transfer area consists of the following components:
- The movable transfer guide (with green handle) and clear plastic strip
  - The metal transfer roller
  - The silver-colored metal transfer guide

MLO-004872 (Figure 7-37; 16 picas)

14. Clean the transfer corona wire and the nylon separation wires with the cotton swab.

**CAUTION:** *The corona wire and nylon separation wires are fragile. Do not press down on the wires too hard or they may break.*

MLO-004877 (Figure 7-38; 14.5 picas)

15. Remove the wire/pin cleaner from the inside of the printer.

**WARNING:** *The fixing assembly may be hot. Be careful when removing the wire/pin cleaner from the printer.*

MLO-004873 (Figure 7-39; 16 picas)



16. Clean the discharging pins in the groove using the brush end of the cleaner.

**CAUTION:** *You must lift the brush over the separation wires as you clean along the groove. Be careful not to break the wires as you clean the pins.*

MLO-004876 (Figure 7-40; 20 picas)

17. Return the wire/pin cleaner to its storage location in the printer.

MLO-004873 (Figure 7-41; 16 picas)

18. Rock the new EP-S cartridge five or six times as shown to distribute the toner evenly.

MLO-004362 (Figure 7-42; 16.5 picas)

19. Lower the top cover to its partially opened position and install the new cartridge.

MLO-004889 (Figure 7-43; 18 picas)

20. Snap the tab from the left side of the cartridge by moving it up and down.

MLO-004364 (Figure 7-44; 16.5 picas)

21. Grasp the tab and pull the sealing tape completely out of the cartridge.

✓ Discard the sealing tape.

**NOTE:** *The sealing tape is about 55 cm (22") long and may have toner on it. If you get toner on your hands or clothing, wash them with cold water and soap.*

MLO-004365 (Figure 7-45; 16.5 picas)

22. Close the top cover by pushing down on the hand grip until it snaps into place.

MLO-005120 (Figure 7-46; 16 picas)

## 7.4 Replacing the Ozone Filter

The DEClaser 2200 printer is equipped with a disposable ozone filter that must be replaced after each 100,000 printed pages. See Appendix B for ordering information.

Use the following procedure to replace the ozone filter.

**WARNING:** *Never operate the printer without the ozone filter installed. The filter removes ozone, which could be hazardous to your health.*

1. Be sure the printer is not printing and the display reads 00 READY.
2. Press the power switch on the back of the printer to the O (OFF) position.

MLO-005117 (Figure 7-47; 15 picas)

3. Press the release button forward and then down.
  - The top cover will release and open slightly.

MLO-005118 (Figure 7-48; 15.5 picas)

4. Lift the top cover open.

MLO-004531 (Figure 7-49; 13.5 picas)



5. Pull down the ozone filter cover to access the filter.

**WARNING:** *The fixing assembly may be hot. Be careful when accessing the ozone filter.*

MLO-004880 (Figure 7-50; 16 picas)

6. Remove the filter by pulling it out by its tab.

MLO-004881 (Figure 7-51; 16 picas)

7. Grasp the new filter by its tab and slide it into place.

**CAUTION:** *Always handle the filter by its tab and not by its mesh sides. The mesh sides are fragile and can be damaged easily.*

MLO-004882 (Figure 7-52; 16 picas)

8. Fold the filter tab in and close the filter cover until it snaps into place.

MLO-004883 (Figure 7-53; 16 picas)

## Chapter 8

# Service

---

If you cannot correct a problem with the DEClaser 2200 printer, request servicing by a qualified Digital Customer Services engineer. This chapter lists the available services.

### 8.1 Digital Equipment Corporation Services

Digital Equipment Corporation provides a wide range of maintenance programs for printers. These include on-site, carry-in, and mail-in maintenance services. You can use these programs to select a plan that meets your service needs, from complete Digital support to self-maintenance.

Digital offers fast, low-cost, quality maintenance performed at your site by trained service specialists. Whether you select the DECservice or Basic Service agreements, or choose the Time and Materials service, your printer will receive the best possible maintenance.

There are more than 150 Digital carry-in service centers in major cities around the world. These service centers offer convenient, fast, and dependable maintenance at a savings over on-site service.

If you prefer self-maintenance, you can mail in your field replaceable unit (FRU) for repair through our fast-turnaround DECmailer repair service.

For more information on any of Digital Equipment Corporation's maintenance services, call the Digital Customer Services office in your area during normal business hours. Refer to the list of questions in Table 8-1 before calling the service center.

**Table 8-1: Questions to Consider Before You Call**

---

<i>Is the call necessary?</i>	Check Chapter 6. Often you can solve the problem yourself.
<i>Who should call for service?</i>	Typically, the system manager should place the call for service.
<i>Where should you call?</i>	<p>In the continental United States: If you purchased on-site warranty support at the time of sale, call Digital at 1-800-DEC-8000.</p> <p>If you do not have on-site warranty support and are returning the printer to Digital for service, call 1-800-225-5385.</p> <p>For per call service information, call your local sales office.</p> <p>In Alaska, Hawaii, Canada, and Europe: Call your local sales office for service.</p>
<i>What does the service center need to know?</i>	Write down the serial and model numbers located on the label above the rear output tray.
<i>How should you describe the problem?</i>	<p>Summarize the problem. Make a note of:</p> <ul style="list-style-type: none"><li>• What you were doing when the printer failed</li><li>• Any messages on the display panel</li><li>• Any strange noises</li></ul> <p>Stay by the printer and host system if possible, because the service engineer may ask you to recreate the problem.</p>

---

## Appendix A

# DEClaser Printer Quick Reference Guide

---

This quick reference guide contains basic information on using certain programming instructions with your DEClaser printer.

For quick reference use, see these sections:

---

<b>Category</b>	<b>Section</b>
Positioning Controls	A.1
Margins and Spacing	A.2
Set/Reset Modes	A.3
Fonts and Character Sets	A.4
Miscellaneous	A.5

---

## **A.1 Positioning Controls**

### **CUU—Cursor Up**

CSI Pn A

Where:

Pn = 0 is treated as 1.

Pn = n is the numeric value according to SSU sequence and PUM setting.

### **DECCAHT—Clear All Horizontal Tabs**

ESC 2

### **DECCA VT—Clear All Vertical Tabs**

ESC 4

### **DECHTS—Horizontal Tab Set**

ESC 1

### **DECSHTS—Set Horizontal Tab Stops**

CSI Pn ; . . . ; Pn u

### **DECSVTS—Set Vertical Tab Stops**

CSI Pn ; . . . ; Pn v

### **DECVTS—Vertical Tab Set**

ESC 3

### **HPA—Horizontal Position Absolute**

CSI Pn `

Where:

Pn = 0 is treated as 1.

Pn = n is the numeric value according to SSU sequence and PUM setting.

### **HPB—Horizontal Position Backward**

CSI Pn j

Where:

Pn = 0 is treated as 1.

Pn = n is the numeric value according to SSU sequence and PUM setting.

### **HPR—Horizontal Position Relative**

CSI Pn a

Where:

Pn = 0 is treated as 1.

Pn = n is the numeric value according to SSU sequence and PUM setting.

### **TBC—Tab Clear**

CSI Ps ; . . . ; Ps g

Where:

Ps = 0 is clear one horizontal tab stop at active column.

Ps = 1 is clear one vertical tab stop at active line.

Ps = 2 is clear all horizontal tab stops.

Ps = 3 is clear all horizontal tab stops.

Ps = 4 is clear all vertical tab stops.

### **VPA—Vertical Position Absolute**

CSI Pn d

Where:

Pn = 0 is treated as 1.

Pn = n is the numeric value according to SSU sequence and PUM setting.

### **VPB—Vertical Position Backward**

CSI Pn k

Where:

Pn = 0 is treated as 1.

Pn = n is the numeric value, according to SSU sequence and PUM setting.

### **VPR—Vertical Position Relative**

CSI Pn e

Where:

Pn = 0 is treated as 1.

Pn = n is the numeric value, according to SSU sequence and PUM setting.



## A.2 Margins and Spacing

### DEC SHORP—Set Horizontal Pitch

CSI Ps w

Where:

Ps = 0	is determined by current font
Ps = 1	is 720 centipoints (10 characters/inch)
Ps = 2	is 600 centipoints (12 characters/inch)
Ps = 3	is 545 centipoints (13.2 characters/inch)
Ps = 4	is 436 centipoints (16.5 characters/inch)
Ps = 5	is 1440 centipoints (5 characters/inch)
Ps = 6	is 1200 centipoints (6 characters/inch)
Ps = 7	is 1090 centipoints (6.6 characters/inch)
Ps = 8	is 872 centipoints (8.25 characters/inch)
Ps = 9	is 480 centipoints (15 characters/inch)
Ps = 11	is 421 centipoints (approx. 17.1 characters/inch, or more accurately 14/240 inch)
Ps = 12	is 840 centipoints (approx. 8.55 characters/inch, or more accurately 28/240 inch)
Ps = 13	is 400 centipoints (18 characters/inch)
Ps = 14	is 800 centipoints (9 characters/inch)
Ps = 15	is 696 centipoints (approx. 10.3 characters/inch, or more accurately 29/300 inch)

### DEC SLPP—Set Lines per Physical Page

CSI Pn t

### DEC SLRM—Set Left and Right Margins

CSI Pn1 ; Pn2 s

Where:

- Pn1 is the left margin-setting numeric value.
- Pn2 is the right margin-setting numeric value.

## **DECSTBM—Set Top and Bottom Margins**

CSI Pn1 ; Pn2 r

Where:

Pn1 = Top margin-setting numeric value.

Pn2 = Bottom margin-setting numeric value.

## **DECVERP—Set Vertical Pitch**

CSI Ps z

Where:

Ps = 0 is determined by the current font

Ps = 1 is 1200 centipoints (6 lines/inch)

Ps = 2 is 900 centipoints (8 lines/inch)

Ps = 3 is 600 centipoints (12 lines/inch)

Ps = 4 is 3600 centipoints (2 lines/inch)

Ps = 5 is 2400 centipoints (3 lines/inch)

Ps = 6 is 1800 centipoints (4 lines/inch)

Ps = 10 is 1152 centipoints (66 lines/A-size printable area)

Ps = 11 is 1152 centipoints (66 lines/A-size printable area)

Ps = 12 is 864 centipoints (88 lines/A-size printable area)

Ps = 13 is 576 centipoints (132 lines/A-size printable area)

## **DECVPFS—Variable Page Format Select**

CSI Ps1 ; Pn2 ; ... Pn11 SP z

Where:

Ps = 0, 1 is portrait orientation.

Ps = 2 is landscape orientation.

Ps = Other is portrait orientation.

**Table A-1: DECVFSS Selective Parameters**

<b>Pn =</b>	<b>Meaning</b>	<b>If "Zero"</b>
2	Length of paper	Default <sup>1</sup>
3	Width of paper	Default
4	Top margin	0
5	Bottom margin	Bound of printable area
6	Left margin	0
7	Right margin	Bound of printable area
8	Page home line	Top margin
9	Page end line	Bottom margin
10	Line home position	Left margin
11	Line end position	Right margin

<sup>1</sup>The length and width default to the active paper tray values.

### **GSM—Graphic Size Modification**

CSI Pn1 ; Pn2 SP B

Where:

Pn1 = 0 is treated as 100.

Pn = Decimal value is the percentage of the height set by GSS.

Pn2 = 0 is treated as 100.

Pn = Decimal value is the percentage of the width set by GSS.

### **GSS—Graphic Size Select**

CSI Pn SP C

Where:

Pn = 0 is 10 points.

Pn = n is the font height according to SSU sequence.

## **PFS—Page Format Select**

CSI Ps SP J

CSI ?Ps SP J—(Digital Private)

### **Where:**

Ps = 0	Portrait normal text.
Ps = 1	Landscape normal text.
Ps = 2	Portrait normal A4.
Ps = 3	Landscape normal A4.
Ps = 4	Portrait normal North American letter.
Ps = 5	Landscape normal North American letter.
Ps = 6	Portrait extended A4.
Ps = 7	Landscape extended A4.
Ps = 8	Portrait extended legal.
Ps = 9	Landscape extended legal.
Ps = ?20	Portrait extended North American private.
Ps = ?21	Landscape extended North American private.
Ps = ?22	Portrait extended A4 private.
Ps = ?23	Landscape extended A4 private.
Ps = ?24	Portrait extended legal private.
Ps = ?25	Landscape extended legal private.

## **SHS—Set Horizontal Spacing**

CSI Ps SP K

### **Where:**

Ps = 0	is 720 centipoints (10 characters/inch)
Ps = 1	is 600 centipoints (12 characters/inch)
Ps = 2	is 480 centipoints (15 characters/inch)
Ps = 3	is 1200 centipoints (6 characters/inch)

## **SPI—Spacing Pitch Increment**

CSI Pv ; Ph SP G

### **Where:**

Pv = 0 is determined by current font.

Pv = n is the vertical spacing increment numeric value.

Ph = 0 is determined by current font.

Ph = n is the horizontal spacing increment numeric value.

## **SSU—Select Size Unit**

CSI Ps SP I

CSI ?Ps SP I—(Digital Private)

### **Where:**

Ps = 2 is decipoint 1/720 inch.

Ps = 7 is pixel 1/300 inch.

Ps = ?1 is centipoint 1/7200 inch.

## **SVS—Set Vertical Spacing**

CSI Ps SP L

### **Where:**

Ps = 0 is 1200 centipoints (6 lines/inch, 1/6 inch)

Ps = 1 is 1800 centipoints (4 lines/inch, 1/4 inch)

Ps = 2 is 2400 centipoints (3 lines/inch, 1/3 inch)

Ps = 3 is 600 centipoints (12 lines/inch, 1/12 inch)

Ps = 4 is 900 centipoints (8 lines/inch, 1/8 inch)

Ps = 5 is 1416 centipoints (6 lines/30 mm, 5 mm)

Ps = 6 is 2136 centipoints (4 lines/30 mm, 7.5 mm)

Ps = 7 is 2856 centipoints (3 lines/30 mm, 10 mm)

Ps = 8 is 720 centipoints (12 lines/30 mm, 2.5 mm)

Ps = 9 is 3600 centipoints (2 lines/inch, 1/2 inch)

## **A.3 Set/Reset Modes**

### **CRM—Control Representation Mode**

CSI 3 h Set

CSI 3 l Reset

### **DECAWM—Autowrap Mode**

CSI ? 7 h Set

CSI ? 7 l Reset

### **DECCRNLM—Carriage Return/New Line Mode**

CSI ? 4 0 h Set

CSI ? 4 0 l Reset

### **DECOPM—Origin Placement Mode**

CSI ? 5 2 h Set

CSI ? 5 2 l Reset

### **DECPSM—Horizontal Pitch Select Mode**

CSI ? 2 9 h Set

CSI ? 2 9 l Reset

### **DECPSP—Proportional Spacing Mode**

CSI ? 2 7 h Set

CSI ? 2 7 l Reset

### **LNLM—Line Feed/New Line Mode**

CSI 2 0 h Set

CSI 2 0 l Reset

## **PUM—Positioning Unit Mode**

CSI 11 h     Set

CSI 11 l     Reset

## **A.4 Fonts and Character Sets**

### **ASCEF—Announce Subset of Code Extension Facilities**

ESC SP F

If the final character is:

L     is ISO 4873, Level 1.

M     is ISO 4873, Level 2.

N     is ISO 4773, Level 3.

### **DECATFF—Assign to Type Family or Font**

DCS Ps1 ; Ps2 } id\_string ST

Where:

Ps1 = 0, 1     assigns a font collection plus by a 16-character font identifier to SGR number.

Ps1 = 2     assigns type family ID (7 characters) to SGR number.

Ps1 = 3     assigns a 16-character font ID to SGR number.

Ps1 = 4     assigns a 12-character font collection ID to SGR number.

Ps2 = 10     is the primary font.

Ps2 = 11     is the first alternative.

Ps2 = 12     is the second alternative.

·  
·  
·

Ps2 = 19     is the ninth alternative.

## **DECAUPSS—Assign User-Preference Supplemental Character Set**

DSC Ps ! u D . . . D ST

Where:

Ps = 0 is a 94-character graphic character set.

Ps = 1 is a 96-character graphic character set.

Possible D . . . D values:

2/5,3/5 DEC Supplemental (Ps = 0)

4/1 ISO Latin-1 Supplemental (Ps = 1)

4/9 JIS Katakana (Ps = 0)

2/2,3/4 DEC Hebrew Supplemental (Ps = 0)

4/8 ISO Latin-Hebrew Supplemental (Ps = 1)

## **DECDTFF—Delete Type Family or Font File**

DCS Ps ~ id\_string ST

Where:

Ps = 0 is the ID string for a 7-character type family ID.

Ps = 1 is the ID string for a 31-character font file ID.

## **DECLFF—Load Font File**

DCS Ps1 ; Ps2 ; Ps3 y font\_record, font\_record; comment\_record ST

Where:

Ps1 = 0 is Digital Font File Format.

Ps2 = 0 is print summary sheet.

Ps2 = 1 is do not print summary sheet.

Ps3 = 0 is replace all fonts.

Ps3 = 1 is replace loaded font files with same ID as loaded font file.



**LS1R—Locking Shift 1 Right**

ESC ~

**LS2—Locking Shift 2**

ESC n

**LS3—Locking Shift 3**

ESC o

**LS2R—Locking Shift 2 Right**

ESC }

**LS3R—Locking Shift 3 Right**

ESC |

**SCS—Select Character Set**

ESC I\* . . . In F

<b>I* Character</b>	<b>Code</b>	<b>Set Selection</b>
<b>94-Character Sets</b>		
( Left parenthesis	2/8	G0
) Right parenthesis	2/9	G1
* Asterisk	2/10	G2
+ Plus sign	2/11	G3
<b>96-Character Sets<sup>1</sup></b>		
- Hyphen	2/13	G1
. Period	2/14	G2
/ Slash	2/15	G3

---

<sup>1</sup>You cannot designate a 96-character graphic character set into G0.

---

**Table A-2: SCS—Select Character Set**

<b>G0</b>	<b>G1</b>	<b>G2</b>	<b>G3</b>	<b>Character Set</b>
ESC ( B	ESC ) B	ESC * B	ESC + B	ASCII
ESC ( A	ESC ) A	ESC * A	ESC + A	British NRCS
ESC ( 5	ESC ) 5	ESC * 5	ESC + 5	Finnish NRCS
ESC ( R	ESC ) R	ESC * R	ESC + R	French NRCS
ESC ( 9	ESC ) 9	ESC * 9	ESC + 9	DEC French-Canadian NRCS
ESC ( K	ESC ) K	ESC * K	ESC + K	German NRCS
ESC ( Y	ESC ) Y	ESC * Y	ESC + Y	ISO Italian NRCS
ESC ( J	ESC ) J	ESC * J	ESC + J	JIS Roman
ESC ( I	ESC ) I	ESC * I	ESC + I	JIS Katakana
ESC ( 6	ESC ) 6	ESC * 6	ESC + 6	Norwegian/Danish NRCS
ESC ( Z	ESC ) Z	ESC * Z	ESC + Z	Spanish NRCS
ESC ( 7	ESC ) 7	ESC * 7	ESC + 7	DEC Sweden
ESC ( <	ESC ) <	ESC * <	ESC + <	User Preference Supplemental Set
ESC ( 0	ESC ) 0	ESC * 0	ESC + 0	DEC Special Graphics
ESC ( >	ESC ) >	ESC * >	ESC + >	DEC Technical
ESC ( ')	ESC ) ')	ESC * ')	ESC + ')	Norwegian/Danish NRCS
ESC ( 4	ESC ) 4	ESC * 4	ESC + 4	DEC Dutch NRCS
ESC ( =	ESC ) =	ESC * =	ESC + =	DEC Swiss NRCS
ESC ( % 6	ESC ) % 6	ESC * % 6	ESC + % 6	DEC Portuguese NRCS
N/A	ESC - A	ESC . A	ESC / A	ISO Latin-1 Supplemental <sup>1</sup>
ESC ( % 5	ESC ) % 5	ESC * % 5	ESC + % 5	DEC Supplemental
N/A	ESC - H	ESC . H	ESC / H	ISO Latin-Hebrew Supplemental <sup>1</sup>
ESC ( " 4	ESC ) " 4	ESC * " 4	ESC + " 4	DEC Hebrew Supplemental
ESC ( % =	ESC ) % =	ESC * % =	ESC + % =	DEC 7-Bit Hebrew

<sup>1</sup>This is a 96-character set.

**Table A-3: NRC Fallback Selection**

<b>G0</b>	<b>G1</b>	<b>G2</b>	<b>G3</b>	<b>Character Set</b>
ESC ( C	ESC ) C	ESC * C	ESC + C	(Fallback to Finnish NRCS)
ESC ( Q	ESC ) Q	ESC * Q	ESC + Q	(Fallback to DEC French-Canadian NRCS)
ESC ( E	ESC ) E	ESC * E	ESC + E	(Fallback to Norwegian/Danish NRCS)
ESC ( H	ESC ) H	ESC * H	ESC + H	(Fallback to DEC Swedish)

**SGR—Select Graphic Rendition**

CSI Ps ; Ps ; Ps m

CSI ?Ps ; Ps ; Ps m—(Digital Private)

**Where:**

Ps = 0 or none	Turns off all attributes (standard and private).
Ps = 1	Turns on bold.
Ps = 3	Turns on italics.
Ps = 4	Turns on underline.
Ps = 9	Turns on strike-through.
Ps = 10	Use as defined by DECATFF.
.	.
.	.
.	.
Ps = 19	Use as defined by DECATFF.
Ps = 21	Turns on double underline.
Ps = 22	Turns off bold.
Ps = 23	Turns off italics.
Ps = 24	Turns off underline.
Ps = 29	Turns off strike-through.
Ps = 53	Turns on overline.
Ps = 55	Turns off overline.

**Table A-4: Selective Digital Private Parameters**

---

<b>Ps =</b>	<b>Meaning</b>
?0	All private attributes off. <sup>1</sup>
?4	Superscript on, subscript off.
?5	Subscript on, superscript off.
?6	Overline.
?24	Turn off superscript and subscript.
?26	Turn off overline.

---

<sup>1</sup>For purposes of turning private SGR attributes off, overline is considered a private sequence. Overline is always turned off by '?0', regardless of how it was turned on (?6 or 53). Superscript and subscript modes are private attributes only, and therefore are reset by "?0".

---

## **A.5 Miscellaneous**

### **CPR—Cursor Position Report**

CSI Pnv ; Pnh R

Where:

Pnv Numeric parameter describing the active vertical position.

Pnh Numeric parameter describing the active horizontal position.

### **DA—Device Attributes**

CSI c Request primary DA

### **DA2—Device Attributes (Secondary)**

CSI > c Request secondary DA

### **DAR—Response to Device Attributes (DA) Request**

CSI ? Ps1 ; Ps2 ; . . . ; Psn c

## **DA2R—Device Attributes (Secondary) Report**

CSI > Ps1 ; Ps2 ; Ps3 ; Ps4 c

## **DECASFC—Automatic Sheet Feeder (input tray) Control**

CSI Ps ! v

Where:

Ps = 0    No tray change.

Ps = 1    Top tray.

Ps = 2    Bottom tray (not used with DEClaser 2100 printer).

Ps = 3    Envelope feeder (not used with DEClaser 2100 printer).

Ps = 99   Manual feed.

## **DECFIN—Document Finishing**

CSI Ps ! }

Where:

Ps = 0    Default.

Ps = 1    Toggles the offset.

## **DECFSR—Font Status Report**

If RFS is 1 or 0:

DCS 1 " { id\_string ST

If RFS is 2 or 0:

DCS 2 " { nnn ST

Where:

*nnn* indicates the number of bytes available in memory for downline loading.

## **DECMM—Memory Management**

CSI Ps + v

### **Where:**

- Ps = 0, 1 No guaranteed imaging capabilities.
- Ps = 2 A or A4 sized image guaranteed without complexity errors.
- Ps = 3 Legal size image guaranteed without complexity errors.
- Ps = 4 A or A4 sized image guaranteed without complexity errors in duplex mode.
- Ps = 5 Legal size image guaranteed without complexity errors in duplex mode.

## **DECNS—New Sheet**

CSI SP s

## **DECRFS—Request Font Status**

CSI ps " {

### **Where:**

- Ps = 0 Send both reports (same as 1 and 2).
- Ps = 1 Send font status (includes all built-in fonts, downline load fonts, and cartridge fonts).
- Ps = 2 Send status of memory bytes available for downline load fonts.

## **DECRVEC—Draw Relative Vector**

CSI Ps1 ; Pn2 ; Pn3 ; SP |

### **Where:**

- Ps = 0 is draw an X line to the right.
- Ps = 1 is draw a Y line down.
- Ps = 2 is draw an X line to the left.
- Ps = 3 is draw a Y line up.
  
- Pn = 2 is the line length according is SSU sequence.
- Pn = 3 is the line width according to SSU sequence.

## DECSCL—Set Conformance Level

CSI Ps1 ; " p

Where:

Ps1 = 0 is treated as 73.

Ps1 = 71 character cell, Level 1 printers.

Ps1 = 72 character cell, Level 2 printers.

Ps1 = 73 proportional, Level 3 printers.

## DECSDPM—Set Duplex Print Mode

CSI Ps SP x

---

<b>Ps</b>	<b>Print Mode</b>	<b>Physical State</b>	<b>Tumbling State</b>	<b>DEClaser 2100 Fallback</b>	<b>DEClaser 2200 Fallback</b>
0	True simplex normal	Simplex	Off	–	–
1	True simplex normal	Simplex	Off	1	1
2	True simplex tumbled	Simplex	On	1	1
3	True duplex normal	Duplex	Off	5	3
4	True duplex tumbled	Duplex	On	5	4
5	Duplex master normal	Simplex	Off	5	5
6	Duplex master tumbled	Simplex	On	5	6
7	Simplex compressed normal	Duplex	Off	1	7
8	Simplex compressed tumbled	Duplex	On	1	7

---

### **DECSNC—Set Number of Copies**

CSI Pn & q

**Where:**

Pn = 0 is treated as 1.

Pn = 1–99 is the number of copies.

Pn = >99 is treated as 99.

### **DECSSS—Set Sheet Size**

CSI Pn1 ; Pn2 ; Pn3 ; Pn4 SP {

**Where:**

Pn1 = 0 is any slot.

Pn1 = 1 is top tray.

Pn1 = 99 is manual feed.

Pn = 2 is key number (ignored).

Pn = 3 is width (defined as leading edge).

Pn = 4 is length.



## **DECSTR—Soft Terminal Reset**

CSI ! p

## **DECVEC—Draw Vector**

CSI Ps1 ; Pn2 ; Pn3 ; Pn4 ; Pn5 ! |

### **Where:**

P<sub>s</sub> = 0 is draw X (horizontal) line.

P<sub>s</sub> = 1 is draw Y (vertical) line.

P<sub>s</sub> = Other is perform no action.

P<sub>n</sub>2 = X is X (horizontal line) start position (according to SSU sequence).

P<sub>n</sub>3 = Y is Y (vertical line) start position (according to SSU sequence).

P<sub>n</sub>4 is line length (according to SSU sequence).

P<sub>n</sub>5 is line width (according to SSU sequence).

## **DSR—Device Status Request**

CSI Ps n

CSI ?Ps n

### **Where:**

Ps = 0,5 Send an extended status report.

Ps = 6 Send a cursor position report.

Ps = ?1 Disable all unsolicited status reports.

Ps = ?2 Enable brief unsolicited status reports, send extended status report.

Ps = ?3 Enable extended unsolicited status report, send extended status report.

## **JFY—Justify**

CSI Ps SP F

### **Where:**

Ps = 0 is stop justification.

Ps = 2 is justify with limits.

Ps = ?2 is justify without limits.

## **RIS—Reset to Initial State**

ESC c

## **SnC1R—C1 Receive Mode**

CSI SP 6—(Interpret C1 as C0)

CSI SP 7—(Interpret C1 as C1)

## Appendix B

# Accessories and Supplies

---

This appendix lists some of the accessories and supplies available for the DEClaser 2200 printer. Contact your local sales representative or refer to your latest DECdirect catalog for a complete list of products and the latest pricing information. See Section B.1 for additional ordering information.

**Table B-1: DEClaser 2200 Printer Accessories and Supplies**

Part Number	Description
LNXX-CA	CG Times proportional font cartridge
LNXX-CB	CG Triumvirate proportional font cartridge
LNXX-CC	ITC Souvenir and Script proportional font cartridge
LNXX-CD	Monospaced font cartridge
LNXX-CN	CaPSL ROM cartridge
LNXXR-PS	PostScript cartridge
LN06R-UA	PostScript upgrade kit
LNXX-LA	Legal-size paper cassette (8 ½" x 14")
LNXX-LB	A4-size paper cassette (297 mm x 210 mm)
LNXX-LE	Executive-size paper cassette (7 ¼" x 10 ½")
LNXX-LN	Envelope cassette
LNXX-LT	Letter-size paper cassette (8 ½" x 11")
LNXX-UC	1 MB RAM module
LNXX-UD	2 MB RAM module
LNXX-UE	3 MB RAM module
LNXX-AC	EP-S Cartridge Supplies Kit (quantity = 1)
LNXX-XA	EP-S Cartridge Supplies Kit (quantity = 4)
LNXX-XB	EP-S Cartridge Supplies Kit (quantity = 16)

**Table B-1 (Cont.): DEClaser 2200 Printer Accessories and Supplies**

<b>Part Number</b>	<b>Description</b>
LNXX-XC	EP-S Cartridge Supplies Kit (quantity = 64)
LN03X-AE	Mobile printer cabinet/stand
H8571D-A	25-pin male-to-MMJ adapter
H8571D-B	9-pin male-to-MMJ adapter (Digital)
H8571-C	25-pin cable-to-MMJ adapter
H8571-D	25-pin female-to-MMJ adapter (modem)
H8571-J	9-pin PC type-to-MMJ adapter
H8673-AA	20mA active host Mate-N-Lock to EIA-423 DECconnect MMJ passive converter
H8673-AB	20mA active host RJ11 (6-pin) to EIA-423 DECconnect MMJ passive converter
H9850-TA	Laser labels (30/sheet x 100 sheets per box)
H9850-TB	Laser labels (21/sheet x 100 sheets per box)
BC19M-10	IBM/Centronics parallel cable
LN01X-AB	Letter-size paper 8 ½" x 11" 5,000 sheets per box
LN01X-AD	A4-size paper 297 mm x 210 mm 5,000 sheets per box
LN01X-AC	Legal-size paper 8 ½" x 14" 5,000 sheets per box
LN03X-AJ	Letter-size transparencies 8 ½" x 11" 50 sheets per box
LN03X-AK	A4-size transparencies 297 mm x 210 mm 50 sheets per box
29-28272-01	Replacement ozone filter
	<b>NOTE:</b> <i>The replacement ozone filter is available through self-maintenance services. Call 1-800-344-4825 to order the filter.</i>

## B.1 Ordering Information

Use the following mailing addresses and telephone numbers to order products for the DEClaser 2200 printer.

### Table B-2: Ordering Within the U.S.A.

---

<b>MAIL</b>	Digital Equipment Corporation PO Box CS2008 Nashua, NH 03061
<b>TELEPHONE</b>	Order toll free 1-800-DIGITAL (DECdirect) between the hours of 8:30 a.m. and 8:00 p.m. EST

---

### Table B-3: Ordering Outside the U.S.A.

---

<b>MAIL</b>	Digital Equipment Corporation Attention: Accessories & Supplies Business Manager c/o Local Subsidiary or Digital-Approved Distributor
<b>TELEPHONE</b>	
In Canada	Order toll free 1-800-267-6215
In Australia	Outside Sydney Metropolitan Area (toll free): 008-226-363 From Sydney Metropolitan Area: 412-7000
In New Zealand	Auckland (toll free): 0800-800-332

---

## Appendix C

# Specifications

---

This appendix contains the operating and interface specifications for the DEClaser 2200 printer.

### C.1 Operating Specifications

<b>Type:</b>	Desktop page printer
<b>Printing Method:</b>	Electrophotographic using laser beam scanning
<b>Laser Power:</b>	5 mW maximum
<b>Resolution:</b>	300 dpi
<b>Printing Speed:</b>	8 pages/minute maximum using A4 or Letter-size paper from the cassette
<b>Warm-Up Time:</b>	Less than one minute at 20°C (68°F)
<b>Paper Cassettes:</b>	200-sheet capacity Letter (8 ½" x 11") A4 (297 mm x 182 mm) Executive (7 ¼" x 10 ½") Legal (8 ½" x 14")
<b>Manual Feed:</b>	One sheet at a time 100 mm x 190 mm (3.9" x 7 ½") to 216 mm x 356 mm (8 ½" x 14")
<b>Top Output Tray Capacity:</b>	100 sheets (facedown stacking)
<b>Rear Output Tray Capacity:</b>	20 sheets (faceup stacking)
<b>Paper Weight Range Cassette Feed:</b>	60 g/m <sup>2</sup> to 80 g/m <sup>2</sup> basis weight (16 lb. to 21 lb.)
<b>Paper Weight Range Manual Feed:</b>	60 g/m <sup>2</sup> to 135 g/m <sup>2</sup> basis weight (16 lb. to 35 lb.)

<b>Built-in Font Files:</b>	<p>The DEClaser 2200 has 36 built-in font files. The font files consist of four fonts and nine character sets. These fonts are:</p> <ul style="list-style-type: none"> <li>• Courier 10-point normal<sup>1</sup> portrait</li> <li>• Courier 10.3-point normal portrait</li> <li>• Courier 6.7-point normal landscape</li> <li>• Elite 12-point normal portrait</li> </ul> <p>For each font the following character sets reside in the printer:</p> <ul style="list-style-type: none"> <li>• ASCII</li> <li>• DEC Supplemental</li> <li>• ISO Latin-1 Supplemental</li> <li>• DEC Technical</li> <li>• DEC Special Graphics (VT100 Line Drawing)</li> <li>• DEC 7-Bit Hebrew</li> <li>• DEC Hebrew Supplemental</li> <li>• ISO Latin-Hebrew Supplemental</li> <li>• Legal</li> </ul>
<b>Font Cartridges:</b>	Capacity for two optional font cartridges
<b>Built-in RAM:</b>	1.0 MB, expandable to 4.0 MB with optional RAM boards
<b>Host Interface:</b>	Parallel (Centronics) and serial (RS232C)
<b>Acoustic Noise:</b>	40dB(A) maximum during standby 53dB(A) maximum during printing
<b>Operating Temperature:</b>	10°C to 32.5°C (50°F to 90.5°F)
<b>Operating Humidity:</b>	20% to 80% relative humidity
<b>Storage Temperature:</b>	0°C to 35°C (32°F to 95°F)
<b>Storage Humidity:</b>	10% to 80% relative humidity
<b>Power Requirements:</b>	100–115 VAC, 50/60 Hz 220–240 VAC, 50 Hz

---

<sup>1</sup>Normal means that the font is not set in bold or italics or otherwise attributed.

**Power Consumption:**

100–115 V models = 940 W maximum  
220–240 V models = 890 W maximum

13

**Installed Weight (Body Only):**

Approximately 30.4 kg (67.1 lb.)

**Dimensions:**

Width: 454 mm (17.9")  
Depth: 665 mm (26.0")  
Depth: 888 mm (35.0")  
(with A4 paper cassette installed and the rear  
output tray opened)  
Height: 332 mm (12.7")



## C.2 Serial Interface Specifications

Table C-1 lists the pin signals for the RS232C serial interface connector. Figure C-1 shows the pin assignments on the connector. Figure C-2 and Figure C-3 show the serial connections with and without connection to a modem.

**Table C-1: Serial Interface Pin Assignment**

Pin	Signal	Direction
1	Frame Ground	–
2	Transmit Data	Out
3	Receive Data	In
4	Request to Send	Out
5	Not Used	–
6	Data Set Ready	In
7	Signal Ground	–
8–19	Not Used	–
20	Data Terminal Ready	Out
21–25	Not Used	–

**Figure C-1: RS232C Pin Assignments**

MLO-004884 (Figure C-1; 8.5 picas)

**Figure C-2: Serial Connections to Modem**

MLO-004885 (Figure C-2; 19 picas)

**Figure C-3: Serial Connections Without Modem**

MLO-004887 (Figure C-3; 23.5 picas)

### **C.3 Parallel Interface Specifications**

Table C-2 lists the pin signals for the parallel (Centronics) interface connector. Figure C-4 shows the pin assignments on the connector, and Figure C-5 shows the parallel connections to an external device.

**Table C-2: Parallel Interface Pin Assignments**

<b>Pin</b>	<b>Signal</b>	<b>Direction</b>
1	$\overline{DataStrobe}$	In
2	Data 1	In
3	Data 2	In
4	Data 3	In
5	Data 4	In
6	Data 5	In
7	Data 6	In
8	Data 7	In
9	Data 8	In
10	$\overline{ACK}$	Out
11	Busy	Out
12	Call (PE)	Out
13	Select	Out
14–15	Not Connected	–
16	0 Volts (Logic Ground)	–
17	Chassis Ground	–
18	5 Volts	Out
19–29	Ground	–
30	$\overline{InputPrimeRet}$	Out
31	$\overline{InputPrime}$	In
32	$\overline{Fault}$	Out
33	Aux Out 1 <sup>1</sup>	–
34	Not Connected	–
35	Aux Out 2 <sup>1</sup>	–
36	Not Connected	–

<sup>1</sup>Ignored

**Figure C-4: Parallel Pin Assignment**

MLO-004886 (Figure C-4; 7.5 picas)

**Figure C-5: Parallel Connections**

MLO-004888 (Figure C-5; 15.5 picas)

## Appendix D

# LN03 Compatibility

---

This appendix contains information highlighting the differences between the DEClaser 2200 printer and the LN03 printer. This information is directed at the differences affecting compatibility between the printers.

### D.1 General Differences

The following list identifies the general differences between the LN03 printer and the DEClaser 2200 printer.

- A 25-pin serial cable (female) and an MMJ-to-25 pin male adapter are provided with the DEClaser 2200 printer. The LN03 does not come with an interface cable.
- Font cartridges for the DEClaser 2200 printer do not have the same physical format, or the same internal data format, as the font cartridges for the LN03. If your application requires special cartridges (logos, signatures, private character sets), you need to use a soft copy or have a new cartridge made.
- The DEClaser 2200 printer comes with 512 KB of RAM, and can be upgraded up to 3.5 MB. The available memory is 284 KB up to 3.284 MB. This memory is not dedicated as it is on the LN03. For example, the LN03 PLUS option is dedicated to bitmap processing while the RAM cartridges are dedicated to font storage. On the DEClaser 2200 printer you can use the available memory for font storage, bitmap storage, or a display list. When you want to ensure the availability of bitmap memory, use DEC Memory Management (DECMM), or the paint feature in the INITIAL menu (Table 4–12) to allot the proper memory space. When you want to ensure the availability of font memory, load the fonts at the beginning of the print job.
- The DEClaser 2200 printer does not use DIP switches to select features. Instead it uses setup menus and a nonvolatile memory to select and save features. The DEClaser 2200 also uses coded keys on the paper cassettes to indicate paper size.
- When the DEClaser 2200 encounters a “page too complex” error, it stops until the error is cleared using the Error Skip key (see Section 6.1).

## D.2 Printable Area Compatibility

The printable area on the DEClaser 2200 is approximately the same as the printable area on the LN03 printer. There is an approximate ¼" non-printable area around the page.

This difference does not affect applications using the predefined Page Format Selections (PFS) or applications that do not print within ¼" of the paper edge. When the LN03 printer encounters a character that exceeds the printable area, it attempts (in some instances) to shift the character so that it falls within the printable area. The DEClaser 2200 printer does not image any characters that exceed the printable area. This results in lost characters.

## D.3 Protocol Compatibility

The following list contains protocol compatibility issues between the LN03 printer and the DEClaser 2200 printer.

- The LN03 rounds a relative motion of 1 decipoint down to a relative motion of 0, causing cumulative errors; the DEClaser 2200 printer keeps its position accurately. This produces a side effect when a relative motion of 0 is interpreted as a relative motion of 1 by both devices when using decipoints. This leads to 0 motion on the LN03, and a 1 decipoint motion on the DEClaser 2200.
- When trying to image past the bottom margin, the LN03 does not always wrap. Wrapping depends on the glyph shape and the line spacing. For example, “j” may print but “a” may not. The DEClaser 2200 always wraps if the character box crosses the bottom margin, even though the character may not have a descender. This ensures that all characters either print, or all characters wrap, to the next page.
- You should use the level 3 device identification for the DEClaser 2200 when possible. This allows the software to be compatible with any future devices.

Some applications, such as DECmate, require you to set the printer up to respond as an LN03 printer. When the device identification is set to LN03, it responds as a base model LN03, not an LN03 PLUS, even though it may have sufficient memory for a full bitmap. See Section 4.5.5.1 for additional information about the device identification.

- The DEClaser 2200 does not support Tektronix mode; the LN03 PLUS does.



- The DEClaser 2200 does not contain the Modern Gothic font resident in the LN03 PLUS.
- If a font used on the page is deleted to free up memory for another requirement, the DEClaser 2200 may cause a page break. It does not try to transfer the display list to bitmap memory like the LN03 PLUS would. If you encounter page breaks, set the paint feature value to Full (see Table 4–12).

**NOTE:** *The Full value can be activated only if at least 1 MB of optional RAM is installed in the printer.*

- When a font report is issued, the DEC Supplemental character set is now reported as 245 (94-character set %5), rather than 010 (94-character set <) which is now the User Preference character set. The DEClaser 2200 has three Hebrew character sets and the Legal character set resident in the printer. This also modifies the font status report because more fonts are included.
- The DEClaser enforces the Common Font File Format (CFFF) syntax and semantics more strictly than the LN03. Therefore, some fonts containing errors, which load correctly on the LN03, may not load properly on the DEClaser 2200 and will generate an error report.
- The DEClaser 2200 can save more user default settings in NVRAM than the LN03 can save using DIP switches. Therefore, when a reset command is received, more values can be saved in the DEClaser 2200. To ensure that values are not cleared during a reset, save them to NVRAM whenever possible.

# Glossary

---

**ASCII**

Abbreviation for American Standard Code for Information Interchange. The ASCII code table is widely used for data processing and communication. The codes listed represent a set of characters and commands.

**A4 paper size**

The European paper size of 210 mm x 297 mm.

**basis weight**

A measurement used to describe the paper weight density in grams per square meter. Acceptable basis weight ranges for the printer are from 60 g/m<sup>2</sup> to 135 g/m<sup>2</sup>, or the equivalent of 16 lb. to 36 lb. To determine the basis weight in pounds, divide the g/m<sup>2</sup> by 3.75.

**baud rate**

The speed (bits/second) at which the computer and the printer communicate when a serial interface is used.

**bitmap**

An image in digitized form that can be stored, transmitted, and reproduced precisely.

**bitmap font**

The type of font created from a bitmap pattern. A bitmap font has a fixed size, similar to the type set in typography. The Courier font that resides in the DEClaser 2200 printer is an example of a bitmap font.

**buffer**

An area in the printer's memory used for temporary storage of data during input and output operations.

**built-in fonts**

Fonts that reside in memory and are shipped with the printer. These fonts are sometimes referred to as internal, or resident fonts.

**CaPSL**

Abbreviation for Canon Printing System Language. This page description language uses escape sequences to control the printer.

**character attribute**

A feature of a highlighted character. You can select underlining, bold printing, italic printing, and strike-through attributes.

**character set**

A set of codes that describe the general appearance of a set of characters. For example, a character set might contain the code for an uppercase A or the number 1. Character sets do not describe the style (font) of a printed character.

**command**

An instruction that tells the printer to perform a certain function. Commands are sent from the host computer to the printer when the printer is on line.

**configuration**

The process of changing the settings of the printer or computer to communicate properly with each other. For example, if you use a serial interface, features such as baud rate and rsmode must be configured to match the host computer and printer.

**default**

A value or setting the printer assumes unless specific changes are made. For example, the interface default value for the DEClaser 2200 printer is RS232C (serial). Default values are stored in ROM and cannot be changed.

**downline loaded fonts**

Fonts that are transferred (downline loaded) from the host computer and temporarily stored in the printer's memory. The downline loaded fonts have priority over the built-in fonts and are cleared when you use a software command or when you power off the printer.

**dpi**

Abbreviation for dots per inch. Dpi is a unit of measurement to indicate printer resolution. The DEClaser 2200 printer has a print resolution of 300 dpi.

**DTR**

Abbreviation for Data Terminal Ready. DTR is a control signal used with RS232C serial communication. DTR regulates the flow of data to the input

**Glossary-2**

buffer of the printer by placing a high or low voltage on the DTR line of the serial port. DTR is sometimes known as “hardware handshaking protocol.”

**duplex**

A layout indicating that a document is to be printed on two sides. The DEClaser 2200 printer can perform duplex printing.

**EP-S cartridge**

Abbreviation for electrophotographic supply cartridge. The EP-S cartridge contains toner, a photosensitive drum, a cleaning mechanism for excess toner, and the primary corona wire.

**error skip**

The process of acknowledging an error (by pressing ) and then continuing to print. Some errors cannot be bypassed with the error skip procedure.

**fixing assembly**

The fixing assembly contains heat and pressure rollers that bond the toner to the paper. The fixing assembly is sometimes referred to as a fusing unit.

**font**

The artistic representation of a typeface that describes a set of characters by point size, weight, and style.

**font attributes**

The seven characteristics of a font that define how printed characters look when you use that font: type family, spacing, type size, scale factor, typeset, character weight, and character proportion. These attributes are not affected by the character set you use.

**font file**

A data file that contains information used to reproduce a particular font.

**font file ID**

A 31-character code that describes the character set and font attributes for a given font file.

**font ID**

A 16-character code that describes the seven basic font attributes (including type family) of the ROM fonts. The code cannot contain lowercase letters.

**host**

The computer that provides services and enables startup and management of the peripheral devices, such as printers.

**image area**

The printable portion of a page. Like most printers, the DEClaser 2200 does not allow printing to the physical edge of the page.

**initialize**

To set starting values such as counters, switches, or addresses, at the beginning of, or at prescribed points in a computer routine.

**interface**

Connects two devices (through the interface cable) such as a computer and printer, making it possible for them to communicate with each other. The DEClaser 2200 printer supports a parallel (Centronics) and a serial (RS232C) interface.

**landscape printing**

A method of printing characters parallel to the long edge of the paper. Landscape printing is typically used for printing wide charts or tables.

**LCD**

Abbreviation for liquid crystal display. The printer messages appear on the LCD, which is part of the control panel.

**letter size**

The North American paper size of 8 ½" x 11".

**line weight**

The thickness of a line. The thicker the line, the heavier the line weight.

**menu**

Menus contain the features and values to configure the printer. For example, the LAYOUT menu contains features such as offsetX and offsetY, which are used to configure margins on the page. There are six menus for the DEClaser 2200 printer that in total constitute the current printer settings.

**moisture content**

The ratio of water to the dry mass of paper. The moisture content can vary depending on the type of paper and the amount of humidity it is exposed to.

**NVRAM**

Abbreviation for nonvolatile random-access memory. Nonvolatile means that data is retained in NVRAM even after the printer is powered off. NVRAM is particularly useful when you are setting up the printer configuration, because all of the values can be saved and retained.

**off line**

A communications mode during which the printer cannot receive data from the host computer. When the On Line indicator is off, it indicates that the printer is off line.

**on line**

A communications mode during which the printer can receive data from the host computer. When the On Line indicator is on, it indicates that the printer is on line.

**operating memory**

Contains the current print settings loaded from NVRAM, and any modifications. Operating memory is RAM, and is cleared when the printer is powered off. Operating memory is sometimes known as “working memory.”

**ozone filter**

Removes ozone generated by the printer. The ozone filter should be replaced every 100,000 pages. Never operate the printer without the ozone filter installed. Operating the printer without the ozone filter installed could be hazardous to your health.

**page**

In the context of a laser printer, the image you are printing; you can print up to two pages per sheet (one page per side).

**parallel interface**

A data communications interface that transmits multiple bits of data (usually in 1-byte segments) simultaneously. The DEClaser 2200 printer uses a Centronics parallel interface.

**portrait printing**

A method of printing characters parallel to the short edge of the paper. This is the normal page orientation for printing. For example, this page is printed in a portrait orientation.

**PostScript language**

A programming language designed to convey a description of a desired page to a printer. It can describe a page containing any combination of text, graphical shapes, and digitized images.

**primary corona wire**

A wire located inside the EP-S cartridge that places an electrical charge on the photosensitive drum, preparing it to accept an image from the laser beam.

**printer controller firmware**

The firmware that interprets the data in a print request according to a specified data syntax, builds bitmaps of each page to be printed, and forwards the bitmaps to the print engine, which produces the hardcopy output.

**print density**

The relative thickness of the line used to print characters. The thicker the line, the darker and denser it looks. The thickness of a line is known as the "line weight."

**printer software**

The software that handles the communications between the process that makes a print request (terminal), the process that provides resources (a host), and the process that performs the printing service (a print queue).

**protocol**

A procedure or set of rules that controls the communication between computers and peripherals. Also, a set of conventions between communicating processes regarding the format and contents of messages to be exchanged.

**RAM**

Abbreviation for random-access memory. RAM retains data only while power remains on. Data is cleared from RAM when the printer is powered off. The DEClaser 2200 printer contains 1.5 MB of built-in RAM, which is expandable up to 4.5 MB with optional memory boards.

**reset**

A procedure that clears data in the print buffer and returns the printer to the ready state. The printer operates using the settings stored in RAM. These settings are loaded into operating memory when a reset is performed.

**resolution**

The number of dots in a defined area. The resolution of the DEClaser 2200 printer is 300 dpi.

**ROM**

Abbreviation for read-only memory. ROM contains all of the factory default feature values. It is a permanent memory and cannot be cleared or changed.

**serial interface**

A data communications interface that transmits data sequentially, one bit at a time, at a fixed speed. The DEClaser 2200 printer uses an RS232C serial interface.

**sheet**

In the context of a laser printer, the physical piece of paper that is printed.

**simplex**

A layout indicating that a document is formatted to be printed on one side of a sheet.

**toner**

A black powder commonly known as dry ink, which is used to form the characters on the paper. Toner is contained in the EP-S cartridge on the DEClaser 2200 printer.

**transfer corona wire**

Places an electronic charge on the paper that attracts (transfers) toner from the photosensitive drum to the paper.

**type family**

A group of fonts that have a similar design, but differ in the six other font attributes. For example, Courier is a type family that resides in the DEClaser 2200 printer.

**type family ID**

A 7-character code that identifies a type family.

**xon/xoff**

A software protocol used with RS232C serial communication. It regulates the flow of data to the input buffer by exchanging on/off signals with the host computer. The xon/xoff protocol is sometimes referred to as “software handshaking protocol.”



# Index

---

## A

---

Accessories and supplies, B-1  
Associated documents, xiv  
Automatic new line feature, 4-23

## B

---

Baud rate feature, 4-30  
Buffer control feature (xon/xoff),  
4-30

## C

---

CDRH regulations, xvii  
Cleaning  
  discharging pins, 7-14  
  internal surfaces, 7-2  
  primary corona wire, 7-7  
  the printer, 7-1  
  transfer corona wires, 7-14  
COMMAND menu, 4-23  
Common operating problems, 6-7  
Configuring the printer, 4-1  
Control panel, 3-1  
Control Representation Mode, 2-48  
COPY menu, 4-23

## D

---

Data terminal ready (dtr) feature,  
4-30  
DECLASER Printer Quick Reference  
  Guide, A-1  
Discharging pins, 7-14  
Document structure, xii  
Dtr, 4-30  
DUPLEX menu, 4-31  
Duplex printing, 2-11

Duplex printing (Cont.)  
  printer setup, 2-12

## E

---

Engine Test Print, 2-35  
Envelopes  
  manual feeding, 2-26  
  special considerations, 5-7  
  specifications, 5-4  
EP-S cartridge  
  care of, 7-20  
  replacing, 7-21  
Error skip procedure, 6-1  
Etx/ack (end of text/acknowledge  
  feature), 4-31

## F

---

Features  
  automatic new line, 4-23  
  baud rate, 4-30  
  buffer control (xon/xoff), 4-30  
  data terminal ready (dtr), 4-30  
  displaying, 4-4  
  end of text/acknowledge (etx/ack),  
    4-31  
  interface selection, 4-29  
  macro, 4-25  
  offset position, 4-21  
  paint mode, 4-27  
  paper size, 4-27  
  RS232C data format, 4-30  
FEEDER menu, 4-18  
Font List, 2-45

## I

---

INITIAL menu, 4-24 to 4-27

INTERFACE menu, 4-28 to 4-31  
Interface selection feature, 4-29

## K

---

Keypad  
in Keypad Mode, 3-4  
in Menu Mode, 3-7, 4-3

## L

---

Labels  
special considerations, 5-10  
specifications, 5-9  
Laser safety, xvii  
LAYOUT menu, 4-20 to 4-23  
LN03 compatibility, D-1

## M

---

Macro feature, 4-25  
examples, 4-27  
Maintenance, 7-1  
Manual feed operation, 2-18  
envelopes, 2-26  
paper, labels, transparencies,  
2-20  
Memory  
nonvolatile random-access, 4-8  
operating, 4-6  
random-access, 4-9  
read-only, 4-7  
Menu  
COMMAND, 4-23  
COPY, 4-23  
DUPLEX, 4-31  
FEEDER, 4-18  
INITIAL, 4-24  
INTERFACE, 4-28  
LAYOUT, 4-20  
Menu descriptions, 4-15  
Menu mode, 4-2 to 4-3  
Menu mode display, 4-4 to 4-5  
Menus  
displaying, 4-4  
Messages

Messages (Cont.)  
operator call, 6-3  
printer status, 6-2  
service call, 6-7  
software error, 6-5

## N

---

Nonvolatile random-access memory,  
4-8  
NVRAM, 4-8

## O

---

Offset position feature, 4-21  
Operating memory, 4-6  
Operating space, 1-10  
Operational flow in Menu Mode, 4-9  
Operator call messages, 6-3  
Output tray  
in simplex mode, 2-8  
rear, 2-10  
top, 2-9  
Output tray selection, 2-7 to 2-10  
Ozone filter replacement, 7-39  
Ozone safety, xvi

## P

---

Paint mode feature, 4-27  
Paper  
loading, 2-14  
manual feed, 2-18  
special considerations, 5-3  
specifications, 5-2  
Paper handling, 5-11  
Paper jams, 6-12  
lower paper path area, 6-22  
paper feed, transfer, and fixing  
assembly areas, 6-17  
paper reversing area, 6-26  
top and rear paper trays, 6-13  
Paper size feature, 4-27  
Paper storage, 5-11  
Power off, 2-3  
Power on, 2-1

Print density adjustment, 2–32  
Printer components and functions,  
1–1, 1–3, 1–4, 1–9  
Printer configuration memory, 4–5  
to 4–9  
Printer status messages, 6–2  
Print media, 5–1

## Q

---

Quick Reference Guide  
fonts and character sets, A–11  
miscellaneous, A–16  
positioning controls, A–2  
set/reset modes, A–10

## R

---

RAM, 4–9  
Random-access memory, 4–9  
Read-only memory, 4–7  
Replacement procedures  
EP-S cartridge, 7–21  
ozone filter, 7–39  
Resetting the printer, 2–49  
ROM, 4–7  
RS232C data format feature, 4–30

## S

---

Safety information, xvi  
CDRH regulations, xvii  
laser, xvii  
ozone, xvi  
Service, 8–1  
Service call messages, 6–7  
Software error messages, 6–5  
Software requirements, xii  
Specifications  
envelopes, 5–4  
labels, 5–9  
operating, C–1  
paper, 5–2  
parallel interface, C–7  
serial interface, C–4  
transparencies, 5–8

## T

---

Test Print A, 2–38  
Test Print B, 2–42  
Test prints  
Engine Test Print, 2–35  
Test Print A, 2–38  
Test Print B, 2–42  
Top cover  
closing, 2–6  
opening, 2–4  
Transfer corona wire, 7–14  
Transparencies  
special considerations, 5–8  
specifications, 5–8  
Troubleshooting, 6–1

## V

---

Values  
changing and saving, 4–11 to  
4–14  
displaying, 4–5

## X

---

Xon/xoff, 4–30