

# **DEClaser 1100 Printer Operator's Guide**

Order Number EK-DCL11-OP-002

**Digital Equipment Corporation  
Maynard, Massachusetts**

---

**First Printing, January 1991**  
**Revised, June 1991**

The information in this document is subject to change without notice and should not be construed as a commitment by Digital Equipment Corporation.

Digital Equipment Corporation assumes no responsibility for any errors that may appear in this document.

Any software described in this document is furnished under a license and may be used or copied only in accordance with the terms of such license. No responsibility is assumed for the use or reliability of software or equipment that is not supplied by Digital Equipment Corporation or its affiliated companies.

Restricted Rights: Use, duplication, or disclosure by the U.S. Government is subject to restrictions as set forth in subparagraph (c)(1)(ii) of the Rights in Technical Data and Computer Software clause at DFARS 252.227-7013.

© Digital Equipment Corporation 1991  
All rights reserved. Printed in U.S.A.

The Reader's Comments form at the end of this document requests your critical evaluation to assist in preparing future documentation.

The following are trademarks of Digital Equipment Corporation: DECdirect, DEClaser, DECmailer, DECmate, DECservice, LN03, LN03 PLUS, VAX DOCUMENT, and the DIGITAL logo.

IBM is a registered trademark of International Business Machines Corporation and ProPrinter is a trademark of International Business Machines Corporation. PostScript is a registered trademark of Adobe Systems, Inc. HP and LaserJet are registered trademarks of Hewlett-Packard Company. Microsoft is a registered trademark of Microsoft Corporation. WordPerfect is a trademark of WordPerfect Corporation.

S1703

This document was prepared using VAX DOCUMENT, Version 1.2.

---

**First Printing, January 1991**  
**Revised, June 1991**

The information in this document is subject to change without notice and should not be construed as a commitment by Digital Equipment Corporation.

Digital Equipment Corporation assumes no responsibility for any errors that may appear in this document.

Any software described in this document is furnished under a license and may be used or copied only in accordance with the terms of such license. No responsibility is assumed for the use or reliability of software or equipment that is not supplied by Digital Equipment Corporation or its affiliated companies.

Restricted Rights: Use, duplication, or disclosure by the U.S. Government is subject to restrictions as set forth in subparagraph (c)(1)(ii) of the Rights in Technical Data and Computer Software clause at DFARS 252.227-7013.

© Digital Equipment Corporation 1991  
All rights reserved. Printed in Japan.

The Reader's Comments form at the end of this document requests your critical evaluation to assist in preparing future documentation.

The following are trademarks of Digital Equipment Corporation: DECdirect, DEClaser, DECmailer, DECmate, DECservice, LN03, LN03 PLUS, VAX DOCUMENT, and the DIGITAL logo.

IBM is a registered trademark of International Business Machines Corporation and ProPrinter is a trademark of International Business Machines Corporation. PostScript is a registered trademark of Adobe Systems, Inc. HP and LaserJet are registered trademarks of Hewlett-Packard Company. Microsoft is a registered trademark of Microsoft Corporation. WordPerfect is a trademark of WordPerfect Corporation.

S1703

This document was prepared using VAX DOCUMENT, Version 1.2.

**FCC NOTICE:** This equipment generates and uses radio frequency energy and if not installed and used properly, that is, in strict accordance with the manufacturer's instructions, may cause interference to radio and television reception. It has been type tested and found to comply with the limits for a Class B computing device in accordance with the specifications in Subpart J of Part 15 of FCC Rules, which are designed to provide reasonable protection against such interference in a residential installation. However, there is no guarantee that interference will not occur in a particular installation. If this equipment does cause interference to radio or television reception, which can be determined by turning the equipment off and on, the user is encouraged to try to correct the interference by one or more of the following methods.

- Reorient the receiving antenna.
- Relocate the computer or peripheral with respect to the receiver.
- Move the computer or peripheral away from the receiver.
- Plug the computer or peripheral into a different outlet so that they are on different branch circuits than the receiver.

If necessary, the user should consult the dealer or an experienced radio/television technician for additional suggestions. The user may find the booklet *How to Identify and Resolve Radio/TV Interference Problems*, prepared by the Federal Communications Commission helpful. This booklet is available from the U.S. Government Printing Office, Washington, DC 20402, Stock No. 004-000-00345-4.

To meet FCC requirements a shielded parallel cable is required to connect the device to a personal computer or other Class B device.

# Contents

---

Preface	ix
---------	----

---

## Chapter 1 Printer Components

---

1.1 Functions of the Printer Components	1-1
1.2 Required Operating Space	1-9

## Chapter 2 Operating Information

---

2.1 Powering the Printer On	2-1
2.2 Powering the Printer Off	2-3
2.3 Opening the Paper Tray	2-4
2.4 Adding Paper	2-6
2.4.1 Loading the Paper Tray	2-7
2.5 Changing the Page Format Size	2-11
2.6 Printing on Envelopes	2-12
2.6.1 Loading Envelopes	2-12
2.7 Selecting the Output Tray	2-18
2.7.1 Selecting the Top Output Tray (Facedown Print)	2-20
2.7.2 Selecting the Front Output Tray (Faceup Print)	2-22
2.8 Adjusting the Print Density	2-24
2.9 Printing Test Print A	2-27
2.10 Printing Test Print B	2-30
2.11 Printing the Font List	2-32
2.12 Using Control Representation Mode	2-34
2.12.1 Entering Control Representation Mode	2-35
2.13 Resetting the Printer	2-36
2.14 Emulation and Video Modes of Operation	2-37

## Chapter 3 The Control Panel

---

3.1	Using the Keypad in Keypad Mode . . . . .	3-5
3.1.1	Entering Keypad Mode . . . . .	3-5
3.2	Using the Keypad in Menu Mode . . . . .	3-8

## Chapter 4 Printer Configuration

---

4.1	Entering Menu Mode . . . . .	4-2
4.1.1	Keypad Functions in Menu Mode . . . . .	4-3
4.2	Reading the Display in Menu Mode . . . . .	4-4
4.2.1	Displaying Menu and Feature Selections . . . . .	4-5
4.2.2	Displaying Menu Values . . . . .	4-6
4.3	Printer Configuration Memory . . . . .	4-6
4.3.1	Operating Memory . . . . .	4-7
4.3.2	ROM (Read-Only Memory) . . . . .	4-8
4.3.3	NVRAM (Nonvolatile Random-Access Memory) . . . . .	4-9
4.3.4	RAM (Random-Access Memory) . . . . .	4-10
4.4	Operational Flow in Menu Mode . . . . .	4-10
4.4.1	Changing and Saving Values Example Procedure . . . . .	4-12
4.5	Menu Descriptions . . . . .	4-14
4.5.1	FEEDER Menu . . . . .	4-16
4.5.2	LAYOUT Menu . . . . .	4-16
4.5.3	COPY Menu . . . . .	4-17
4.5.4	COMMAND Menu . . . . .	4-17
4.5.5	INITIAL Menu . . . . .	4-18
4.5.5.1	Macro . . . . .	4-19
4.5.5.2	Examples Using the Macro Feature . . . . .	4-21
4.5.5.3	Paint Mode (paint) . . . . .	4-22
4.5.5.4	Paper Size (paper) . . . . .	4-22
4.5.6	INTERFACE Menu . . . . .	4-23
4.5.6.1	Interface Selection (i/f) . . . . .	4-25
4.5.6.2	Baud Rate (baud) . . . . .	4-25
4.5.6.3	RS232C Data Format (rsmode) . . . . .	4-25
4.5.6.4	Data Terminal Ready (dtr) . . . . .	4-25
4.5.6.5	Buffer Control (xon/xoff) . . . . .	4-26
4.5.6.6	End of Text/Acknowledge (etx/ack) . . . . .	4-26

## Chapter 5 Print Media

---

5.1	Paper Specifications . . . . .	5-2
5.1.1	Special Considerations When Printing on Paper . . . . .	5-3
5.2	Envelope Specifications . . . . .	5-4
5.2.1	Special Considerations When Printing on Envelopes . . . . .	5-7
5.3	Transparency Specifications . . . . .	5-8
5.3.1	Special Considerations When Printing on Transparencies . . . . .	5-8
5.4	Label Specifications . . . . .	5-9
5.4.1	Special Considerations When Printing on Labels . . . . .	5-10
5.5	Paper Handling and Storage . . . . .	5-10
5.5.1	Paper Handling . . . . .	5-11
5.5.2	Paper Storage . . . . .	5-11

## Chapter 6 Troubleshooting

---

6.1	Error Skip Procedure . . . . .	6-2
6.2	Printer Status Messages . . . . .	6-3
6.3	Operator Call Messages . . . . .	6-4
6.4	Software Error Messages . . . . .	6-6
6.5	Service Call Messages . . . . .	6-8
6.6	Common Operating Problems . . . . .	6-8
6.7	Paper Jams . . . . .	6-12
6.7.1	Clearing Printer Paper Jams . . . . .	6-14
6.7.2	Clearing Cassette Paper Jams . . . . .	6-22

## Chapter 7 Maintenance

---

7.1	Extending EP-L Cartridge Life . . . . .	7-2
7.2	Replacing the EP-L Cartridge . . . . .	7-3
7.3	Cleaning the Fixing Assembly . . . . .	7-10
7.4	Cleaning the Printer . . . . .	7-13

## Chapter 8 Service

---

8.1	Digital Equipment Corporation Services . . . . .	8-1
-----	--	-----

## Appendix A DEClaser Printer Quick Reference Guide

---

A.1	Positioning Controls . . . . .	A-2
A.2	Margins and Spacing . . . . .	A-5
A.3	Set/Reset Modes . . . . .	A-10
A.4	Fonts and Character Sets . . . . .	A-11
A.5	Control Characters . . . . .	A-17
A.6	Miscellaneous . . . . .	A-18

## Appendix B Accessories and Supplies

---

B.1	Ordering Information . . . . .	B-3
-----	--------------------------------	-----

## Appendix C Specifications

---

C.1	Operating Specifications . . . . .	C-1
C.2	Serial Interface Specifications . . . . .	C-4
C.3	Parallel Interface Specifications . . . . .	C-6

## Appendix D LN03 Compatibility

---

D.1	General Differences . . . . .	D-1
D.2	Printable Area Compatibility . . . . .	D-2
D.3	Protocol Compatibility . . . . .	D-2

## Glossary

---

## Index

---



## Figures

---

1-1	Components: Front/Right-Side View	1-2
1-2	Components: Rear/Left-Side View	1-5
1-3	Components: Inside the Printer	1-7
1-4	Operating Space: Top View	1-10
1-5	Operating Space: Side View	1-10
2-1	Output Tray Selections	2-18
2-2	Test Print A	2-27
2-3	Test Print B	2-30
2-4	Font List	2-32
3-1	Control Panel	3-2
4-1	Sample Menu	4-1
4-2	Menu Display	4-5
4-3	Operating Memory	4-7
4-4	Operational Flow Chart	4-11
5-1	Unacceptable Labels	5-9
6-1	Paper Jam Areas	6-13
7-1	Rocking the EP-L Cartridge	7-3
C-1	RS232C Pin Assignments	C-4
C-2	Serial Connections to Modem	C-5
C-3	Serial Connections Without Modem	C-6
C-4	Parallel Pin Assignment	C-8
C-5	Parallel Connections	C-8

## Tables

---

1-1	Printer Components: Front/Right-Side View	1-3
1-2	Printer Components: Rear/Left-Side View	1-6
1-3	Printer Components: Internal View	1-8
2-1	Changing Page Format Size	2-11
2-2	Test Print A	2-28
2-3	Printing Test Print A	2-29
2-4	Printing Test Print B	2-31
2-5	Printing the Font List	2-33
2-6	Entering Control Representation Mode	2-35
2-7	Resetting the Printer	2-36

2-8	Selecting Emulation or Video Mode . . . . .	2-37
3-1	Control Panel Functions . . . . .	3-3
3-2	Entering Keypad Mode . . . . .	3-5
3-3	Keypad Functions: Keypad Mode . . . . .	3-5
4-1	Entering Menu Mode . . . . .	4-2
4-2	Keypad Functions: Menu Mode . . . . .	4-3
4-3	Recalling Factory Default Values from ROM . . . . .	4-8
4-4	Saving Values in NVRAM . . . . .	4-9
4-5	Saving Values in RAM . . . . .	4-10
4-6	Changing and Saving Values . . . . .	4-12
4-7	Menu Mode Features and Values . . . . .	4-14
4-8	FEEDER Menu Features and Values . . . . .	4-16
4-9	LAYOUT Menu Features and Values . . . . .	4-16
4-10	COPY Menu Features and Values . . . . .	4-17
4-11	COMMAND Menu Features and Values . . . . .	4-17
4-12	INITIAL Menu Features and Values . . . . .	4-18
4-13	User Preference Character Set . . . . .	4-19
4-14	Initialization Message . . . . .	4-20
4-15	Device Identification . . . . .	4-20
4-16	Macro Feature Examples . . . . .	4-21
4-17	INTERFACE Menu Features and Values . . . . .	4-23
5-1	Cassette Feed Paper Sizes . . . . .	5-2
5-2	Paper Specifications . . . . .	5-2
5-3	Transparency Sizes . . . . .	5-8
5-4	Transparency Specifications . . . . .	5-8
6-1	Error Skip Procedure . . . . .	6-2
6-2	Printer Status Messages . . . . .	6-3
6-3	Operator Call Messages . . . . .	6-4
6-4	Software Error Messages . . . . .	6-6
6-5	Common Operating Problems . . . . .	6-9
8-1	Questions to Consider Before You Call . . . . .	8-2
B-1	DEClaser 1100 Printer Accessories and Supplies . . . . .	B-1
B-2	Ordering Within the U.S.A. . . . .	B-3
B-3	Ordering Outside the U.S.A. . . . .	B-3
C-1	Serial Interface Pin Assignments . . . . .	C-4
C-2	Parallel Interface Pin Assignments . . . . .	C-7

## Preface

---

The DEClaser 1100 printer uses electrophotographic laser technology to print text and graphics at speeds up to 4 pages/minute with a density of 300 x 300 dots/inch. The printer consists of an engine (print mechanism) and a controller (formatter) that are driven from host-based software to provide shared printer access from the Digital network. The printer is designed as a personal desktop printer for printing up to 5,000 prints per month.

Some of the features of the DEClaser 1100 printer include:

- Capacity for two external (optional) Digital ANSI-compliant font cartridges, or emulation protocol cartridges
- Font downline loading capability
- Support for both serial and parallel interfaces
- Convenient user maintenance (one replaceable supply cartridge)
- Ability to print on paper, envelopes, labels, and transparencies
- Selectable faceup or facedown document delivery
- Support for an external video controller
- Easy-to-read liquid crystal display (LCD) for printer messages

The following options are available for the DEClaser 1100 printer:

- User-installable memory expansion (up to 2 MB)
- Digital ANSI-compliant font cartridges
- Emulation protocol cartridges
- User-installable PostScript upgrade capability
- Paper cassette feeder
- A4, letter-size, legal-size, and executive-size paper cassettes
- Envelope cassette

## Software Requirements

Some features of the DEClaser 1100 printer may or may not be available depending on the operating software used by the host computer system and the application software that you are using. For information about the printer features you can use with your application program, consult your application program documentation.

For help choosing the right software package for your application needs, contact your Digital sales representative.

## Document Structure

This guide focuses mainly on the operational aspects of the DEClaser 1100 and explains how to use and maintain the printer hardware. For printer installation instructions, refer to the *DEClaser 1100 Printer Installation Guide* in this binder.

This guide describes the printer components and their functions, such as loading paper, changing the supply cartridge, and using the operator panel. It also covers the proper maintenance procedures to keep your printer operating efficiently, and basic troubleshooting techniques for correcting common operating problems. The appendices describe accessories and supplies, operating specifications, and programming information. A glossary of terms completes the guide.

This guide is organized as follows:

- Chapter 1, Printer Components, describes the components and features of the DEClaser 1100 printer.
- Chapter 2, Operating Information, covers operating procedures such as powering the printer on, loading paper, and adjusting print density.
- Chapter 3, The Control Panel, covers the use of the printer's control panel. It describes operational information about the indicators, keys, and message display.
- Chapter 4, Printer Configuration, explains how to configure the printer so that it can communicate with your computer system. You configure the printer by selecting features and their associated values from the various setup menus. This chapter also describes how to save the values in memory.
- Chapter 5, Print Media, describes the various printing media that can be used with the DEClaser 1100 printer, including paper, envelopes, transparencies, and labels. It also addresses the proper way to store and handle paper.

- Chapter 6, Troubleshooting, contains basic testing and troubleshooting techniques that allow you to correct common operating problems such as poor printing or paper jams.
- Chapter 7, Maintenance, explains how to care for and maintain the printer. It describes how to replace the electrophotographic laser (EP-L) cartridge, and how to clean the printer.
- Chapter 8, Service, explains how to obtain service if the printer needs repair.
- Appendix A, DEClaser Printer Quick Reference Guide, lists the DEClaser control commands and escape sequences used to program the printer. It is intended as a reference for the experienced programmer.
- Appendix B, Accessories and Supplies, describes the accessories and supplies available for the DEClaser 1100 printer and explains how to order them.
- Appendix C, Specifications, lists the power, environmental, and physical specifications of the DEClaser 1100 printer.
- Appendix D, LN03 Compatibility, highlights some of the major differences between the DEClaser 1100 and the LN03 printers.
- The glossary contains definitions of printer-related terms.

#### **Ordering Additional Copies of This Documentation Set**

The documentation set consists of one of each of the following:

- *DEClaser 1100 Printer Installation Guide*
- *DEClaser 1100 Printer Operator's Guide*
- Spine insert for the binder
- Three-ring binder

You can order additional copies of this documentation set from DECdirect as described in the ordering information section at the end of this guide. The ordering number for the documentation is EK-D1100-DK.

**NOTE:** *You cannot order the installation or operator's guide individually. You can only order the documentation set.*

## Associated Documents

Several other related manuals are available for use with the DEClaser 1100 printer. You can order these optional manuals from DECdirect as described in the ordering information section at the end of this guide.

Those optional manuals are:

- *Digital ANSI-Compliant Printing Protocol Level 3 Programming Reference Manual* (AA-PBWGA-TE) This manual is for application programmers who create software that produces Digital ANSI-compliant level 3 output. It describes printer protocol character processing and printer control functions.
- *Digital ANSI-Compliant Printing Protocol Level 3 Programming Supplement* (AA-PBWHB-TE) Contains device-specific information for programmers who create applications for Digital ANSI-compliant level 3 devices. It is also for programmers who write applications with ANSI output that requires conversion to the PostScript page description language for printing on Digital printers.
- *Digital Laser Printers Guide to Paper and Other Media* (EK-LASER-GD) This manual is for general users and contains detailed information about buying and storing print media (paper, envelopes, labels, and transparencies) that can be used with Digital laser printers.

## Conventions Used in This Guide

The following conventions are used in this guide:

---

Convention	Meaning
<b>NOTE</b>	Notes provide important additional information.
<b>CAUTION</b>	Cautions provide information to prevent damage to equipment.
<b>WARNING</b>	Warnings provide information to prevent personal injury.
<b>Key</b> <span style="border: 1px solid black; padding: 0 2px;">Key</span>	A key name is shown enclosed in a box to indicate that key on the control panel. Key names are always shown in initial capital letters. For example:  1. Press <span style="border: 1px solid black; padding: 0 2px;">On Line</span> to place the printer on line.
<b>Dash (—)</b>	A statement preceded by a dash describes the result of a procedural step. For example:  1. Press <span style="border: 1px solid black; padding: 0 2px;">On Line</span> to place the printer on line.  — The On Line indicator lights.
<b>Check Mark (✓)</b>	A statement marked by a check mark indicates a special instruction related to the procedural step. For example:  1. Insert the paper into the tray until it stops.  ✓ The right edge of the paper should touch the paper feed guide.
<b>UPPERCASE</b>	Printer status messages and operator call messages are shown in uppercase. For example:  — The display reads 00 READY.
<b>Bold</b>	Items from the scrolling menus appear as they do on the display (uppercase, lowercase, or initial capital letters) with the menu item shown in bold type. For example:  1. Press <span style="border: 1px solid black; padding: 0 2px;">Menu</span> to enter Menu Mode.  — The menu display reads <b>FONT/FEED LAYOUT</b> .

---

## **Safety Information**

The DEClaser 1100 printer complies with all United States government safety regulations applicable to laser beam light exposure. Read the following information to become familiar with laser safety.

### **Laser Safety**

The DEClaser 1100 printer complies with 21 CFR Chapter 1, Subchapter J, as a Class 1 laser product under the U.S. Department of Health and Human Services (DHHS) Radiation Performance Standard according to the Radiation Control for Health and Safety Act of 1968. The printer does not emit hazardous light since the laser beam is totally enclosed during all modes of customer operation and maintenance.

**WARNING:** *Use of controls or adjustment procedures other than those specified in this manual may result in hazardous laser light exposure.*

### **CDRH Regulations**

The Center for Devices and Radiological Health (CDRH) of the U.S. Food and Drug Administration implemented regulations for laser products on August 2, 1976. These regulations apply to laser products manufactured beginning August 1, 1976. Compliance is mandatory for products marketed in the United States.



# Chapter 1

## Printer Components

---

This chapter describes the components of the DEClaser 1100 printer and their functions. This chapter also provides information about the operating space required to perform day-to-day printing operations.

### 1.1 Functions of the Printer Components

Figure 1-1, Figure 1-2, and Figure 1-3 show the printer components. Table 1-1, Table 1-2, and Table 1-3 explain the printer components and their functions.

**Figure 1–1: Components: Front/Right-Side View**

MLO-005960

**Table 1–1: Printer Components: Front/Right-Side View**

<b>Component</b>	<b>Function</b>
1. Top Output Tray	Printed sheets are automatically collated and stacked (facedown) here.
2. Paper Stop	Stops the printed paper as it exits the printer. The paper stop helps to stack the paper neatly and can be adjusted for A4, letter-size (LTR), or legal-size (LGL) paper.
3. Font Cartridge Slots	These two slots accept the optional font and emulation protocol cartridges available for the printer.
4. Power Switch	Powers the printer on or off. Pressing “I” turns power on; pressing “O” turns power off. To ensure that data is not lost, always be sure the message display reads 00 READY and the Data indicator is off, before you power off the printer. See Section 2.1 and Section 2.2 for additional information about powering the printer on and off.
5. Front Cover Release Button	Lifting this button unlocks the front cover so it can be opened. The front cover is opened to perform certain printer functions as such replacing the EP-L <sup>1</sup> cartridge or clearing a paper jam.
6. Output Tray Selector	This selector chooses the output delivery tray. The top position sends paper facedown to the top output tray. The bottom position sends paper faceup to the front output tray. Refer to Section 2.7 for additional information about output paper tray selection.
7. Paper Tray	The paper tray holds paper, transparencies, labels, or envelopes and automatically feeds them into the printer. It can hold approximately 50 sheets of 75 g/m <sup>2</sup> basis weight paper (20 lb.). See Section 2.4 for more information about loading print media in the tray.
8. Extension Tray	The extension tray pulls out to support paper or envelopes.
9. Adjustable Paper Guide	The adjustable paper guide slides to the left or right to accommodate the paper size you are using. The paper guide minimizes paper jams by aligning the stack of paper so that each sheet of paper enters the printer properly. See Section 2.4 for more information about loading paper in the tray.

---

<sup>1</sup>EP-L stands for electrophotographic laser.

**Table 1–1 (Cont.): Printer Components: Front/Right-Side View**

<b>Component</b>	<b>Function</b>
10. Fixing Assembly Cover	<p>The fixing assembly cover can be opened to access paper jams that occur in the fixing assembly. See Section 6.7 for more information about clearing paper jams.</p> <p><b>WARNING:</b> <i>The rollers in the fixing assembly may be hot. Be careful when accessing this area.</i></p>
11. Front Cover	<p>The front cover opens so you can replace the EP-L cartridge, adjust the print density, and access printer components.</p>
12. Control Panel	<p>The control panel consists of a message display, indicator lights, and a keypad. The control panel provides information on printer status and can be used to perform certain printer functions such as resetting the printer or configuring the printer. See Chapter 3 for additional information about using the control panel while printing. Chapter 4 has information about using the control panel to configure the printer.</p>
13. Front Output Tray (not shown)	<p>The front output tray is used when you want to stack documents faceup. Refer to Section 2.7.2 for additional information about installing and selecting the front output tray.</p>

**Figure 1–2: Components: Rear/Left-Side View**

MLO-005961

**Table 1–2: Printer Components: Rear/Left-Side View**

<b>Component</b>	<b>Function</b>
1. Air Vent	The cooling fan exhausts air through this vent. Be sure that the printer has adequate space around it to ensure proper ventilation.
2. Memory Board Access Cover	Optional RAM (random-access memory) can be added to the printer. This access cover allows you to install the optional memory boards easily. Refer to the instructions on the memory board packaging for the installation procedure.
3. Power Cord Receptacle	This is where the power cord is connected to the printer.
4. Parallel (Centronics) Interface Cable Connector	This connector is used when the interface cable from the host computer is a parallel cable. Refer to the <i>DEClaser 1100 Printer Installation Guide</i> for more information about connecting your computer to the printer.
5. Video Interface Connector	This connector is used to connect an external video controller to the printer. Input from an external controller allows the DEClaser 1100 to print custom graphic applications at maximum speed. Consult your external video controller documentation for interface information.
6. Serial (RS232C) Interface Cable Connector	This connector is used when the interface cable from the host computer is a serial cable. Refer to the <i>DEClaser 1100 Printer Installation Guide</i> for more information about connecting your computer to the printer.

**Figure 1-3: Components: Inside the Printer**

MLO-005962

**Table 1–3: Printer Components: Internal View**

<b>Component</b>	<b>Function</b>
1. Print Density Adjustment Switch	Sliding this switch to the left lightens the print. Sliding the switch to the right darkens the print. See Section 2.8 for additional information about setting the print density.
2. EP-L Cartridge	<p>The EP-L cartridge contains a photosensitive drum, a primary charge roller, the drum cleaning unit, toner, and a developing unit.</p> <p>When print quality problems (such as light print or white streaks) first appear, it could mean that the toner is not being distributed evenly. Rock the EP-L cartridge several times to redistribute the toner evenly (see Section 7.2). If the print quality problem continues after rocking the cartridge, it means the EP-L cartridge has run out of toner and you should replace it. Each EP-L cartridge comes with replacement instructions, or see Section 7.2 for instructions if necessary.</p>
3. Pickup Roller	The pickup roller feeds the paper from the paper tray into the printer.
4. Fixing Assembly	<p>The fixing assembly consists of a heat roller and a pressure roller. Toner is bonded to the paper as it passes between the heat and pressure rollers.</p> <p><b>WARNING:</b> <i>The rollers in the fixing assembly may be hot. Be careful when accessing this area.</i></p>
5. Transfer Roller	<p>The transfer roller is negatively charged to attract the more positively charged toner from the photosensitive drum. The transfer roller transfers the toner from the drum to the paper.</p> <p><b>CAUTION:</b> <i>Do not touch the transfer roller. Fingerprints can contaminate the roller surface. The transfer roller should be clean at all times to ensure optimum print quality.</i></p>
6. Paper Access Cover	<p>This cover can be opened to access paper jams that occur in this area of the printer. See Section 6.7 for more information about clearing paper jams.</p> <p><b>WARNING:</b> <i>The rollers in the fixing assembly may be hot. Be careful when accessing this area.</i></p>



## 1.2 Required Operating Space

Always allow ample space around the printer to perform day-to-day printing operations. Figure 1-4 and Figure 1-5 show the minimum amount of space required to perform these operations. See the *DEClaser 1100 Printer Installation Guide* for additional information about location requirements and environmental conditions.

**Figure 1–4: Operating Space: Top View**

MLO-005806

**Figure 1–5: Operating Space: Side View**

MLO-005963...Actual pica height is 15.5

## Chapter 2

# Operating Information

---

This chapter provides the operating information necessary to perform day-to-day printer operations. It covers typical tasks such as powering the printer on and off, adding paper, or selecting an output tray.

### 2.1 Powering the Printer On

Power the printer on using the following procedure.

1. Press the power switch on the right side of the printer to the | (ON) position.

MLO-005719

You should observe the following when you power on the printer:

- All control panel indicators light for a moment.
- The Ready indicator flashes and the display reads 02 WARMING UP (assuming that the printer has cooled below operating temperature before it is powered on).
- The Online and Ready indicators remain on and the display reads 00 READY DEC.

**NOTE:** *The display reads 00 READY DEC only if you are using Digital's ANSI-Compliant Printing Protocol level 3. If you are using an optional protocol such as PostScript or CaPSL, the display shows the protocol being used. For instance, if you are using PostScript protocol, the display reads PS READY/IDLE. Since several protocols can be used with the DEClaser 1100 printer, the remainder of this manual shows the ready message as 00 READY.*

If the printer does not power on correctly, refer to Chapter 6 for troubleshooting information.

## 2.2 Powering the Printer Off

Power the printer off using the following procedure.

1. Be sure the printer is not printing and that the Data indicator is not on.

**CAUTION:** *Do not power the printer off while it is printing. Powering the printer off during printing causes paper jams and loss of data. Powering the printer off while the Data indicator is on causes the data in the print buffer to be lost.*

2. Press the power switch on the right side of the printer to the O (OFF) position.

MLO-005822

**NOTE:** *After powering the printer off, always wait at least two seconds before you power the printer back on. This waiting period ensures that the printer will initialize (cycle) properly when it is powered back on.*

## **2.3 Opening the Paper Tray**

Open the paper tray using the following procedure.

1. Open the paper tray by pulling it toward you.

MLO-005824

2. Pull the extension tray straight out.

MLO-005815

## 2.4 Adding Paper

The printer has a built-in paper tray that can accept paper, transparencies, labels, and envelopes. The tray incorporates a convenient adjustable paper feed guide allowing it to accommodate various media sizes including the following:

- Legal-size paper (8 ½ in. x 14 in.)
- Letter-size paper, transparencies, and labels (8 ½ in. x 11 in.)
- A4-size paper, transparencies, and labels (210 mm x 297 mm)
- Executive-size paper (7 ¼ in. x 10 ½ in.)
- Envelopes ranging in size from 97 mm x 148 mm, up to 216 mm x 356 mm

The paper tray can hold up to 50 sheets of 20 lb. (75 g/m<sup>2</sup> basis weight) paper. Up to five envelopes can be stacked in the paper tray. There are optional paper cassettes available to accommodate various sizes of paper. For ordering information about the optional paper feeder and cassettes, see Appendix B.

Here are some general guidelines to follow about the paper used in the printer:

- Use only high-quality paper such as the papers listed in Appendix B.
- Avoid using any paper that is creased, folded, clipped, stapled, or damaged.
- To prevent paper curl (a curved bend in the paper), stack the paper on a flat surface for storage.
- Prevent changes to the moisture content of the paper by storing it properly and rewrapping unused portions. Do not store paper directly on the floor.

Complete specifications for print media are in Chapter 5. For more detailed print media information, consult the *Digital Laser Printers Guide to Paper and Other Media* (see Appendix B for ordering information).



## 2.4.1 Loading the Paper Tray

The loading procedure is the same whether you are adding paper, labels, or transparencies to the paper tray. If you are adding envelopes to the paper tray, see Section 2.6.1 for instructions.

**NOTE:** *Forms, envelopes, and letterhead paper must be loaded facedown into the paper tray to print on the correct side. The front output tray must be used for printing on envelopes, labels, or transparencies (see Section 2.7.2).*

If you are changing the paper size, you must also change the page format size (printing area) to match the new paper size. When changing the page format size, you need to reset the printer to invoke the new size. See Section 2.5 for information about using **Feeder Select** to change the paper format size.

Add paper to the paper tray using the following procedure.

1. Be sure the printer is not printing and that the display reads 00 READY (or 11 TRAY PAPER xx) before adding paper to the tray.
2. Slide the adjustable paper feed guide to the left if you are changing the paper size.

MLO-005965...Actual height is 21.5 picas.

3. Tap the stack of paper on a flat surface to align the edges.

MLO-005967

4. Insert the stack of paper into the tray until it stops.
  - ✓ The right edge of the paper should touch the paper feed guide.
  - ✓ Forms and letterhead paper are loaded facedown, with the top edge first.
  - The Alarm indicator goes off (if it was on).
  - The display reads 00 READY.

MLO-005968

5. Slide the adjustable paper feed guide to the right (if necessary) until it just touches the paper stack.
  - ✓ Do not press the adjustable paper guide against the stack of paper so tightly that it restricts movement of the paper into the printer.
  - ✓ Make sure the paper lies perfectly flat in the tray.
  - ✓ Be sure the paper is below the paper height guides and not above the paper limit line.

MLO-005964

6. Go to Section 2.5 if you are using a new paper size.

## 2.5 Changing the Page Format Size

The page format size determines the printable area on the page and should match the paper size you are using in the paper tray. Table 2–1 describes how to change the format size.

**NOTE:** *The default paper tray size (set in the INITIAL Menu) for 120V model printers is LETTER; for 220/240V model printers the default size is A4. This procedure assumes that the letter-size page format is currently in use.*

**Table 2–1: Changing Page Format Size**

Operation	Display Reads
1. Press <b>On Line</b> to place the printer off line.  – The On Line indicator goes off.	00 READY
2. Press and hold <b>Feeder Select</b> and release when TRAY = LETTER is displayed.	TRAY = LETTER
3. Press <b>Feeder Select</b> repeatedly until the paper format size you want is displayed. Wait about three seconds.  <b>NOTE:</b> <i>If <b>Feeder Select</b> is not pressed after three seconds, the value shown is selected and the display reads 00 READY.</i>	LETTER ↓ LEGAL ↓ EXEC ↓ A4
4. Press and hold <b>Reset</b> for about three seconds.  – The new page size is invoked.	00 READY ↓ 03 RESET ↓ 00 READY
5. Press <b>On Line</b> to place the printer back on line.  – The On Line indicator lights.	00 READY

## 2.6 Printing on Envelopes

Envelopes have the same setup requirements as all other media. Since you print addresses in a particular area on envelopes, you must give the printer the proper print coordinates to print the addresses. Normally the setup requirements for printing envelopes are defined by the application program you are using. Consult your application program documentation for details about its envelope printing feature.

If your application program does not have an envelope printing feature, you need to set up your address files using commands that instruct the printer to print in the correct location on the envelope. Appendix A contains a listing of DEClaser 1100 commands and programming information for the experienced programmer. For detailed programming information necessary to set up your address files, see the *Digital ANSI-Compliant Printing Protocol Level 3 Programming Reference Manual* and the *Digital ANSI-Compliant Printing Protocol Level 3 Programming Supplement*.

### 2.6.1 Loading Envelopes

Always use the front output tray when printing envelopes for faceup stacking. See Section 2.7.2 for information about selecting and installing the front output tray. For clarity, the illustrations in the following procedure do not show the front output tray in place.

Make the following checks before loading envelopes:

- The sealing flap should run along the length of the envelope, not at the leading or trailing edges.
- The sealing flap should be folded properly, with none of the glue exposed.
- The leading and trailing edges should not be more than two layers thick.
- The envelope should be free of any wrinkles or creases.

**CAUTION:** *Using envelopes made of artificial materials (nonpaper), or those that have fasteners, snaps, or windows, can cause serious damage to the printer. See Section 5.2 for complete envelope specifications.*

Use the following procedure to load envelopes in the paper tray.

1. Place one to five envelopes on a flat surface and press down across the surface of the envelopes to expel the air and flatten them.

MLO-005969

2. Align the stack of envelopes by tapping them on a flat surface.

MLO-005970



3. Slide the adjustable paper feed guide to the left side of the paper tray if you are loading a new size of envelope.

MLO-005965

4. Insert the envelopes into the tray as far as they will go.
  - ✓ Envelopes are loaded facedown, so that the top edges of the envelopes are touching the paper feed guide on the right side of the tray.
  - ✓ The envelopes should lie as flat as possible in the tray.
  - The Alarm indicator goes off (if it was on).
  - The display reads 00 READY.

MLO-005971

5. Slide the left paper feed guide to the right (if necessary) until it just touches the envelopes.
  - ✓ Do not press the adjustable paper guide against the stack of envelopes so tightly that it restricts movement of the envelopes into the printer.
  - ✓ Be sure the envelopes are below the paper height guides and not above the paper limit line.

MLO-005972

## **2.7 Selecting the Output Tray**

The DEClaser 1100 can deliver printed output either faceup or facedown, as shown in Figure 2-1. Output tray selection is accomplished by setting the output tray selector to the top or front tray position. You cannot select the output paper tray through a command from the host computer; setting the output tray selector is the only way to choose the output tray.

**Figure 2-1: Output Tray Selections**

MLO-005966

Printed paper is stacked either facedown or faceup, depending on the position of the output tray selector. When the selector is set to the top output tray position, printed paper is delivered facedown to that tray. This allows your print job to be collated in the correct page order.

When the selector is set to the front output tray position, printed paper is delivered faceup to that tray. Although the front output tray can be used to stack paper faceup, it is used primarily to stack envelopes, transparencies, and labels.

**CAUTION:** *To prevent paper jams do not exceed output tray paper capacity. Maximum capacity is 20 sheets for the front output tray, and 50 sheets for the top output tray. Also, do not try to change the output tray while the printer is printing. Changing the output tray while printing causes paper jams.*

### 2.7.1 Selecting the Top Output Tray (Facedown Print)

Printed paper is delivered to the top output tray collated and stacked facedown. The top output tray can be selected manually when you switch from the front output tray; it is also selected automatically whenever the input paper tray is closed.

**NOTE:** *The front output tray must be used for printing on envelopes, labels, or transparencies (see Section 2.7.2).*

Use the following procedure to switch from using the front output tray to using the top output tray.

1. Set the paper stop on the top output tray to the position that accommodates the paper size you are using.

MLO-005974

2. Set the output paper tray selector to the top tray position.
  - ✓ The notch on the selector should be aligned with the top tray indicator on the printer.

MLO-005976

## 2.7.2 Selecting the Front Output Tray (Faceup Print)

Use the following procedure to select and attach the front output tray.

**NOTE:** *When printing on transparencies, it is recommended that you remove each sheet from the output tray before the next is printed.*

1. Set the output paper tray selector to the front tray position.
  - ✓ The notch on the selector should be aligned with the front tray indicator on the printer.

MLO-005975



2. Squeeze the output tray slightly to insert its pegs into the top slots of the printer.

MLO-005818

## 2.8 Adjusting the Print Density

Print density is the term used to describe the amount (density) of toner applied to the paper. The print density adjustment controls the amount of toner applied to the paper to produce a lighter or darker print.

You can significantly extend the life of an electrophotographic laser (EP-L) cartridge by using the lightest possible print density setting that gives you acceptable print quality.

**NOTE:** *The EP-L cartridge life can be up to 3,300 A4 or letter-size pages. This specification is based on 4% toner coverage with the print density set at its default position.*

Use the following procedure to adjust print density.

1. Lift up the release button to open the front cover.
  - The Alarm indicator lights.
  - The display reads 12 PRINTER OPEN.
  - The printer goes off line.

MLO-005808

2. Adjust the print density by moving the switch to the right to make the print darker, or to the left to make the print lighter.
  - The print density adjustment has four settings. As you move the switch, it clicks at each of the middle settings.

MLO-005977

3. Close the front cover by lifting it up and pushing it in until it latches securely in place.
  - The Alarm indicator goes off.
  - The display reads 02 WARMING UP.
  - The display reads 00 READY.

MLO-005814

4. Press On Line to place the printer back on line.
  - The On Line indicator lights.

## 2.9 Printing Test Print A

Test Print A (Figure 2–2) lists the current printer settings along with information such as the firmware version and the amount of free memory available.

**Figure 2–2: Test Print A**

MLO-004851...Actual height is 31 picas.

You can print Test Print A to see what the current printer settings are before making changes in Menu Mode (see Chapter 4). Table 2–2 describes the items on Test Print A, and Table 2–3 describes how to print the test print.

**Table 2–2: Test Print A**

<b>Item</b>	<b>Description</b>
Version	This is the version of internal firmware the printer is using.
Total RAM	This is the total amount of random-access memory (RAM) available in the printer. RAM is shown in kilobytes.
Font Card	This lists the name of the installed font cartridges and their location (left or right font cartridge slot).
Free RAM	This indicates the total amount of RAM available. This memory space can be used to downline load fonts from the host computer, be reserved as bitmap pages, or used to support options such as PostScript.
Current Settings	<p>This shows all of the setup menus and the current values in operational memory. Each menu also shows what kind of memory the values can be stored in: RAM only, nonvolatile RAM (NVRAM) only, or either type of memory (RAM + NVRAM).</p> <p>See Table 4–7 and Section 4.5 for a complete listing and description of all the menu features.</p>

Use the procedure in Table 2-3 to print a copy of Test Print A.

**Table 2-3: Printing Test Print A**

<b>Operation</b>	<b>Display Reads</b>
1. Press <b>On Line</b> to place the printer off line.  – The On Line indicator goes off.	00 READY
2. Press <b>Test/Font</b> once.  – Test Print A prints.	05 TEST PRINT A ↓ 00 READY
3. Press <b>On Line</b> to place the printer back on line.  – The On Line indicator lights.	00 READY

## 2.10 Printing Test Print B

Test Print B (Figure 2–3) contains sample printouts that can be examined for print quality and print density.

**Figure 2–3: Test Print B**

MLO-004852...Actual height is 36 picas.



Test Print B is printed continuously (until instructed to stop) so it can also be used to test paper feed, paper delivery, and other mechanical functions of the printer.

Use the procedure in Table 2–4 to print a copy of Test Print B.

**Table 2–4: Printing Test Print B**

Operation	Display Reads
1. Press <b>[On Line]</b> to place the printer off line. – The On Line indicator goes off.	00 READY
2. Press and hold down <b>[Test/Font]</b> until 01 TEST PRINT B is displayed (about 12 seconds). – The test page prints continuously.	05 TEST PRINT A ↓ 08 CLEANING PAP. ↓ 01 TEST PRINT B
3. Press <b>[Test/Font]</b> to stop printing Test Print B. <b>NOTE:</b> <i>You can also press <b>[On Line]</b> to stop printing Test Print B.</i>	04 TEST STOP ↓ 00 READY
4. Press <b>[On Line]</b> to place the printer back on line. – The On Line indicator lights.	00 READY

## 2.11 Printing the Font List

Figure 2-4 shows the Font List, which contains a listing of all the available character sets in the printer, along with a sample of the available fonts.

**Figure 2-4: Font List**

MLO-004853...Actual height is 36 picas.

The Font List includes internal fonts, cartridge fonts, and fonts that have been downline loaded into memory. You can select fonts only by using commands from the host computer; you cannot select them from the control panel. For information about selecting fonts, refer to the *Digital ANSI-Compliant Printing Protocol Level 3 Programming Reference Manual* and the *Digital ANSI-Compliant Printing Protocol Level 3 Programming Supplement*.

Use the procedure in Table 2-5 to print the font list.

**Table 2-5: Printing the Font List**

Operation	Display Reads
1. Press <b>On Line</b> to place the printer off line. – The On Line indicator goes off.	00 READY
2. Press <b>Test/Font</b> twice. – The font list prints.	06 FONT LIST A ↓ 00 READY
3. Press <b>On Line</b> to place the printer back on line. – The On Line indicator lights.	00 READY

## 2.12 Using Control Representation Mode

Control Representation Mode is used to print out unprocessed data or commands sent from the host computer. This procedure is sometimes referred to as “dumping.” The printing of unprocessed data (in the form of characters and symbols) is convenient for debugging programs. If a specified character is undefined, a hexadecimal representation is printed in its place.

This section explains how to print the character listing. For additional information about Control Representation Mode, consult the *Digital ANSI-Compliant Printing Protocol Level 3 Programming Reference Manual*.

**NOTE:** *If the file does not fill the page buffer completely, the remaining data can be printed by pressing `[On Line]` to place the printer off line, and then pressing `[Form Feed]` to print the partial page.*

### 2.12.1 Entering Control Representation Mode

Use the procedure in Table 2–6 to place the printer in Control Representation Mode.

**Table 2–6: Entering Control Representation Mode**

Operation	Display Reads
1. Press <b>On Line</b> to place the printer off line.  – The On Line indicator goes off.	00 READY
2. Press and hold <b>Reset</b> until 03 DUMP is displayed (about 10 seconds).	03 RESET ↓ 03 DUMP ↓ 03 RESET ↓ 00 READY    DUMP
3. Press <b>On Line</b> to place the printer back on line.  – The On Line indicator lights.  – The printer is now in Control Representation Mode and ready to accept data or commands from the printer.	00 READY    DUMP

To exit Control Representation Mode, perform a soft reset (see Section 2.13).

## 2.13 Resetting the Printer

There are two methods of resetting the printer: You can perform a hard reset by powering the printer off and then back on or you can perform a soft reset by pressing **[Reset]**.

**CAUTION:** *When performing a hard reset, always wait at least two seconds before you power the printer back on.*

Perform a soft reset of the printer under the following circumstances:

- When changing the paper feed input between tray and cassette
- When changing paper tray sizes (see Section 2.5)
- When changing paper cassette sizes
- To clear data in the print buffer
- To invoke features in the INITIAL menu (see Table 4–12)
- To enter and exit Control Representation Mode (see Section 2.12.1)

Use the procedure in Table 2–7 to perform a soft reset.

**Table 2–7: Resetting the Printer**

<b>Operation</b>	<b>Display Reads</b>
1. Press <b>[On Line]</b> to place the printer off line.  – The On Line indicator goes off.	00 READY
2. Press and hold <b>[Reset]</b> for about three seconds.	03 RESET ↓ 00 READY
3. Press <b>[On Line]</b> to place the printer back on line.  – The On Line indicator lights.	00 READY

## 2.14 Emulation and Video Modes of Operation

The DEClaser 1100 operates using Digital's ANSI-compliant level 3 printing protocol (DEC PPL3). If you have an optional emulation cartridge or are using an external video controller, you must select the proper operating mode. Emulation mode is selected when you want to invoke a protocol from an optional emulation cartridge that is installed in the printer. Video mode is selected when you have an external video controller connected to the printer.

Use the procedure in Table 2-8 to select the emulation or video mode of operation.

**Table 2-8: Selecting Emulation or Video Mode**

Operation	Display Reads
1. Press <b>On Line</b> to place the printer off line. <ul style="list-style-type: none"> <li>- The On Line indicator goes off.</li> </ul>	00 READY
2. Press and hold <b>Menu</b> for about three seconds.	MODE = DEC 00
3. Press <b>▶</b> or <b>◀</b> to select the emulation or video mode.	MODE "EMULATION NAME" or MODE VIDEO
4. Press <b>Enter</b> to select and save the mode. <ul style="list-style-type: none"> <li>- The mode is automatically saved in NVRAM.</li> </ul>	MODE = "EMULATION NAME" (for emulation mode) or *00 EX READY (for video mode)
5. Press <b>On Line</b> to place the printer back on line. <ul style="list-style-type: none"> <li>- The On Line indicator lights.</li> </ul>	MODE = "EMULATION NAME" (for emulation mode) or *00 EX READY (for video mode)

## Chapter 3

# The Control Panel

---

The control panel consists of a message display, indicator lights, and a keypad. The keypad allows you to perform certain printer functions such as printing test pages or configuring the printer menus. This chapter explains the features and uses of the control panel.



The layout of the control panel is shown in Figure 3-1 and described in Table 3-1. Table 3-3 describes the key functions in Keypad Mode. See Table 4-2 for the key functions when configuring the printer in Menu Mode.



**Figure 3–1: Control Panel**

MLO-005830

**Table 3–1: Control Panel Functions**

<b>Item</b>	<b>Function</b>
Message Display	<p>Shows the current status of the printer.</p> <p>For example: 00 READY</p> <p>When the printer is in Menu Mode, the display shows the selected menu, feature, or value.</p> <p>For example: <b>COMMAND INITIAL</b></p>
Keypad	<p>Some keys on the keypad perform a dual function depending on whether the printer is in Keypad Mode or Menu Mode. In Keypad Mode, the keys perform the primary function labeled on the key, such as Test/Font. When the printer is in Menu Mode, the keys perform the secondary function labeled with the dark gray symbols and text, such as  or .</p> <p><b>NOTE:</b> All keys and related functions (with the exception of ) work only when the printer is off line.</p> <p>See Section 3.1 for information about using the keypad in Keypad Mode.</p> <p>See Section 4.1 for information about using the keypad in Menu Mode.</p>
Ready indicator (green)	<p>Indicates when the printer is ready to print.</p> <p>On: The printer is ready to print.</p> <p>Off: The printer is powered off or an error condition exists (the Alarm indicator is on).</p> <p>Flashing: The printer is warming up.</p>
Alarm indicator (orange)	<p>Indicates that an error condition exists. A “beep” sounds when the printer first senses an alarm condition. The message display works in conjunction with the Alarm indicator by showing the type of error condition.</p> <p>For example: 12 PRINTER OPEN</p> <p>The Alarm indicator goes off when the error condition is cleared.</p> <p>See Chapter 6 for information on correcting printer errors.</p>

**Table 3–1 (Cont.): Control Panel Functions**

<b>Item</b>	<b>Function</b>
Data indicator (green)	<p>Indicates the status of the data sent to the printer.</p> <p>On: Data is being printed or is still in the print buffer. If the indicator is on and the printer is not printing, it means the last page needs to be printed. Press <b>On Line</b> and then press <b>Form Feed</b> to print the last page.</p> <p>Off: All data has been printed.</p> <p>Flashing: Data is being received from the host computer.</p> <p><b>NOTE:</b> <i>Data is lost if you power off or reset the printer when the Data indicator is on or is flashing.</i></p>
On Line indicator (green)	<p>Works in conjunction with <b>On Line</b> to indicate when the printer is on line or off line (see <b>On Line</b> in Table 3–3).</p> <p>On: The printer is on line and controlled by the host computer. The host computer can send data to print and commands to control the printer.</p> <p>Off: The printer is off line and cannot receive any data or commands from the host computer. It can only be controlled using the keys on the control panel.</p> <p>Flashing: <b>On Line</b> was pressed while the page was printing. The printer will go off line after the page is printed.</p>
Form Feed indicator (green)	<p>Works in conjunction with <b>Form Feed</b> to indicate when data in the print buffer is being printed or when the command to print is canceled (see <b>Form Feed</b> in Table 3–3).</p> <p>On: Data in the print buffer is being printed.</p> <p>Off: Data is not being printed.</p> <p>Flashing: Command to print is canceled.</p>

## 3.1 Using the Keypad in Keypad Mode

Some keys on the keypad perform a dual function, depending on whether the printer is in Keypad Mode or Menu Mode. In Keypad Mode, the keys perform the primary function labeled on the key, such as Test/Font or Reset.

**NOTE:** *With the exception of On Line, all keys operate only when the printer is off line. A “beep” sounds if any of these keys are pressed when the printer is on line.*

### 3.1.1 Entering Keypad Mode

Use the procedure in Table 3–2 to enter Keypad Mode.

**Table 3–2: Entering Keypad Mode**

Operation	Display Reads
1. Press <span style="border: 1px solid black; padding: 0 2px;">On Line</span> to place the printer off line. — The On Line indicator goes off. — The keypad is now in Keypad Mode.	00 READY

Table 3–3 describes the keypad functions in Keypad Mode.

**Table 3–3: Keypad Functions: Keypad Mode**

Key	Function
<span style="border: 1px solid black; padding: 0 2px;">On Line</span>	Pressing <span style="border: 1px solid black; padding: 0 2px;">On Line</span> alternates the printer between the online mode and offline mode. The mode is indicated by the green light on the key.  On: The printer is on line and controlled by the host computer. The host computer can send data to print, as well as commands to control the printer.  Off: The printer is off line and cannot receive any data or commands from the host computer. It can only be controlled using the keys on the control panel.

**Table 3–3 (Cont.): Keypad Functions: Keypad Mode**

Key	Function
<b>Form Feed</b>	<p><b>Form Feed</b> works in conjunction with the Data indicator. If the Data indicator is on after a file stops printing, it means there is still data in the print buffer. Pressing <b>Form Feed</b> prints the remaining data in the print buffer.</p> <p>When you press <b>Form Feed</b>, the indicator on the key lights to show that the data is being printed. If you press <b>Form Feed</b> again while the data is printing, it stops printing the remaining data and the indicator flashes until the current page exits the printer. Once the page exits the printer, the indicator light remains off. <b>Form Feed</b> can be pressed again to resume printing.</p>
<b>Error Skip</b>	<p>The DEClaser 1100 printer alerts you to certain error conditions by stopping the printer and showing the type of error on the message display. When this happens you may elect to note the problem and then continue printing by pressing <b>Error Skip</b>. Pressing <b>Error Skip</b> bypasses these errors so that printing continues. After you press <b>Error Skip</b>, the printer remains off line. You must press <b>On Line</b> to place the printer back on line and continue printing.</p> <p>Some errors can repeat, such as communications errors or print formatting errors when the printer is receiving additional communication data. When this happens you may need to repeat the Error Skip procedure several times. Refer to Chapter 6 for additional information about errors and corrective actions.</p>
<b>Test/Font</b>	<p><b>Test/Font</b> performs several functions in Keypad Mode:</p> <ul style="list-style-type: none"><li>• Pressing the key once prints Test Print A (see Section 2.9).</li><li>• Pressing and holding the key down for at least three seconds prints the cleaning paper (see Section 7.3).</li><li>• Pressing and holding the key down for at least 12 seconds prints Test Print B (see Section 2.10).</li><li>• Pressing the key twice prints the Font List (see Section 2.11).</li></ul>

**Table 3–3 (Cont.): Keypad Functions: Keypad Mode**

Key	Function
Reset	<p>Pressing <b>Reset</b> for about three seconds performs a soft reset by clearing the data in the print buffer and returning the printer to the ready state (see Section 2.13). The printer operates with the values in operational memory and any values currently stored in RAM (which are loaded into operating memory), when a reset is performed.</p> <p>Other primary functions of <b>Reset</b> are:</p> <ul style="list-style-type: none"><li>• When changing paper tray sizes (see Section 2.5)</li><li>• When changing paper cassette sizes</li><li>• When changing the paper input between tray and cassette</li><li>• To invoke INITIAL menu values (see Table 4–12)</li><li>• To enter and exit Control Representation Mode (see Section 2.12)</li></ul>
Menu	<p>Places the printer in Menu Mode and displays the first menu: <b>FONT/FEED LAYOUT</b>. Refer to Section 4.1 for more information about Menu Mode.</p> <p>Pressing <b>Menu</b> for about four seconds activates Emulation Mode (when an optional emulation cartridge is installed) or Video Mode. Video Mode is used when an external video controller is connected to the printer for custom video data applications. See Section 2.14 for information about selecting Emulation and Video Modes of operation.</p>
Feeder Select	<p><b>Feeder Select</b> has two functions:</p> <p>Pressing <b>Feeder Select</b> momentarily alternates between the paper tray feeding and cassette feeding modes. If an optional paper cassette is not installed, only the paper tray feeding mode is shown on the display.</p> <p>Pressing and holding <b>Feeder Select</b> selects the page format size when the paper tray is used. See Section 2.5 for information about changing the page format size.</p>

## **3.2 Using the Keypad in Menu Mode**

You configure the printer by selecting certain parameters (features and values) while in Menu Mode. You select these parameters using keypad keys that function differently when the printer is in Menu Mode. Chapter 4 covers printer configuration and explains the use of the keypad in Menu Mode (see Section 4.1).

## Chapter 4

# Printer Configuration

---

This chapter describes how to configure the printer by selecting operating parameters that can be stored in the printer's memory. These operating parameters are known as features and values. By selecting the correct operating parameters, you ensure that the printer can communicate properly with the host computer and application software.

You configure the DEClaser 1100 printer by selecting an appropriate set of values from a group of printer setup menus. You make these selections while the printer is in Menu Mode. Once values are selected, you can save them in the appropriate type of memory. Saving features in the proper type of memory allows you to retain most printer values so that the printer has to be configured only once. Figure 4-1 depicts a sample menu from Test Print A showing its features and values.

**Figure 4-1: Sample Menu**

MLO-004856



You can access some menu features by using commands from the host computer; you can select others only from the control panel. This chapter describes how to select features using the control panel. For information about selecting features using commands from the host computer, see the *Digital ANSI-Compliant Printing Protocol Level 3 Programming Reference Manual* and the *Digital ANSI-Compliant Printing Protocol Level 3 Programming Supplement*.

**NOTE:** *The INTERFACE and COMMAND menu features can be configured only from the control panel.*

## 4.1 Entering Menu Mode

You configure the printer by selecting certain parameters (features and values) while in Menu Mode. When the printer is in Menu Mode, the keys labeled with dark gray text and symbols function to select parameters from the menu. Table 4–1 shows how to enter Menu Mode.

**NOTE:** *With the exception of On Line, all keys operate only when the printer is off line.*





**Table 4–1: Entering Menu Mode**

Operation	Display Reads
1. Press <span style="border: 1px solid black; padding: 0 2px;">On Line</span> to place the printer off line. — The On Line indicator goes off.	00 READY
2. Press <span style="border: 1px solid black; padding: 0 2px;">Menu</span> to place the printer in Menu Mode. — The printer is now in Menu Mode and the keys labeled with dark gray text and symbols operate.	<u>F</u> ONT/ <u>F</u> EED LAYOUT

### 4.1.1 Keypad Functions in Menu Mode

Table 4–2 describes the function of the Menu Mode keys. After reading the description of the Menu Mode keys, you may want to try using the keys to better understand their operation. See Section 4.4.1 for an example of how to use the Menu Mode keys to configure the printer.

**Table 4–2: Keypad Functions: Menu Mode**

Key	Function
	Performs two functions: <ul style="list-style-type: none"><li>• Scrolls the menus and features to the right</li><li>• Increases numeric values</li></ul>
	Performs two functions: <ul style="list-style-type: none"><li>• Scrolls the menus and features to the left</li><li>• Decreases numeric values</li></ul>
	Returns the printer to the previous level of operation
 Enter	Performs three functions: <ul style="list-style-type: none"><li>• Advances to the next menu level</li><li>• Invokes the ROM, RAM, and NVRAM functions</li><li>• Invokes the selected value</li></ul>
	Exits Menu Mode and returns printer operation back on line

## 4.2 Reading the Display in Menu Mode

Printer status and operator call messages are shown on the message display in uppercase lettering, preceded by a numerical code. Examples of such messages are 00 READY and 11 PAPER OUT. Menu Mode messages are displayed differently to distinguish among menu selections, feature selections, and value selections.

**NOTE:** *The menu names on the message display are written to accommodate all protocols available on the DEClaser 1100 printer (such as DEC PPL3, PostScript, or CaPSL). Depending on the protocol being used, the menu names that appear on the message display may not read exactly as they do on Test Print A. For example, if you are using Digital's ANSI-Compliant Printing Protocol, the first menu listed on Test Print A is the FEEDER Menu, whereas the first menu listed on the message display is the FONT/FEED Menu.*

## 4.2.1 Displaying Menu and Feature Selections

Menu and feature selections are scrolled to the left or right, and are shown on the message display in groups of 16 characters. This means that in addition to the menu or feature you have selected, other characters are displayed from the next menu or feature. Think of the menu and feature selections as being placed on a scrolling band separated only by a space. The display shows a group of 16 characters from the band and denotes the selection by displaying it first with a cursor below the first letter. See the examples in Figure 4-2.

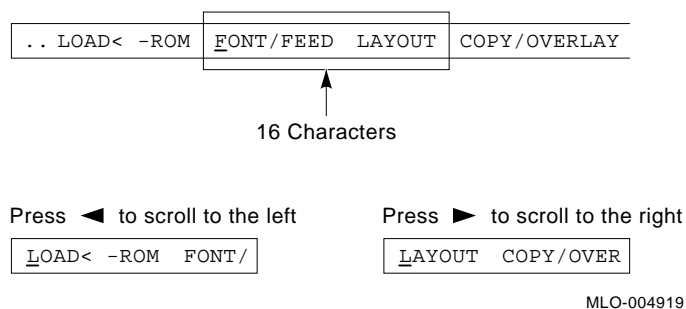

Figure 4-2: Menu Display



This manual shows items from the scrolling menus and features as they appear on the display (uppercase, lowercase, or initial capitals) with the selected item shown in bold type for clarification. For example:

**F**ONT **F**EED LAYOUT or **m**acro paint pape

## 4.2.2 Displaying Menu Values

Menu values are scrolled to the right and left using  and  and are shown on the display with the associated feature, for example:

i/f     RS232C

When you scroll through the values, the currently selected value is always displayed first and is denoted by an equal sign (=) between the feature and value, for example:

i/f     =RS232C

## 4.3 Printer Configuration Memory

Printer configuration uses four types of memory: an operating memory that contains the currently selected values, and three storage memories in which values are stored or saved. These memories are known as ROM (read-only memory), RAM (random-access memory), and NVRAM (nonvolatile random-access memory).

**NOTE:** *All four types of printer configuration memory are separate and distinct from the Free RAM listed on Test Print A. Configuration memory can be accessed only from the menus to set up the operational parameters of the printer.*

You can save new values temporarily in RAM, but they are cleared when the printer is powered off. You can also save new values in NVRAM so that they are not cleared if the printer is reset or powered off. ROM contains the factory default values that can be recalled into the operating memory. Some values can be saved only in RAM or only in NVRAM, while other values can be saved in either type of memory. Test Print A shows the type of memory each menu can use (see Section 2.9).

### 4.3.1 Operating Memory

The printer operates using the currently selected values contained in operating memory. When the printer is powered on, it loads the values stored in NVRAM into operating memory. When you select new values (through escape sequences or from the control panel), they are placed in operating memory and become part of the printer settings that are currently in use. Figure 4-3 shows the operational flow between the different types of memory.

**Figure 4-3: Operating Memory**

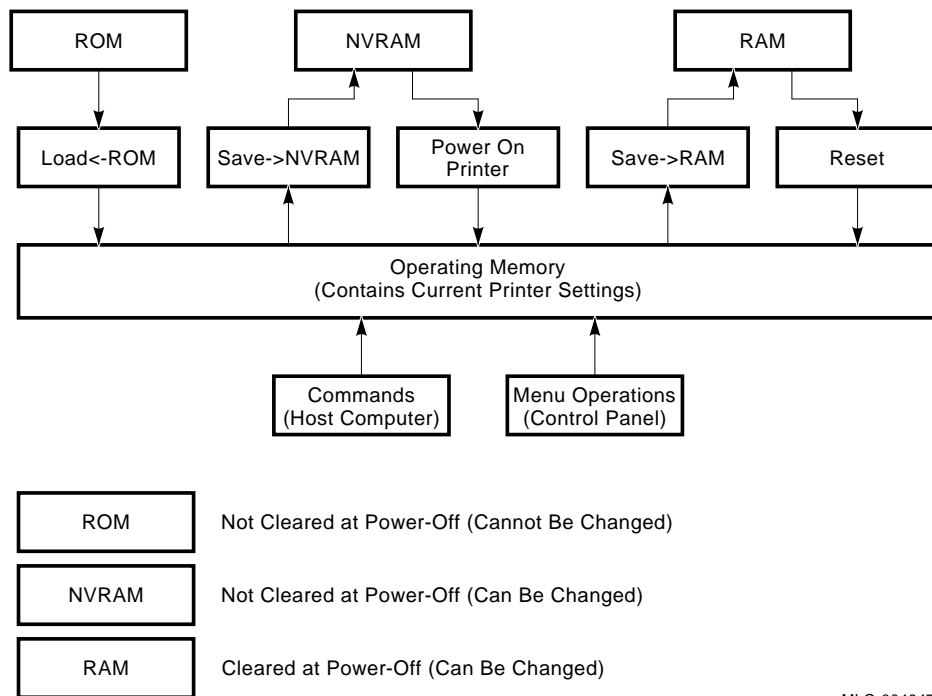

MLO-004947

### 4.3.2 ROM (Read-Only Memory)

ROM contains default values that are set at the factory. They are called default values because they are stored in ROM and cannot be changed. You can load these default values into operating memory while in Menu Mode using the procedure shown in Table 4–3.

**NOTE:** *Default values loaded from ROM are temporary values in operational memory, and are affected if the printer receives a reset command or is powered off. If you want to retain the default values, you must save them in NVRAM (see Section 4.3.3).*

**Table 4–3: Recalling Factory Default Values from ROM**

Operation	Display Reads
1. Press <b>On Line</b> to place the printer off line. — The On Line indicator goes off.	00 READY
2. Press <b>Menu</b> to place the printer in Menu Mode.	<b>FONT/FEED LAYOUT</b>
3. Press <b>&lt;</b> once.	<b>LOAD&lt;-ROM FONT/F</b>
4. Press <b>Enter</b> to load the default values from ROM into operating memory.	OK (momentarily) ↓ <b>LOAD&lt;-ROM FONT/F</b>
5. Press <b>On Line</b> to place the printer on line. — The On Line indicator lights.	00 READY

### 4.3.3 NVRAM (Nonvolatile Random-Access Memory)

The printer can communicate with many systems using the factory default settings in ROM, but you may have to change values to accommodate your particular application or host computer. NVRAM allows those changes to be saved in a nonvolatile memory so that they are available each time you power on the printer. In nonvolatile memory, the selected values are not cleared when the printer is powered off or reset. Selections are saved in NVRAM until you change them. To save values in NVRAM while in Menu Mode, use the procedure shown in Table 4–4.

**Table 4–4: Saving Values in NVRAM**

<b>Operation</b>	<b>Display Reads</b>
1. Press <b>On Line</b> to place the printer off line. — The On Line indicator goes off.	00 READY
2. Press <b>Menu</b> to place the printer in Menu Mode.	<b>FONT/FEED LAYOUT</b>
3. Press <b>&lt;</b> twice.	<b>SAVE-&gt;NVRAM LOAD</b>
4. Press <b>Enter</b> to save the values in NVRAM.	OK (momentarily) ↓ <b>SAVE-&gt;NVRAM LOAD</b>
5. Press <b>On Line</b> to place the printer on line. — The On Line indicator lights.	00 READY



### 4.3.4 RAM (Random-Access Memory)

RAM is a temporary memory area that stores selected values until the printer is powered off. It is useful to store features in RAM when you need to change settings for specific print jobs. To save values in RAM while in Menu Mode, use the procedure in Table 4–5.

**Table 4–5: Saving Values in RAM**

<b>Operation</b>	<b>Display Reads</b>
1. Press <b>[On Line]</b> to place the printer off line.  — The On Line indicator goes off.	00 READY
2. Press <b>[Menu]</b> to place the printer in Menu Mode.	<b>FONT/FEED LAYOUT</b> <b>_</b>
3. Press <b>[&lt;]</b> three times.	<b>SAVE-&gt;RAM SAVE-&gt;</b> <b>_</b>
4. Press <b>[V Enter]</b> to save the values in RAM.	OK (momentarily) ↓ <b>SAVE-&gt;RAM SAVE-&gt;</b> <b>_</b>
5. Press <b>[On Line]</b> to place the printer on line.  — The On Line indicator lights.	00 READY

## 4.4 Operational Flow in Menu Mode

Figure 4–4 illustrates the operational flow to select and change values in Menu Mode. See Section 4.4.1 for an example of selecting values in Menu Mode.

Figure 4-4: Operational Flow Chart

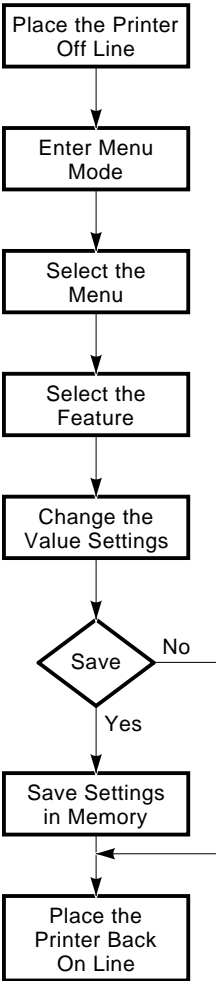

MLO-004946

### 4.4.1 Changing and Saving Values Example Procedure

This section contains an example of how to change and save values in Menu Mode. Use the steps in Table 4–6 to perform the following tasks:

- Enter Menu Mode
- Change the baud rate from 4800 bits/second to 9600 bits/second
- Save the new value in NVRAM
- Exit Menu Mode

#### Before You Begin

This example assumes that the printer is using the factory default values in ROM. You will use Test Print A to verify the changes you make. Print a copy of Test Print A before beginning this example (Section 2.9). Be sure that all printing has stopped and the display reads 00 READY before you make any changes.

**Table 4–6: Changing and Saving Values**

<b>Operation</b>	<b>Display Reads</b>
1. Press <b>[On Line]</b> to place the printer off line.  — The On Line indicator goes off.	00 READY
2. Press <b>[Menu]</b> to place the printer in Menu Mode.	<b><u>F</u>ONT/FEED LAYOUT</b>
3. Press <b>[&gt;]</b> five times to scroll the display to the INTERFACE menu.	<b><u>I</u>NTERFACE SAVE-&gt;</b>
4. Press <b>[v Enter]</b> to enter the INTERFACE menu.	<b><u>i</u>/f baud rsmode</b>
5. Press <b>[&gt;]</b> once to display the baud feature.	<b><u>b</u>aud rsmode dtr</b>

**Table 4–6 (Cont.): Changing and Saving Values**

<b>Operation</b>	<b>Display Reads</b>
6. Press <input type="button" value="Enter"/> to select the baud feature.	baud <u>4</u> 800
7. Press <input type="button" value="Right Arrow"/> once to display the value 9600.	baud <u>9</u> 600
8. Press <input type="button" value="Enter"/> to enter the new value.	baud <u>9</u> 600 (momentarily) ↓ <b>baud</b> rsmode dtr ↓
9. Press <input type="button" value="Up Arrow"/> to return to the menu selections.	<b>INTERFACE</b> SAVE-> ↓
10. Press <input type="button" value="Right Arrow"/> twice to reach the NVRAM SAVE menu.	<b>SAVE-&gt;NVRAM</b> LOAD ↓
11. Press <input type="button" value="Enter"/> to save the baud value in NVRAM.	OK (momentarily) ↓ <b>SAVE-&gt;NVRAM</b> LOAD ↓
12. Press <input type="button" value="On Line"/> to exit the Menu Mode.  — The On Line indicator lights.	00 READY

**Verification**

Verify that the baud rate has been changed by printing a copy of Test Print A (Section 2.9), and comparing the new baud rate with the old baud rate.

## 4.5 Menu Descriptions

This section describes the printer menus, features, and values. See Table 4-7 for a complete listing of all menus and parameters.

**Table 4-7: Menu Mode Features and Values**

Menu	Features	Values
FEEDER	feeder	Tray Cass. <sup>2</sup>
LAYOUT	autoNL	ON <sup>1</sup> OFF
COPY	copy	01 <sup>1</sup> —99
COMMAND	message <sup>3</sup>	English <sup>1</sup> Finnish French German Italian Japan Norway Port. Spanish Swedish Danish Dutch
INITIAL	macro	000 <sup>1</sup> —099
	paint	Partial <sup>1</sup> Full <sup>4</sup> Dual <sup>4</sup>
	paper	Letter <sup>1</sup> A4
INTERFACE	i/f <sup>2</sup>	RS232C <sup>1</sup> CENTRO

<sup>1</sup>Factory default setting.

<sup>2</sup>Available only when an optional cassette is installed.

<sup>3</sup>Cannot be selected using a command from the host. Selectable from the control panel only.

<sup>4</sup>Available only when optional memory is installed.

**Table 4–7 (Cont.): Menu Mode Features and Values**

<b>Menu</b>	<b>Features</b>	<b>Values</b>
	baud <sup>5</sup>	300 600 1200 2400 4800 <sup>1</sup> 9600 19200
	rsmode <sup>5</sup>	8S <sup>1</sup> 8SS 7OS 7ES 7OSS 7ESS 8OS 8ES
	dtr <sup>5</sup>	Fix-H <sup>1</sup> Ready-H
	xon/xoff <sup>5</sup>	ON <sup>1</sup> OFF
	etx/ack <sup>5</sup>	OFF <sup>1</sup> ON

<sup>1</sup>Factory default setting.

<sup>5</sup>Available only when RS232C is selected.

## 4.5.1 FEEDER Menu

The FEEDER menu determines whether paper is fed from the paper tray or from an optional paper cassette. You can also choose the paper feed selection using the **Feeder Select** key on the control panel. See Table 3–3 for more information about using the **Feeder Select** key. Table 4–8 shows the features and values of the FEEDER menu. Settings from this menu are automatically saved in RAM. Menu settings can also be saved in NVRAM.

**Table 4–8: FEEDER Menu Features and Values**

Feature	Values	Description
feeder	Tray <sup>1</sup>	Selects the paper tray to feed paper into the printer.
	Cass. <sup>2</sup>	Selects the paper cassette to automatically feed paper into the printer.

<sup>1</sup>Factory default setting.

<sup>2</sup>Available only when an optional cassette is installed.

## 4.5.2 LAYOUT Menu

The features of the LAYOUT Menu shown in Table 4–9 allow you to set the new line so that print wraps when it reaches the right margin. Settings from this menu can be saved in RAM or NVRAM.

**Table 4–9: LAYOUT Menu Features and Values**

Feature	Values	Description
autoNL	ON <sup>1</sup>	When the print position reaches the right margin, it wraps to the left margin of the next line.
	OFF	When the print position reaches the right margin, it does not move to the next line until the printer receives a carriage return (CR) or line feed (LF) command from the host computer. Data beyond the right margin is lost until the CR or LF command is received.

<sup>1</sup>Factory default setting.

### 4.5.3 COPY Menu

The COPY menu (Table 4–10) determines the number of copies of each page to be printed. You can save this setting only in RAM.

**Table 4–10: COPY Menu Features and Values**

Feature	Values	Description
copy	01 <sup>1</sup> –99	Sets the number of copies of each page to be printed.

<sup>1</sup>Factory default setting.

### 4.5.4 COMMAND Menu

The COMMAND menu (Table 4–11) lets you display messages in your native language. Three types of messages are displayed in the desired language: status, operator call, and error. Service call messages and menu items are displayed only in English.

You cannot select this setting using commands from the host computer. You must select it from the control panel. You can save the setting only in NVRAM.

**Table 4–11: COMMAND Menu Features and Values**

Feature	Values	Description
message	English <sup>1</sup> Finnish French German Italian Japan (Japanese) Norway (Norwegian) Port. (Portuguese) Spanish Swedish Danish Dutch	Displays messages in the selected language.

<sup>1</sup>Factory default setting.



## 4.5.5 INITIAL Menu

The INITIAL menu (Table 4–12) combines the macro, paint, and paper size features. You can save settings from this menu only in NVRAM.

**NOTE:** *Unlike the operation of other menus, a new value selected from the INITIAL menu is not invoked until the printer is reset. After selecting a value, you must perform a soft reset (Section 2.13) to invoke the new value.*

**Table 4–12: INITIAL Menu Features and Values**

Feature	Values	Description
macro	000 <sup>1</sup> –099	Assigns the user preference set, device identification answer, and initialization message (see Section 4.5.5.1).
paint	Partial <sup>1</sup>	Reserves no memory for bitmap pages. Memory is allocated dynamically.
	Full	Directs the printer to allocate memory space for one full bitmap page. The Full setting eliminates complex errors but may slow the printer down if all pages require a full bitmap.  <b>NOTE:</b> <i>A4 and letter-size require at least 1 MB of optional RAM. Legal-size requires 2 MB of optional RAM.</i>
	Dual	Directs the printer to allocate memory space for two full bitmap pages (A4 or letter-size). The Dual setting allows you to print at a more efficient speed for documents that require full-page bitmaps for all pages.  <b>NOTE:</b> <i>This value can be activated only if at least 2 MB of optional RAM is installed in the printer.</i>
paper	Letter	Specifies letter-size (8 ½ in. x 11.0 in.) as the default page format size used in the paper tray when the printer is powered on.
	A4	Specifies A4-size (297 mm x 210 mm) as the default page format size used in the paper tray when the printer is powered on.

---

<sup>1</sup>Factory default setting.

---

#### 4.5.5.1 Macro

The macro feature allows you to select an environment for local compatibility. It assigns the proper user preference character set, enables/disables the initialization message, and specifies the return response (device identification) when a Device Attributes (DA) request is received. The macro feature is slightly different from other menu features because three parameters (user preference character set, initialization message, and device ID) are *added together* to determine the macro value. The user preference, initialization message, and device ID values cannot be selected independently; they must be added together to form the macro value.

The macro feature allows you to choose the user preference character set appropriate for your application or system. Consult the *Digital ANSI-Compliant Printing Protocol Level 3 Programming Reference Manual* for more information about the user preference sets. Table 4–13 lists the user preference character sets and their values.

**Table 4–13: User Preference Character Set**

<b>User Preference Character Set</b>	<b>Value</b>
DEC Supplemental	00 <sup>1</sup>
ISO Latin-1 Supplemental	10
JIS Katakana	20
ISO Latin-Hebrew Supplemental	30
DEC Latin-Hebrew Supplemental	40
DEC 7-Bit Hebrew	50
DEC Technical	60

<sup>1</sup>Factory default setting.

The initialization message is sent to connected devices (when the printer is powered on or reset from the control panel) to indicate that the printer is reinitializing. This feature is designed for use with future applications and should be set to disable at this time. Consult the *Digital ANSI-Compliant Printing Protocol Level 3 Programming Supplement* for additional information about this feature.

**Table 4–14: Initialization Message**

Initialization Message	Value
Disabled	00 <sup>1</sup>
Enabled	05

<sup>1</sup>Factory default setting.

The DEClaser 1100 printer can identify itself as a Digital ANSI-compliant Level 3 printer (PPL3), and therefore can be recognized as such by symbionts and terminal drivers that conform to the Digital ANSI-compliant architecture. This identification is also compatible with Level 2 devices, since all Level 2 sequences are also supported. You can also select an LN03 identification for applications that require the printer to identify itself as an LN03 printer. For example, the DECmate word processing system requires an LN03 device identification. The device identification values are shown in Table 4–15.

**Table 4–15: Device Identification**

Device ID	Value
Digital ANSI-compliant Level 3 device	00 <sup>1</sup>
LN03	01

<sup>1</sup>Factory default setting.

#### 4.5.5.2 Examples Using the Macro Feature

The examples in Table 4–16 demonstrate how to determine the macro value.

**Table 4–16: Macro Feature Examples**

<b>Character Set and Value</b>		<b>Initialization Message and Value</b>		<b>Device ID and Value</b>		<b>Macro Value</b>
DEC 7-Bit Hebrew (50)	+	Not Enabled (00)	+	Level 3 (00)	=	50
DEC Technical (60)	+	Not Enabled (00)	+	Level 3 (00)	=	60
DEC Supplemental (00)	+	Not Enabled (00)	+	LN03 (01)	=	01

#### 4.5.5.3 Paint Mode (paint)

The paint feature instructs the printer to reserve memory space for one or two full bitmap pages, or not to allocate any bitmapped memory space for page printing. Since printer memory is shared with both fonts and page drawings, it is usually desirable to let the printer allocate the memory dynamically, as even full page sixel images will often print in partial paint mode. You should enable the printer to direct the memory allocation mechanism only in the following situations:

- If you are receiving error messages about page complexity—for example, 21 COMPLEX DATA.
- If pages are breaking incorrectly—for example, half the page prints on one sheet and the second half on the next sheet.

See Table 4–12 for a complete description of the paint feature values.

#### 4.5.5.4 Paper Size (paper)

The paper size (paper) feature specifies the page size used in the paper tray when the printer is powered on. Letter-size is the default size for North America, and A4 is the default size for all other areas.

To change the page format size during normal operation, use Feeder Select. See Section 2.5 for information about selecting other format sizes if you are using a different-sized paper in the paper tray.

## 4.5.6 INTERFACE Menu

The correct interface connection is necessary for the printer to communicate properly with the host computer. The DEClaser 1100 printer supports both parallel and serial interface connections. The interface must match the type used by the host computer.

You cannot make selections from the INTERFACE menu using commands from the host computer. All values must be selected from the control panel and can be saved only in NVRAM. Once you make the selections, you should save them in NVRAM so that they will be activated (loaded into operational memory) each time the printer is powered on. The INTERFACE menu features and values are shown in Table 4–17.

**Table 4–17: INTERFACE Menu Features and Values**

Feature	Values	Description
i/f	RS232C <sup>1</sup>	Selects the serial interface to communicate with the host computer. Select this value if your computer uses a serial interface.  When RS232C is selected, you must select values for all the other features in this menu (baud rate, rsmode, and so on).
	CENTRO	Selects the (Centronics) parallel interface to communicate with the host computer. Select this value if your printer uses a parallel interface. When the parallel interface is selected, all other features in the interface menu are not available.
baud <sup>2</sup>	300	Sets the transmit and receive speed the printer uses to communicate with the host computer. The printer speed must match the speed used by the host computer.
	600	
	1200	
	2400	
	4800 <sup>1</sup>	
	9600	
rsmode <sup>2</sup>	8S <sup>1</sup>	8 data bits No parity check 1 stop bit
	8ES	8 data bits Even parity check 1 stop bit

<sup>1</sup>Factory default setting.

<sup>2</sup>Available only when RS232C is selected.

**Table 4–17 (Cont.): INTERFACE Menu Features and Values**

<b>Feature</b>	<b>Values</b>	<b>Description</b>
	8OS	8 data bits Odd parity check 1 stop bit
	7ESS	7 data bits Even parity check 2 stop bits
	7OSS	7 data bits Odd parity check 2 stop bits
	7ES	7 data bits Even parity check 1 stop bit
	7OS	7 data bits Odd parity check 1 stop bit
	8SS	8 data bits No parity check 2 stop bits
dtr <sup>2</sup>	Fix-H <sup>1</sup>	Sets the data terminal ready (DTR) line to a fixed high signal.
	Ready-H	Sets the DTR line to a high signal when the printer is ready to receive data.
xon/xoff <sup>2</sup>	ON <sup>1</sup>	Enables xon/xoff buffer overflow control.
	OFF	Disables xon/xoff buffer overflow control.
etx/ack <sup>2</sup>	OFF <sup>1</sup>	Disables etx/ack buffer overflow control.
	ON	Enables etx/ack buffer overflow control.

**NOTE:** *Etx/ack is not supported on Digital systems.*

<sup>1</sup>Factory default setting.

<sup>2</sup>Available only when RS232C is selected.

#### **4.5.6.1 Interface Selection (i/f)**

The interface selection (i/f) feature selects the type of interface used to communicate with the host computer. It must match the interface used by the host computer, either serial or parallel.

When you select the parallel (CENTRO) interface, you cannot select any other settings in the INTERFACE menu. The other features in this menu apply only to the serial interface and are not displayed when you select the parallel interface.

When you select the serial interface, you must also select certain other values in the INTERFACE menu in order to match the features of the host computer. The additional features are described next.

#### **4.5.6.2 Baud Rate (baud)**

The baud rate (baud) feature sets the transmit and receive speed the printer uses to communicate with the host computer. The printer speed must match the speed used by the host computer.

#### **4.5.6.3 RS232C Data Format (rsmode)**

The RS232C data format (rsmode) feature determines the data format the printer uses to communicate with the host computer. The first part of the value (7 or 8) is the number of data bits the printer expects to see in each character it receives. The second part of the value is the type of parity (checking) bit the printer looks for in each character. A parity check is a method used to detect errors when data is sent over a communications line. Some systems use an odd parity bit to detect errors, while other systems use an even parity bit. Some systems use no parity bit at all. The third part of rsmode is the number of stop bits. Some systems use one stop bit while other systems require two. The format for the data bits, parity bit, and stop bit(s) must match the format of the host computer in order for the printer and the host to communicate.

#### **4.5.6.4 Data Terminal Ready (dtr)**

The data terminal ready (dtr) feature uses hardware to regulate the flow of data to the input buffer of the printer. The printer transmits a signal to the DTR line of the serial port when it is ready to receive data. This is sometimes referred to as the hardware handshaking protocol.

For Digital systems, the dtr feature should always be set to the fixed high value. When the DTR signal is fixed high (Fix-H), it indicates to the system that the printer is “present.”



#### **4.5.6.5 Buffer Control (xon/xoff)**

The buffer control (xon/xoff) feature uses software to regulate the flow of data to the input buffer of the printer. It is sometimes referred to as software handshaking protocol, a method the printer and the host computer use to exchange on/off signals. These signals prevent the input buffer from overflowing with data. If the input buffer becomes full and handshaking is not enabled, the overflowing data will be lost. Xon/xoff must be enabled in systems that use this software handshaking protocol to prevent the loss of data.

#### **4.5.6.6 End of Text/Acknowledge (etx/ack)**

The end of text/acknowledge (etx/ack) feature is another type of handshaking protocol which is used on some systems to prevent data overflow. The etx/ack feature also uses software to regulate the flow of data to the input buffer by exchanging signals with the host computer. It is recommended that this feature be enabled by systems that support etx/ack to prevent the loss of data.

**NOTE:** *The etx/ack feature is not supported on Digital systems. Use xon/xoff if you have a Digital system.*

## Chapter 5

# Print Media

---

This chapter describes the print media that are appropriate for use with the DEClaser 1100 printer. The types of print media described in this chapter are paper, labels, transparencies, and envelopes.

The DEClaser 1100 printer produces excellent print quality using electrophotographic laser technology. The laser printing process differs greatly from that of a conventional impact printer, and this is why paper selection is particularly important. Because toner is bonded to the paper as it passes through the heat and pressure rollers of the fixing unit, the paper must be able to withstand high amounts of heat and pressure.

**CAUTION:** *When selecting paper or other print media, always print test samples on the paper you want to use. This is particularly important when you are printing on chemically treated or coated paper, such as preprinted forms or colored paper. The inks and pigments used on these papers must also be able to withstand the high heat and pressure of the fixing unit. Be sure to consider the heat limitations of transparencies and the glues used on envelopes and labels. Always select print media according to the instructions and specifications in this chapter. For a complete listing of recommended print media and ordering information, see Appendix B.*

Print quality can also deteriorate if paper is not stored properly. Read Section 5.5 for complete information about storing paper.

For additional information about print media, consult the *Digital Laser Printers Guide to Paper and Other Media*, available from DECdirect (see the Associated Documentation section in the Preface for a listing of documentation).

## 5.1 Paper Specifications

This section contains information on the sizes and specifications of plain paper that can be used with the DEClaser 1100 printer.

The paper tray can feed paper sizes ranging from 97 mm x 148 mm to 216 mm x 356 mm. Table 5-1 lists the paper sizes that can be used with the optional paper cassettes for the printer.

**Table 5-1: Cassette Feed Paper Sizes**

Paper Size	Dimensions
A4	210 mm x 297 mm
Executive	7 ¼ in. x 10 ½ in.
Letter	8 ½ in. x 11 in.
Legal	8 ½ in. x 14 in.

### Envelope Sizes

The DEClaser 1100 printer can accept the following sizes of envelopes:

Minimum: 97 mm x 148 mm (3.8 in. x 5.8 in.)

Maximum: 216 mm x 356 mm (8 ½ in. x 14 in.)

Table 5-2 lists paper specifications for the DEClaser 1100 printer.

**Table 5-2: Paper Specifications**

Catagory	Specification
Paper weight: plain paper	60 g/m <sup>2</sup> to 105 g/m <sup>2</sup> basis weight (16 lb. to 28 lb.)
Paper weight: envelopes	60 g/m <sup>2</sup> to 90 g/m <sup>2</sup> basis weight (16 lb. to 24 lb.)
Moisture content	5% to 8%
Smoothness	100-300 Sheffield
Brightness	84% minimum recommended
Heat tolerance	150°C (302°F) for 0.1 second
Cotton (rag) content	25% maximum

### 5.1.1 Special Considerations When Printing on Paper

Because of the way laser printers print and bond toner to the paper, you must observe some special requirements with certain types of papers:

- Do not use preprinted papers that do not meet the specifications for heat tolerance. The ink from some preprinted papers, such as those with a company letterhead, can cause smearing and in some extreme cases could damage the printer.
- Do not use colored papers in which the color is applied as a coating to the surface.
- Do not use thermal papers.
- Do not use carbon papers.

**NOTE:** See *Appendix B* for acceptable papers available from Digital.

## 5.2 Envelope Specifications

Envelopes must meet the same specifications as paper (see Table 5–2). In addition, the following types of envelopes cannot be used with the printer:

- Envelopes with sealing flaps that are open

MLO-004859

- Envelopes with sealing flaps at the leading and trailing edges

MLO-004860

- Envelopes with three or more layers of paper at the leading and trailing edges

MLO-004861...Actual pica height is 15

- Envelopes that have transparent windows

MLO-004862

- Envelopes that have clasps, snaps, or strings

MLO-004863...Actual pica height is 14.5

### 5.2.1 Special Considerations When Printing on Envelopes

Observe the following requirements when printing on envelopes:

- Do not load more than five envelopes in the paper tray.
- Envelopes can be printed only on the front side.
- Since you need to print addresses in a particular area on envelopes, you must give the printer the proper print coordinates to print the addresses. See Section 2.6 for more information about printing on envelopes.
- Use the front output (faceup) tray.
- Printing in the 15 mm (3/5 in.) border around the envelope may cause print quality problems with some types of envelopes. For best print quality, do not print in this border.

MLO-005978

**NOTE:** See Appendix B for acceptable envelopes available from Digital.



## 5.3 Transparency Specifications

Table 5–3 and Table 5–4 contain information on the sizes and specifications of transparencies that can be used with the DEClaser 1100 printer.

**Table 5–3: Transparency Sizes**

Transparency Size	Dimensions
A4	210 mm x 297 mm
Letter	8 ½ in. x 11 in.

**Table 5–4: Transparency Specifications**

Category	Specification
Transparency weight: front output tray only	135 g/m <sup>2</sup> to 150 g/m <sup>2</sup> basis weight
Thickness	0.095 mm to 0.115 mm
Heat tolerance	150°C (302°F) for 0.1 second

### 5.3.1 Special Considerations When Printing on Transparencies

Observe the following requirements when printing on transparencies:

- Transparencies are usually fed from the paper tray. If you are feeding transparencies from a cassette, be sure they are high-quality transparencies and meet the specifications listed in Table 5–4.
- Fan the transparencies before loading them to prevent jams.
- Use the front output (faceup) tray only.
- Remove transparencies from the output tray as each one is printed to prevent them from sticking to each other.

**NOTE:** See Appendix B for acceptable transparencies available from Digital.

## 5.4 Label Specifications

A label consists of a face sheet, an adhesive sheet, and a carrier sheet. The face sheet (or printing surface) is usually composed of photocopying paper and should meet the same specifications for paper as described in Table 5-2. The carrier sheet and adhesive used for the labels must also be able to meet the heat tolerance specification of 150°C (302°F) for at least 0.1 second.

**CAUTION:** *Exposed adhesive on labels can cause damage to the printer. An easy way to test for adhesive that may be exposed is to press a plain piece of paper on top of the sheet of labels. If the paper sticks to the labels, you should not use those labels.*

Figure 5-1 shows the types of labels that are unacceptable.

### Figure 5-1: Unacceptable Labels

MLO-005991

### 5.4.1 Special Considerations When Printing on Labels

Observe the following requirements when printing on labels:

- Labels are usually fed from the paper tray. If you are feeding labels from a cassette, be sure they are high-quality labels that meet the specifications listed in Table 5-2.
- Be sure that the carrier sheet is not exposed.
- Be sure that no adhesive is exposed.
- Use the front output (faceup) tray only.

**NOTE:** See Appendix B for acceptable labels available from Digital.

## 5.5 Paper Handling and Storage

Although you may be using paper that meets all specifications, improper handling and storage may affect the quality of the paper and the performance of the printer. Improper storage and handling can cause paper jams, misfeeding, and other printer performance problems.

Follow the recommendations in this section on paper storage and handling to reduce the possibility of printer jams and misfeeds.

### 5.5.1 Paper Handling

Observe the following requirements when handling paper:

- Load paper cassettes to their proper capacity rather than adding small amounts at a time. Loading small amounts of paper can cause jams because of air pockets created between small stacks of paper.
- When you unwrap a new package of paper, discard the top and bottom sheets, as they tend to absorb the most humidity from the surrounding environment.
- Sudden temperature or humidity changes can cause paper curl, leading to misfeeds and paper jams. If you bring paper from a storage location that differs greatly in temperature or humidity, leave the paper (unopened) for a day to allow it to adjust to the printer room environment.
- Check to see that the paper is loaded with the correct side up. Some packages of paper have an arrow on the label that points in the direction of the top side of the paper. Load paper with this top side up.

If there is no arrow on the label, check the paper for curl. If an excessive amount of curl is present, fan the paper in the opposite direction of the curl to remove as much of the curl as possible.

- Follow the instructions in Chapter 2 to properly load paper.

### 5.5.2 Paper Storage

Observe the following requirements when storing paper:

- Always store unused paper in its original wrapping. The wrapping protects the paper against humidity.
- Do not store paper directly on the floor, as floors are generally humid.
- Lay paper on a flat surface to prevent in-ream paper curl.

## Chapter 6

# Troubleshooting

---

This chapter helps you to quickly locate most problems that may occur with the printer. It discusses the following topics:

- Error skip procedure (Section 6.1)
- Printer status messages (Section 6.2)
- Operator call messages (Section 6.3)
- Software error messages (Section 6.4)
- Service call messages (Section 6.5)
- Common operating problems (Section 6.6)
- Paper jams (Section 6.7)

Most problems are identified on the message display when they occur. The corrective action to take is listed in the appropriate table, as follows:

- Printer Status Messages, Table 6-2
- Operator Call Messages, Table 6-3
- Software Error Messages, Table 6-4
- Common Operating Problems, Table 6-5

## 6.1 Error Skip Procedure

The DEClaser 1100 printer alerts you to error conditions by stopping the printer, placing it off line, and displaying the type of error on the control panel. Some error conditions cannot be cleared using the error skip procedure. For example, 12 PRINTER OPEN needs to be corrected immediately before printing can continue. You can acknowledge other types of errors and still continue printing by pressing **Error Skip**. When these types of errors occur, you may elect to take the long-term corrective action (for example, adding RAM or reassigning memory) at another time. Use the procedure in Table 6-1 to acknowledge the error condition and continue printing.

**Table 6-1: Error Skip Procedure**

<b>Operation</b>	<b>Display Reads</b>
1. Press <b>Error Skip</b> . — The Alarm indicator shuts off. — The error condition clears.	00 READY
2. Press <b>On Line</b> to place the printer back on line. — The On Line indicator lights. — Printing continues.	00 READY

Some communication or formatting errors may repeat when the printer is receiving additional communications data. When this happens you may need to repeat the error skip procedure several times.

## 6.2 Printer Status Messages

Printer status messages are displayed to show the printer's current operating condition (see Table 6–2). This status information lets you know if the printer is performing a task or is ready to receive another job. Status messages are displayed whether the printer is on line or off line.

**Table 6–2: Printer Status Messages**

<b>Message</b>	<b>Meaning</b>
00 READY DEC	The printer is ready to operate in DEC PPL3 Mode. The ready condition can exist whether the printer is on line or off line.
*00 EX READY	The printer is in video mode and ready to operate. To select another mode of operation see Section 2.14.
01 TEST PRINT B	Test Print B is being printed (Section 2.10).
02 WARMING UP	The printer has not reached operating temperature. Printing cannot be performed while the printer is warming up.
03 RESET	The printer is being reset (Section 2.13).
04 TEST STOP	Test printing has stopped.
05 TEST PRINT A	Test Print A is being printed (Section 2.9).
06 FONT LIST A	Font List A is being printed (Section 2.11).
08 CLEANING PAP.	The cleaning paper is being printed.
08 SET THE PAPER	The printer is ready to have the cleaning paper loaded (printed side up) into the paper tray.
08 CLEANING	The cleaning paper is being run through the printer to clean the fixing assembly.

## 6.3 Operator Call Messages

Operator call messages appear if a problem with the printer requires operator intervention, such as adding paper or closing the printer cover. You should check the online/offline status of the printer after correcting a problem; you may have to place the printer back on line by pressing [On Line](#). Table 6–3 lists the operator call messages.

**NOTE:** *The operator call message number flashes when it is displayed.*

**Table 6–3: Operator Call Messages**

Message	Meaning	Corrective Action
10 CHECK PAPER <sup>1</sup>	Paper is not properly loaded in the cassette.	Reload paper in the paper cassette.
*10 EX NOT READY	External video connector is initializing.	Wait until initialization is complete (*00 EX READY).
11 TRAY PAPER xx	There is no xx-size paper in the paper tray.	Add xx-size paper to the paper tray (Section 2.4).
11 PAPER OUT <sup>1</sup>	There is no paper in the paper cassette.	Add paper to the paper cassette.
	There is no paper cassette installed in the printer, or the cassette is not installed securely.	Install the paper cassette securely in the printer.
12 PRINTER OPEN	The front cover of the printer is open.	Close the front cover.
	The fixing assembly cover is open.	Close the fixing assembly cover.
	The EP-L cartridge is not installed.	Install the EP-L cartridge (Section 7.2).
13 PAPER JAM	Paper is jammed inside the printer.	Remove jammed paper from the printer (Section 6.7).
PC LOAD A4	Request for an A4-size paper cassette.	Install an A4-size paper cassette into the printer.
	The printer was not reset after the cassette size was changed.	Reset the printer (Section 2.13).

---

<sup>1</sup>This message is displayed only when an optional paper cassette is installed.



**Table 6–3 (Cont.): Operator Call Messages**

<b>Message</b>	<b>Meaning</b>	<b>Corrective Action</b>
PC LOAD LETTER	Request for a letter-size paper cassette.	Install a letter-size paper cassette into the printer.
	The printer was not reset after the cassette size was changed.	Reset the printer (Section 2.13).
PC LOAD LEGAL	Request for a legal-size paper cassette.	Install a legal-size paper cassette into the printer.
	The printer was not reset after the cassette size was changed.	Reset the printer (Section 2.13).
PC LOAD EXEC	Request for an executive-size paper cassette.	Install an executive-size paper cassette into the printer.
	The printer was not reset after the cassette size was changed.	Reset the printer (Section 2.13).
PC LOAD PAPER nn	Request for the envelope cassette.	Install the envelope cassette into the printer.
	The printer was not reset after the cassette size was changed.	Reset the printer (Section 2.13).

## 6.4 Software Error Messages

You can correct many software errors by adding additional memory, reassigning memory, or by selecting the proper interface parameter. Table 6–4 describes the corrective action to take when a software error occurs.

**Table 6–4: Software Error Messages**

Message	Meaning	Corrective Action
20 PAGE FULL	The page buffer is overflowing with data.	Clear fonts from memory after each job.  Assign one or two full-page bitmap areas in memory to handle the complex data (Section 4.5.5.3).  Add additional RAM.
21 COMPLEX DATA	There is complex print data that the printer cannot handle.	Assign one or two full-page bitmap areas in memory to handle the complex data (Section 4.5.5.3).
22 LINE ERROR	The receiving buffer is overflowing with data.	Enable a handshaking protocol to regulate data flow (see Section 4.5.6.4, Section 4.5.6.5, and Section 4.5.6.6).  Ensure that the host, the printer, and any other devices that are connected (such as printservers) all have the same type of handshaking protocol enabled.
23 MEMORY FULL	Memory cannot accept additional downline loading of fonts into memory.	Clear fonts from memory after each job.  Reallocate less bitmap page memory space (Section 4.5.5.3).  Add additional RAM.
24 FULLPAINT REJ	Full paint mode is not allowed due to lack of memory space.  Page format size does not match specified memory reservation.	Clear fonts from memory after each job.  Add additional RAM.  Change paper format size (see Section 2.5) or specify matching memory reservation (see Table 4–12).

**Table 6–4 (Cont.): Software Error Messages**

<b>Message</b>	<b>Meaning</b>	<b>Corrective Action</b>
26 MEMORY FULL	RAM memory space is full.	Clear fonts from memory after each job. Add additional RAM.
40 LINE ERROR	An error has occurred in the communication circuit.	Check the interface parameters (Section 4.5.6). Check the integrity of lines; be sure cables are properly shielded and all ground screws are in place.
41 PRINT CHECK	A misprint has occurred.	Perform the error skip procedure (Section 6.1).
FE FONT REMOVAL	A font cartridge has been removed from before turning the printer off.	Power off the printer and install the font cartridge before powering the printer back on. <b>CAUTION:</b> <i>To prevent damage to the font cartridge or the printer, always turn the printer off before removing a font cartridge.</i> If you do not want to use the font cartridge, power off the printer and wait at least two seconds, then power it back on.
FF FONT FULL	The font dictionary is full.	Reduce the number of fonts in memory. Clear fonts from memory after each job. Add additional RAM.

## 6.5 Service Call Messages

Service call messages indicate that the printer requires servicing by a qualified Digital Customer Services engineer (see Chapter 8 for service information). Service messages are displayed as XX SERVICE (where XX equals a number from 50 through 99).

**NOTE:** *Before calling for service, try to clear the error message by powering the printer off. After a few seconds, power the printer on. If the error message is still displayed, power the printer off and call for service.*

## 6.6 Common Operating Problems

Table 6–5 lists common operating problems and their possible solutions. All corrective actions should be followed in the order in which they are listed. Check the table to solve printer problems before calling for service.

**NOTE:** *Since many problems with print quality could be caused by a faulty component in the EP-L cartridge, it is recommended that you keep a spare cartridge as a replacement. If you are experiencing a problem with print quality that is not listed in the troubleshooting table, you can replace the EP-L cartridge to see if it solves the problem before calling for service.*

**CAUTION:** *The rollers in the fixing assembly may be hot. Be careful when checking for problems inside the printer.*

**Table 6–5: Common Operating Problems**

<b>Problem</b>	<b>Possible Cause</b>	<b>Corrective Action</b>
<b>NO POWER</b>		
The printer does not power on when you set the power switch to the ON position.	The power source is defective.	Make sure the power cord is plugged into the wall outlet. Check that there is power at the wall outlet by plugging in a lamp to see if it lights. If the lamp does not light, call your building maintenance services to check the circuit supplying power to that outlet.
	The power cord is not connected or is damaged.	Check the power cord for damage and secure connections at the printer and at the wall outlet.
<b>NO PRINTOUT</b>		
The message display reads 00 READY.	The printer is in the offline state.	Press <b>On Line</b> to place the printer on line.
	Interface selection, baud rate, or data bits/parity features do not match the host settings.	See Section 4.5.6 for information about these features.
	The interface cable to the host is not connected properly.	Check the cable connections at the printer and at the host computer.
The message display reads 00 READY. The Data indicator is on.	Data is still in the print buffer.	Press <b>On Line</b> to place the printer off line and then press <b>Form Feed</b> to print the remaining data. Be sure to press <b>On Line</b> to place the printer back on line after the last page is printed.

**Table 6–5 (Cont.): Common Operating Problems**

<b>Problem</b>	<b>Possible Cause</b>	<b>Corrective Action</b>
<b>POOR PRINTING</b>		
Large amounts of vertical fade and/or white streaks are on the page.	Toner is not being dispersed evenly.	Remove the EP-L cartridge from the printer and gently rock it several times to redistribute toner.  Replace the EP-L cartridge (Section 7.2).
Printing is too light.	The print density setting is incorrect.	Adjust the print density setting (Section 2.8).
	The EP-L cartridge is out of toner.	Replace the EP-L cartridge (Section 7.2).
Printing is too dark.	The print density setting is incorrect.	Adjust the print density setting (Section 2.8).
The page printed blank.	The toner seal was not completely removed from the EP-L cartridge.	Remove the toner seal completely from the EP-L cartridge (Section 7.2).
	The EP-L cartridge is faulty.	Replace the EP-L cartridge (Section 7.2).
The page printed black.	The EP-L cartridge is not installed properly.	Remove and reinstall the EP-L cartridge.
	The EP-L cartridge is faulty.	Replace the EP-L cartridge (Section 7.2).
Stray toner is fused to the paper.	The fixing assembly is dirty.	Clean the fixing assembly (Section 7.3).
	The cleaning mechanism in the EP-L cartridge is not working properly.	Replace the EP-L cartridge (Section 7.2).
The overall print quality is poor.	The print medium is not the recommended type.	See Chapter 5 for print media specifications.

**Table 6–5 (Cont.): Common Operating Problems**

<b>Problem</b>	<b>Possible Cause</b>	<b>Corrective Action</b>
<b>MISCELLANEOUS</b>		
A paper jam occurred.	There is an obstruction in the paper path.	See Section 6.7 for instructions on clearing paper jams.
Print lines overlap.	The vertical pitch setting is incorrect.	Correct the vertical pitch setting in your application program.
The print is skewed.	The print medium is not the recommended type.	See Chapter 5 for print media specifications.
	Paper is not loaded in the paper tray properly.	Reload paper in the paper tray (Section 2.4).
Printed pages have garbled characters.	Incorrect printer features were selected.	Check to see that the baud rate and data bits/parity format match the host computer settings (Section 4.5.6).
Envelopes are fogged lightly with toner.	The print density setting is too light.	Increase the print density setting (Section 2.8).

## 6.7 Paper Jams

Paper jams are typically caused by:

- Damaged paper (torn or folded)
- Improperly stored paper (excessive paper curl or humidity)
- Paper that does not meet specifications (incorrect weight or heat tolerance)
- Paper that is improperly loaded in the tray (not aligned properly)

To reduce the chance of paper jams, you should follow the instructions for proper paper selection, storage, and loading as outlined in Chapter 5. To ensure that you are loading paper in the tray properly, see Section 2.4.1 for the correct procedure.

The following occurs when there is a paper jam in the printer:

- The printer stops printing and goes off line.
- The error message 13 PAPER JAM appears on the control panel.
- The Alarm indicator lights.

Most paper jams occur in the areas shown in Figure 6–1.



**Figure 6–1: Paper Jam Areas**

MLO-005979

After clearing a paper jam, reset the printer by closing the front cover. Closing the cover clears the error condition, but the printer must be placed back on line. After the cover is closed, press **On Line** to place the printer back on line. When a paper jam is cleared and printing is resumed, the DEClaser 1100 printer automatically reprints the page that jammed.

### 6.7.1 Clearing Printer Paper Jams

Use the following procedures to clear all types of paper jams from the printer.

**WARNING:** *The rollers in the fixing assembly may be hot. Be careful when accessing this area.*

1. Remove the front output tray (if it is installed) by squeezing it slightly to release its pegs from the printer slots.

MLO-005980

2. Remove any paper remaining in the paper tray and close the extension tray.

MLO-005981

3. Press the front cover release button up and open the front cover.
  - The Alarm indicator lights.
  - The display reads 12 PRINTER OPEN.
  - The printer goes off line.

MLO-005808

4. Remove any jammed paper from the pickup area by pulling the paper out in the direction of the arrow.
  - ✓ If all jammed paper has been cleared, go to step 7. If there was no paper jammed in the pickup area, go to step 6.

MLO-005982

5. Remove any jammed paper from the fixing assembly by pulling the paper out in the direction of the arrow.
  - ✓ If all jammed paper has been cleared, go to step 7. If there was no paper jammed in the fixing assembly, continue with the next step.

MLO-005983

6. Open the paper access cover and remove any jammed paper by pulling it straight up.
  - ✓ Close the paper access cover.

MLO-005984

7. Close the front cover.
  - The printer initializes (recycles).
  - The Alarm and Data indicators shut off.
  - The message display reads 00 READY.

MLO-005814



8. Open the fixing assembly access cover and remove any remaining pieces of paper that may be caught in the fixing assembly.

**WARNING:** *The rollers in the fixing assembly may be hot. Be careful when accessing this area.*

MLO-005985

9. Reload paper and press On Line to resume printing.
  - The jammed page is reprinted.

### **6.7.2 Clearing Cassette Paper Jams**

Use the following procedure to clear jammed paper from the paper cassette.

1. Pull out the paper cassette and remove the jammed paper.
  - ✓ Remove all the paper from the cassette and reload the cassette.
  - ✓ Be sure there are no damaged sheets reloaded into the cassette.

MLO-005986

## Chapter 7

# Maintenance

---

To obtain optimum performance from the DEClaser 1100 printer, you must perform the prescribed care and maintenance as outlined in this chapter. This chapter describes how to properly maintain the printer and covers the following topics:

- Extending EP-L cartridge life (Section 7.1)
- Replacing the EP-L cartridge (Section 7.2)
- Cleaning the fixing assembly (Section 7.3)
- Cleaning the printer (Section 7.4)

## 7.1 Extending EP-L Cartridge Life

Each EP-L cartridge contains a photosensitive drum, cleaning mechanism, charging roller, and toner, assuring you of optimum print quality throughout the life of the cartridge. When the cartridge runs out of toner, you replace it with a new one.

**CAUTION:** *The use of refilled EP-L cartridges is not recommended and may have an adverse effect on print quality. Consumables available through Digital, or recommended by Digital, should be used with Digital laser printers.*

A new EP-L cartridge lasts for approximately 3,300 pages (A4 or letter-size) of typical word processing text at 4% coverage with the default print density setting. However, the cartridge life will vary depending on the amount of toner used for your particular application and the print density setting. If your average page contains more “white space” than the typical 4% coverage, the cartridge life will be longer. A lighter density setting reduces the amount of toner used. You can significantly extend the life of an EP-L cartridge by adjusting the print density to the lightest setting that gives you acceptable print quality. See Section 2.8 for information about setting the print density.

The following rules apply to cartridge care:

- For best print quality, always use the EP-L cartridge before the expiration date printed on the box.
- Do not remove the cartridge from its aluminum packing bag until you are ready to use it.
- Store the cartridge in an area where the average temperature is 0° to 35°C (32° to 95°F).
- Do not leave the cartridge exposed to direct sunlight.
- Do not stand the cartridge on its end or lay it upside down.
- Do not attempt to disassemble the cartridge or open the light blocking shutters. Exposing the cartridge to light may result in poor print quality.
- Do not open the drum protection shutter. Touching the photosensitive drum will damage it and cause problems with print quality.
- Keep the cartridge away from cathode ray tubes (CRTs), disk drives, and floppy disks. The magnet in the cartridge may affect the operation of these devices.

## 7.2 Replacing the EP-L Cartridge

When the print quality becomes uneven, or printing is too light, it means that the printer is either running out of toner, or the toner is not being distributed evenly. Before replacing the EP-L cartridge, make sure that the toner is really depleted. Rock the cartridge back and forth gently to redistribute any remaining toner as shown in Figure 7-1.

**Figure 7-1: Rocking the EP-L Cartridge**

MLO-005811

Reinstall the cartridge in the printer and try printing. If the print quality is acceptable, the cartridge will last for a while longer. If the print quality is not acceptable, you need to replace the EP-L cartridge.

To replace the EP-L cartridge, follow the instructions on the cartridge box or use the following procedure.

1. Be sure the printer is not printing and the display reads 00 READY.
2. Lift up the release button to open the front cover.

MLO-005808

3. Remove the old EP-L cartridge from the printer by pulling it out by its tab.
  - The Alarm indicator lights.
  - The display reads 12 PRINTER OPEN.
  - The printer goes off line.
  - ✓ If the cartridge is difficult to remove, push in the green lever on the right side of the printer to disengage the cartridge, and then remove it.
  - ✓ Discard the cartridge.

MLO-005989

4. Remove the new EP-L cartridge from its package and rock it from end to end five or six times to distribute the toner evenly.

**NOTE:** *Do not shake the cartridge vigorously.*

MLO-005811



5. Remove the sealing tape by holding the cartridge on a flat, stable surface, and gently pulling the orange tab straight out of the cartridge.

**CAUTION:** *Pull the tab straight out of the cartridge. Pulling the tab at an angle can snap or cut the tape.*

- The sealing tape is about 457 mm (18 in.) long and may have toner on it. If you get toner on your hands or clothing, wash them with cold water and soap.
- ✓ Discard the sealing tape.

MLO-005812

6. Insert the EP-L cartridge by aligning the arrow on the cartridge with the ∇ mark on the printer, and gently push the cartridge in until it stops.

MLO-005813

7. Slowly close the front cover.
  - The display reads 02 WARMING UP (momentarily).
  - The display reads 00 READY.

**NOTE:** *If the EP-L cartridge is not pushed in completely, the front cover will not close.*

MLO-005814

8. Go to Section 7.3 and perform the fixing assembly cleaning procedure.

### 7.3 Cleaning the Fixing Assembly

Cleaning the fixing assembly removes the excessive toner from the heat and pressure rollers. You should clean the fixing assembly each time you replace the EP-L cartridge, and when you notice stray toner or smudges being fused to the paper. By keeping the fixing assembly clean, you reduce the chance of paper jamming in that area.

The cleaning procedure uses a special cleaning paper generated by the printer.

**NOTE:** *Always use plain white paper to generate the cleaning paper. It can be A4-size, letter-size, or legal-size paper.*

Use the following procedure to clean the fixing assembly.

1. Be sure the printer is not printing and the display reads 00 READY.
2. Press **[On Line]** to place the printer off line.
  - The On Line indicator shuts off.
3. Press and hold down **[Test/Font]** until 08 CLEANING PAP. is displayed.
  - The display reads 05 TEST PRINT A (momentarily).
  - The display reads 08 CLEANING PAP.
  - The cleaning paper is printed.
  - The display reads 08 SET THE PAPER.

4. Insert the printed cleaning paper into the paper tray with the printed side facing up.

MLO-005988

5. Press **Test/Font** to run the cleaning paper through the printer.
  - The display reads 08 CLEANING.
  - The cleaning paper exits to the output tray, indicating that the fixing assembly is clean.
  - The display reads 00 READY.
  - ✓ Discard the cleaning paper.
6. Press **On Line** to place the printer on line.
  - The On Line indicator lights.

## 7.4 Cleaning the Printer

If the external surfaces of the printer become dirty, you can clean them using a clean, damp cloth.

**CAUTION:** *To prevent possible damage to the external surfaces of the printer, do not use cleaners or solvents. Use a clean cloth dampened with water only.*

MLO-005987

## Chapter 8

# Service

---

If you cannot correct a problem with the DEClaser 1100 printer, request servicing by a qualified Digital Customer Services engineer. This chapter lists the available services.

### 8.1 Digital Equipment Corporation Services

Digital Equipment Corporation provides a wide range of maintenance programs for printers. These include on-site, carry-in, and mail-in maintenance services. You can use these programs to select a plan that meets your service needs, from complete Digital support to self-maintenance.

Digital offers fast, low-cost, quality maintenance performed at your site by trained service specialists. Whether you select the DECservice or Basic Service agreements, or choose the Time and Materials service, your printer will receive the best possible maintenance.

There are more than 150 Digital carry-in service centers in major cities around the world. These service centers offer convenient, fast, and dependable maintenance at a savings over on-site service.

If you prefer self-maintenance, you can mail in your field replaceable unit (FRU) for repair through our fast-turnaround DECmailer repair service.



For more information on any of Digital Equipment Corporation's maintenance services, call the Digital Customer Services office in your area during normal business hours. Refer to the list of questions in Table 8-1 before calling the service center.

**Table 8-1: Questions to Consider Before You Call**

---

<i>Is the call necessary?</i>	Check Chapter 6. Often you can solve the problem yourself.
<i>Who should call for service?</i>	Typically, the system manager should place the call for service.
<i>Where should you call?</i>	<p>In the continental United States: If you purchased on-site warranty support at the time of sale, call Digital at 1-800-DEC-8000.</p> <p>If you do not have on-site warranty support and are returning the printer to Digital for service, call 1-800-225-5385.</p> <p>For per call service information, call your local Digital sales office.</p> <p>In Alaska, Hawaii, Canada, and Europe: Call your local Digital sales office for service.</p>
<i>What does the service center need to know?</i>	Write down the serial and model numbers located on the label on the rear of the printer.
<i>How should you describe the problem?</i>	<p>Summarize the problem. Make a note of:</p> <ul style="list-style-type: none"><li>• What you were doing when the printer failed</li><li>• Any messages on the display panel</li><li>• Any strange noises</li></ul> <p>Stay by the printer and host system if possible, because the service engineer may ask you to recreate the problem.</p>

---

## Appendix A

# DEClaser Printer Quick Reference Guide

---

This quick reference guide contains basic information on using certain programming instructions with your DEClaser printer. This appendix is designed to be used as a reference source for experienced programmers. If you require detailed programming information, see the Associated Documentation section in the Preface for a listing of available programming manuals.

For quick reference use, see these sections:

---

<b>Category</b>	<b>Section</b>
Positioning Controls	A.1
Margins and Spacing	A.2
Set/Reset Modes	A.3
Fonts and Character Sets	A.4
Control Characters	A.5
Miscellaneous	A.6

---

## **A.1 Positioning Controls**

### **CUU—Cursor Up**

CSI Pn A

Where:

Pn = 0 is treated as 1.

Pn = n is the numeric value according to SSU sequence and PUM setting.

### **DECCAHT—Clear All Horizontal Tabs**

ESC 2

### **DECCA VT—Clear All Vertical Tabs**

ESC 4

### **DECHTS—Horizontal Tab Set**

ESC 1

### **DECSHTS—Set Horizontal Tab Stops**

CSI Pn ; . . . ; Pn u

### **DECSVTS—Set Vertical Tab Stops**

CSI Pn ; . . . ; Pn v

### **DECVTS—Vertical Tab Set**

ESC 3

### **HPA—Horizontal Position Absolute**

CSI Pn `

Where:

Pn = 0 is treated as 1.

Pn = n is the numeric value according to SSU sequence and PUM setting.

### **HPB—Horizontal Position Backward**

CSI Pn j

Where:

Pn = 0 is treated as 1.

Pn = n is the numeric value according to SSU sequence and PUM setting.

### **HPR—Horizontal Position Relative**

CSI Pn a

Where:

Pn = 0 is treated as 1.

Pn = n is the numeric value according to SSU sequence and PUM setting.

### **TBC—Tab Clear**

CSI Ps ; . . . ; Ps g

Where:

Ps = 0 is clear one horizontal tab stop at active column.

Ps = 1 is clear one vertical tab stop at active line.

Ps = 2 is clear all horizontal tab stops.

Ps = 3 is clear all horizontal tab stops.

Ps = 4 is clear all vertical tab stops.

### **VPA—Vertical Position Absolute**

CSI Pn d

Where:

Pn = 0 is treated as 1.

Pn = n is the numeric value according to SSU sequence and PUM setting.

### **VPB—Vertical Position Backward**

CSI Pn k

Where:

Pn = 0 is treated as 1.

Pn = n is the numeric value according to SSU sequence and PUM setting.

### **VPR—Vertical Position Relative**

CSI Pn e

Where:

Pn = 0 is treated as 1.

Pn = n is the numeric value according to SSU sequence and PUM setting.

## A.2 Margins and Spacing

### DEC SHORP—Set Horizontal Pitch

CSI P<sub>s</sub> w

Where:

P <sub>s</sub> = 0	is determined by current font.
P <sub>s</sub> = 1	is 720 centipoints (10 characters/inch).
P <sub>s</sub> = 2	is 600 centipoints (12 characters/inch).
P <sub>s</sub> = 3	is 545 centipoints (13.2 characters/inch).
P <sub>s</sub> = 4	is 436 centipoints (16.5 characters/inch).
P <sub>s</sub> = 5	is 1440 centipoints (5 characters/inch).
P <sub>s</sub> = 6	is 1200 centipoints (6 characters/inch).
P <sub>s</sub> = 7	is 1090 centipoints (6.6 characters/inch).
P <sub>s</sub> = 8	is 872 centipoints (8.25 characters/inch).
P <sub>s</sub> = 9	is 480 centipoints (15 characters/inch).
P <sub>s</sub> = 11	is 420 centipoints (approx. 17.1 characters/inch, or more accurately 14/240 inch).
P <sub>s</sub> = 12	is 840 centipoints (approx. 8.55 characters/inch, or more accurately 28/240 inch).
P <sub>s</sub> = 13	is 400 centipoints (18 characters/inch).
P <sub>s</sub> = 14	is 800 centipoints (9 characters/inch).
P <sub>s</sub> = 15	is 696 centipoints (approx. 10.3 characters/inch, or more accurately 29/300 inch).

### DEC SLPP—Set Lines per Physical Page

CSI P<sub>n</sub> t

### DEC SLRM—Set Left and Right Margins

CSI P<sub>n1</sub> ; P<sub>n2</sub> s

Where:

- P<sub>n1</sub> is the left margin-setting numeric value.
- P<sub>n2</sub> is the right margin-setting numeric value.

## **DECSTBM—Set Top and Bottom Margins**

CSI Pn1 ; Pn2 r

**Where:**

Pn1 is the top margin-setting numeric value.

Pn2 is the bottom margin-setting numeric value.

## **DECVERP—Set Vertical Pitch**

CSI Ps z

**Where:**

Ps = 0 is determined by the current font.

Ps = 1 is 1200 centipoints (6 lines/inch).

Ps = 2 is 900 centipoints (8 lines/inch).

Ps = 3 is 600 centipoints (12 lines/inch).

Ps = 4 is 3600 centipoints (2 lines/inch).

Ps = 5 is 2400 centipoints (3 lines/inch).

Ps = 6 is 1800 centipoints (4 lines/inch).

Ps = 10 is 1152 centipoints (66 lines/A-size printable area).

Ps = 11 is 1152 centipoints (66 lines/A-size printable area).

Ps = 12 is 864 centipoints (88 lines/A-size printable area).

Ps = 13 is 576 centipoints (132 lines/A-size printable area).

Ps = 14 is 3456 centipoints (22 lines/A-size printable area).

Ps = 15 is 2304 centipoints (33 lines/A-size printable area).

Ps = 16 is 1728 centipoints (44 lines/A-size printable area).

## DECVPFS—Variable Page Format Select

CSI Ps1 ; Pn2 ; . . . Pn11 SP z

Where:

Ps1 = 0, 1 is portrait orientation.

Ps1 = 2 is landscape orientation.

Ps1 = Other is portrait orientation.

---

<b>Pn =</b>	<b>Meaning</b>	<b>If "Zero"</b>
2	Length of paper	Default <sup>1</sup>
3	Width of paper	Default <sup>1</sup>
4	Top margin	1
5	Bottom margin	Pn2—1/2 in.
6	Left margin	1
7	Right margin	Pn3—1/2 in.
8	Page home line	Top margin
9	Page end line	Bottom margin
10	Line home position	Left margin
11	Line end position	Right margin

---

<sup>1</sup>The length and width default to the active paper tray values.

---

## GSM—Graphic Size Modification

CSI Pn1 ; Pn2 SP B

Where:

Pn1 = 0 is treated as 100% of height set by GSS.

Pn1= Decimal value is the percentage of the height set by GSS.

Pn2 = 0 is treated as 100% of the width set by GSS.

Pn2= Decimal value is the percentage of the width set by GSS.



## **GSS—Graphic Size Select**

CSI Pn SP C

### **Where:**

Pn = 0 is 100 decipoints.

Pn = n is the font height according to SSU sequence.

## **PFS—Page Format Select**

CSI Ps SP J

CSI ?Ps SP J—(Digital Private)

### **Where:**

Ps = 0 is portrait normal text.

Ps = 1 is landscape normal text.

Ps = 2 is portrait normal A4.

Ps = 3 is landscape normal A4.

Ps = 4 is portrait normal North American letter.

Ps = 5 is landscape normal North American letter.

Ps = 6 is portrait extended A4.

Ps = 7 is landscape extended A4.

Ps = 8 is portrait extended legal.

Ps = 9 is landscape extended legal.

Ps = ?20 is portrait extended North American private.

Ps = ?21 is landscape extended North American private.

Ps = ?22 is portrait extended A4 private.

Ps = ?23 is landscape extended A4 private.

Ps = ?24 is portrait extended legal private.

Ps = ?25 is landscape extended legal private.

### **SHS—Set Horizontal Spacing**

CSI Ps SP K

#### **Where:**

Ps = 0 is 720 centipoints (10 characters/inch).

Ps = 1 is 600 centipoints (12 characters/inch).

Ps = 2 is 480 centipoints (15 characters/inch).

Ps = 3 is 1200 centipoints (6 characters/inch).

### **SPI—Spacing Pitch Increment**

CSI Pn1 ; Pn2 SP G

#### **Where:**

Pn1 = 0 vertical spacing is determined by current font.

Pn1 = n is the vertical spacing according to the SSU sequence and PUM setting.

Pn2 = 0 horizontal spacing is determined by current font.

Pn2 = n is the horizontal spacing according to the SSU sequence and PUM setting.

### **SSU—Select Size Unit**

CSI Ps SP I

CSI ?Ps SP I—(Digital Private)

#### **Where:**

Ps = 2 is decipoint (1/720 inch.)

Ps = 7 is pixel (1/300 inch.)

Ps = ?1 is centipoint (1/7200 inch.)

## **SVS—Set Vertical Spacing**

CSI Ps SP L

Where:

Ps = 0 is 1200 centipoints (6 lines/inch, 1/6 inch).

Ps = 1 is 1800 centipoints (4 lines/inch, 1/4 inch).

Ps = 2 is 2400 centipoints (3 lines/inch, 1/3 inch).

Ps = 3 is 600 centipoints (12 lines/inch, 1/12 inch).

Ps = 4 is 900 centipoints (8 lines/inch, 1/8 inch).

Ps = 5 is 1416 centipoints (6 lines/30 mm, 5 mm).

Ps = 6 is 2136 centipoints (4 lines/30 mm, 7.5 mm).

Ps = 7 is 2856 centipoints (3 lines/30 mm, 10 mm).

Ps = 8 is 720 centipoints (12 lines/30 mm, 2.5 mm).

Ps = 9 is 3600 centipoints (2 lines/inch, 1/2 inch).

## **A.3 Set/Reset Modes**

CSI Ps h Set Mode

CSI Ps l Reset Mode

Where:

Ps = 3 is CRM—Control Representation Mode

Ps = 11 is PUM—Positioning Unit Mode

Ps = 20 is LNM—Line Feed/New Line Mode

Ps = ?7 is DECAWM—Autowrap Mode

Ps = ?27 is DECPSP—Proportional Spacing Mode

Ps = ?29 is DECPSM—Horizontal Pitch Select Mode

Ps = ?40 is DECCRNLM—Carriage Return/New Line Mode

Ps = ?52 is DECOPM—Origin Placement Mode

## A.4 Fonts and Character Sets

### ASCEF—Announce Subset of Code Extension Facilities

ESC SP F

If the final character (F) is:

- L the subset is ISO 4873, Level 1.
- M the subset is ISO 4873, Level 2.
- N the subset is ISO 4873, Level 3.

### DECATFF—Assign Type Family or Font

DCS Ps1 ; Ps2 } id\_string ST

Where:

- Ps1 = 0, 1 assigns a font collection plus with a 16-character font ID to SGR number.
- Ps1 = 2 assigns type family ID (7 characters) to SGR number.
- Ps1 = 3 assigns a 16-character font ID to SGR number.
- Ps1 = 4 assigns a 12-character font collection ID to SGR number.

Ps2 = 10...19 is the font selection parameter used with SGR.

## **DECAUPSS—Assign User Preference Supplemental Character Set**

DSC Ps ! u D . . . D ST

Where:

Ps = 0 is a 94-character set.

Ps = 1 is a 96-character set.

Possible D . . . D values:

2/5,3/5	DEC Supplemental	(Ps = 0)
4/1	ISO Latin-1 Supplemental	(Ps = 1)
4/9	JIS Katakana <sup>1</sup>	(Ps = 0)
2/2,3/4	DEC Hebrew Supplemental	(Ps = 0)
4/8	ISO Latin-Hebrew Supplemental	(Ps = 1)
3/14	DEC Technical	(Ps = 0)

## **DECDTFF—Delete Type Family or Font File**

DCS Ps ~ id\_string ST

Where:

Ps = 0 indicates that the ID string is a 7-character type family ID.

Ps = 1 indicates that the ID string is a 31-character font file ID.

## **DECLFF—Load Font File**

DCS Ps1 ; Ps2 ; Ps3 y font\_record, font\_record; comment\_record ST

Where:

Ps1 = 0 is Digital font file format.

Ps2 = 0 is print summary sheet.

Ps2 = 1 is do not print summary sheet.

Ps2 = 2 send font error and warning information (response is DECFSR (DECLFF Ps2 = 2 or 3)).

Ps2 = 3 is print summary sheet and send font error/warning information.

Ps3 = 0 is delete all fonts.

Ps3 = 1 is replace loaded font files with same ID as loaded font file.

## **LS1R—Locking Shift 1 Right**

ESC ~

## **LS2—Locking Shift 2**

ESC n

## **LS3—Locking Shift 3**

ESC o

## **LS2R—Locking Shift 2 Right**

ESC }

## **LS3R—Locking Shift 3 Right**

ESC |

## SCS—Select Character Set

ESC I\* . . . In F

---

<b>I* Character</b>	<b>Code</b>	<b>Set Selection</b>
<b>94-Character Sets</b>		
( Left parenthesis	2/8	G0
) Right parenthesis	2/9	G1
* Asterisk	2/10	G2
+ Plus sign	2/11	G3
<b>96-Character Sets<sup>1</sup></b>		
- Minus Sign	2/13	G1
. Period	2/14	G2
/ Slash	2/15	G3

---

<sup>1</sup>You cannot designate a 96-character set into G0.

---

<b>G0</b>	<b>G1</b>	<b>G2</b>	<b>G3</b>	<b>Character Set</b>
ESC ( B	ESC ) B	ESC * B	ESC + B	ASCII
ESC ( A	ESC ) A	ESC * A	ESC + A	British NRCS
ESC ( 5	ESC ) 5	ESC * 5	ESC + 5	DEC Finnish NRCS
ESC ( R	ESC ) R	ESC * R	ESC + R	French NRCS
ESC ( 9	ESC ) 9	ESC * 9	ESC + 9	DEC French Canadian NRCS
ESC ( K	ESC ) K	ESC * K	ESC + K	German NRCS
ESC ( Y	ESC ) Y	ESC * Y	ESC + Y	ISO Italian NRCS
ESC ( J	ESC ) J	ESC * J	ESC + J	JIS Roman
ESC ( I	ESC ) I	ESC * I	ESC + I	JIS Katakana
ESC ( 6	ESC ) 6	ESC * 6	ESC + 6	DEC Norwegian/Danish NRCS
ESC ( Z	ESC ) Z	ESC * Z	ESC + Z	ISO Spanish NRCS
ESC ( 7	ESC ) 7	ESC * 7	ESC + 7	DEC Sweden
ESC ( <	ESC ) <	ESC * <	ESC + <	User-Preference Supplemental Set
ESC ( 0	ESC ) 0	ESC * 0	ESC + 0	DEC Special Graphics
ESC ( >	ESC ) >	ESC * >	ESC + >	DEC Technical
ESC ( ')	ESC ) ')	ESC * ')	ESC + ')	Norwegian/Danish NRCS
ESC ( 4	ESC ) 4	ESC * 4	ESC + 4	DEC Dutch NRCS
ESC ( =	ESC ) =	ESC * =	ESC + =	DEC Swiss NRCS
ESC ( % 6	ESC ) % 6	ESC * % 6	ESC + % 6	DEC Portuguese NRCS
N/A	ESC - A	ESC . A	ESC / A	ISO Latin-1 Supplemental <sup>1</sup>
ESC ( % 5	ESC ) % 5	ESC * % 5	ESC + % 5	DEC Supplemental
N/A	ESC - H	ESC . H	ESC / H	ISO Latin-Hebrew Supplemental <sup>1</sup>
ESC ( " 4	ESC ) " 4	ESC * " 4	ESC + " 4	DEC Hebrew Supplemental
ESC ( % =	ESC ) % =	ESC * % =	ESC + % =	DEC 7-Bit Hebrew

<sup>1</sup>This is a 96-character set.



## SGR—Select Graphic Rendition

CSI Ps ; . . . ; Ps m

CSI ?Ps ; . . . ; Ps m—(Digital Private)

### Where:

Ps = 0 or none	turns off all attributes (standard and private).
Ps = 1	turns on bold.
Ps = 3	turns on italics.
Ps = 4	turns on underline (double underline off).
Ps = 9	turns on strike-through.
Ps = 10	is used as defined by DECATFF.
.	.
.	.
.	.
Ps = 19	is used as defined by DECATFF.
Ps = 21	turns on double underline (underline off).
Ps = 22	turns off bold.
Ps = 23	turns off italics.
Ps = 24	turns off underline and double underline.
Ps = 29	turns off strike-through.
Ps = 53	turns on overline.
Ps = 55	turns off overline.
Ps = ?0	is all private attributes off (including overline).
Ps = ?4	is superscript on, subscript off.
Ps = ?5	is subscript on, superscript off.
Ps = ?6	turns on overline.
Ps = ?24	turns off superscript and subscript.
Ps = ?26	turns off overline.

## A.5 Control Characters

### Recognized C0 Control Characters

0/0	NUL	Null
0/8	BS	Backspace
0/9	HT	Horizontal Tab
0/10	LF	Line Feed
0/11	VT	Vertical Tab
0/12	FF	Form Feed
0/13	CR	Carriage Return
0/14	SO	Shift Out (Locking Shift Zero)
0/15	SI	Shift In (Locking Shift One)
1/1	DC1	Device Control 1 (XON)
1/3	DC3	Device Control 3 (XOFF)
1/8	CAN	Cancel
1/10	SUB	Substitute
1/11	ESC	Escape

### Recognized C1 Control Characters

8/4	ESC D	IND	Index
8/5	ESC E	NEL	Next Line
8/8	ESC H	HTS	Horizontal Tab Set
8/10	ESC J	VTS	Vertical Tab Set
8/11	ESC K	PLD	Partial Line Down
8/12	ESC L	PLU	Partial Line Up
8/13	ESC M	RI	Reverse Index
8/14	ESC N	SS2	Single Shift Two
8/15	ESC O	SS3	Single Shift Three
9/0	ESC P	DCS	Device Control String
9/11	ESC [	CSI	Control Sequence Introducer
9/12	ESC \	ST	String Terminator

## **A.6 Miscellaneous**

### **CPR—Cursor Position Report**

CSI Pnv ; Pnh R

Where:

Pnv is a numeric parameter describing the active vertical position.

Pnh is a numeric parameter describing the active horizontal position.

### **DA—Device Attributes (request)**

CSI c Primary DA request

### **DA2—Secondary Device Attributes (request)**

CSI > c

### **DAR—Device Attributes (DA) Report**

CSI ? Ps1 ; Ps2 ; . . . ; Psn c Where:

Ps1 = 73 identifies the printer as a level 3 device.

Ps1 = 26 identifies the printer as an LN03.

Ps2 = 4,...16 indicates DEClaser 1100 extensions.

## **DA2R—Secondary Device Attributes Report**

CSI > Ps1 ; Ps2 ; Ps3 ; Ps4 ; Ps5 c

### **Where:**

Ps1 = 51 identifies the printer as a DEClaser 1100.

Ps2 = xx is the major firmware revision.

Ps3 = 0 is no memory card.

Ps3 = 1 is 1 MB memory card.

Ps3 = 2 is 2 MB memory card.

Ps4 = 0,...24 are the protocol cartridges installed.

Ps5 = yy is the minor firmware revision.

## **DECASFC—Automatic Sheet Feeder (Input Tray) Control**

CSI Ps ! v

### **Where:**

Ps = 0 is no tray change (conditional Sheet Feed is performed).

Ps = 1 is paper tray.

Ps = 2 is paper cassette (if present).

### **DECFSR—Font Status Report**

If DECFSR Ps = 0 or 1:

```
DCS 1 " { report_string ST
```

If DECFSR Ps = 0 or 2:

```
DCS 2 " { nnn ST
```

Where:

*nnn* indicates the number of bytes available in memory for downline loading.

If DECLFF Ps2 = 2 or 3:

```
DCS 4 " { error_string ST
```

### **DECM—Memory Management**

```
CSI Ps + v
```

Where:

Ps = 0, 1 is no *guaranteed* imaging capabilities.

Ps = 2 is A or A4-size image guaranteed without complexity errors.

Ps = 3 is legal-size image guaranteed without complexity errors.

Ps = 4 is A or A4-size image guaranteed without complexity errors for two images.

### **DECNS—New Sheet**

```
CSI SP s
```

### **DECFSR—Request Font Status**

```
CSI Ps " {
```

Where:

Ps = 0 is send both Font Status Reports (DECFSR)

Ps = 1 is send font repertoire DECFSR

Ps = 2 is send memory status DECFSR

### **DECRVEC—Draw Relative Vector**

CSI Ps1 ; Pn2 ; Pn3 ; SP |

#### **Where:**

Ps1 = 0 is draw an X line to the right.

Ps1 = 1 is draw a Y line down.

Ps1 = 2 is draw an X line to the left.

Ps1 = 3 is draw a Y line up.

Pn2 = is the line length according to SSU sequence.

Pn3 = is the line width according to SSU sequence.

### **DECSCL—Set Conformance Level**

CSI Ps1 " p

#### **Where:**

Ps1 = 0 is treated as 73.

Ps1 = 71 is reset to DEC PPL1 defaults.

Ps1 = 72 is reset to DEC PPL2 defaults.

Ps1 = 73 is reset to DEC PPL3 defaults.

## DECSDPM—Set Duplex Print Mode

CSI P<sub>s</sub> SP x

---

P <sub>s</sub>	Print Mode	Physical State	Tumbling State	DEClaser	
				1100/2100 Fallback	DEClaser 2200 Fallback
0	True simplex normal	Simplex	Off	–	–
1	True simplex normal	Simplex	Off	–	1
2	True simplex tumbled	Simplex	On	1	1
3	True duplex normal	Duplex	Off	5	3
4	True duplex tumbled	Duplex	On	5	4
5	Duplex master normal	Simplex	Off	5	5
6	Duplex master tumbled	Simplex	On	5	6
7	Simplex compressed normal	Duplex	Off	1	7
8	Simplex compressed tumbled	Duplex	On	1	7

---

## DECSNC—Set Number of Copies

CSI P<sub>n</sub> & q

Where:

P<sub>n</sub> = 0 is treated as 1.

P<sub>n</sub> = 1–99 is the number of copies.

P<sub>n</sub> = >99 is treated as 99.

### **DECSSS—Set Sheet Size**

CSI Ps1 ; Ps2 ; Pn3 ; Pn4 SP {

#### **Where:**

- Ps1 = 0 is any slot.
- Ps1 = 1 is paper tray.
- Ps1 = 2 is paper cassette (if present).
  
- Ps2 = is key number (ignored).
- Pn3 = is width (defined as leading edge).
- Pn4 = is length.

### **DECSTR—Soft Terminal Reset**

CSI ! p

### **DECVEC—Draw Vector**

CSI Ps1 ; Pn2 ; Pn3 ; Pn4 ; Pn5 ! |

#### **Where:**

- Ps1 = 0 is draw X (horizontal) line.
- Ps1 = 1 is draw Y (vertical) line.
- Ps1 = Other is perform no action.
  
- Pn2 = is X (horizontal line) start position (according to SSU sequence).
- Pn3 = is Y (vertical line) start position (according to SSU sequence).
- Pn4 = is line length (according to SSU sequence).
- Pn5 = is line width (according to SSU sequence).



## **DSR—Device Status Request**

CSI Ps n

CSI ?Ps n

### **Where:**

Ps = 0,5 is send an extended status report.

Ps = 6 is send a Cursor Position Report (CPR).

Ps = ?1 is disable all unsolicited status reports.

Ps = ?2 is enable brief unsolicited status reports, and send extended status report.

Ps = ?3 is enable extended unsolicited status reports, and send extended status report.

## **JFY—Justify**

CSI Ps SP F

### **Where:**

Ps = 0 is stop justification.

Ps = 2 is justify with limits.

Ps = ?2 is justify without limits.

## **RIS—Reset to Initial State**

ESC c

## **SnC1R—C1 Receive Mode**

ESC SP interprets C1 as C0.  
6

ESC SP interprets C1 as C1.  
7

## Appendix B

# Accessories and Supplies

---

This appendix lists some of the accessories and supplies available for the DEClaser 1100 printer. Contact your local sales representative or refer to your latest DECdirect catalog for a complete list of products and the latest pricing information. See Section B.1 for additional ordering information.

**Table B-1: DEClaser 1100 Printer Accessories and Supplies**

<b>Part Number</b>	<b>Description</b>
LNXX-CA <sup>1</sup>	CG Times proportional font cartridge
LNXX-CB <sup>1</sup>	CG Triumvirate proportional font cartridge
LNXX-CC <sup>1</sup>	ITC Souvenir and Script proportional font cartridge
LNXX-CD <sup>1</sup>	Monospaced font cartridge
LNXX-CN	CaPSL emulation cartridge
LN07X-PC	HP LaserJet IIP and IBM Proprinter X24E emulation
LN07X-HM <sup>2</sup>	Microsoft font cartridge
LN07X-HW <sup>2</sup>	WordPerfect font cartridge
LN07X-HT <sup>2</sup>	Multifont cartridge
LN07X-PS	PostScript cartridge
LN07R-UA	PostScript upgrade kit
LN07X-TB	Legal-size paper cassette (8 ½ in. x 14 in.)
LN07X-TA	A4-size paper cassette (297 mm x 210 mm)
LN07X-TE	Executive-size paper cassette (7 ¼ in. x 10 ½ in.)
LN07X-TD	Envelope cassette
LN07X-TC	Letter-size paper cassette (8 ½ in. x 11 in.)
LN07X-TF	Letter-size paper feeder unit

---

<sup>1</sup>Fonts for use with DEC PPL3 protocol.

<sup>2</sup>Fonts for use with HP PCL protocol.

**Table B-1 (Cont.): DEClaser 1100 Printer Accessories and Supplies**

<b>Part Number</b>	<b>Description</b>
LN07X-TG	A4-size paper feeder unit
LN07X-MA	1 MB RAM module
LN07X-MC	1 MB RAM daughter module
LN07X-AA	EP-L Cartridge Kit (Quantity = 1)
LN03X-AE	Mobile printer cabinet/stand
H8571D-A	25-pin male-to-MMJ adapter
H8571D-B	9-pin male-to-MMJ adapter (Digital)
H8571-C	25-pin cable-to-MMJ adapter
H8571-D	25-pin female-to-MMJ adapter (modem)
H8571-J	9-pin PC type-to-MMJ adapter
H8673-AA	20mA active host Mate-N-Lock to EIA-423 DECconnect MMJ passive converter
H8673-AB	20mA active host RJ11 (6-pin) to EIA-423 DECconnect MMJ passive converter
H9850-TA	Laser labels (30/sheet x 100 sheets per box)
H9850-TB	Laser labels (21/sheet x 100 sheets per box)
BC19M-10	IBM/Centronics parallel cable
LN01X-AB	Letter-size paper 8 ½ in. x 11 in. 5,000 sheets per box
LN01X-AD	A4-size paper 297 mm x 210 mm 5,000 sheets per box
LN01X-AC	Legal-size paper 8 ½ in. x 14 in. 5,000 sheets per box
LN03X-AJ	Letter-size transparencies 8 ½ in. x 11 in. 50 sheets per box
LN03X-AK	A4-size transparencies 297 mm x 210 mm 50 sheets per box

## B.1 Ordering Information

Use the following mailing addresses and telephone numbers to order products for the DEClaser 1100 printer.

### Table B-2: Ordering Within the U.S.A.

---

<b>MAIL</b>	Digital Equipment Corporation PO Box CS2008 Nashua, NH 03061
<b>TELEPHONE</b>	Order toll free 1-800-DIGITAL between the hours of 8:30 a.m. and 8:00 p.m. EST

---

### Table B-3: Ordering Outside the U.S.A.

---

<b>MAIL</b>	Digital Equipment Corporation Attention: Accessories & Supplies Business Manager c/o Local Subsidiary or Digital-Approved Distributor
<b>TELEPHONE</b>	
In Canada	Order toll free 1-800-267-6215
In Australia	Outside Sydney Metropolitan Area (toll free): 008-226-363 From Sydney Metropolitan Area: 412-7000
In New Zealand	Auckland (toll free): 0800-800-332

---

## Appendix C

# Specifications

---

This appendix contains the operating and interface specifications for the DEClaser 1100 printer.

### C.1 Operating Specifications

<b>Type:</b>	Desktop page printer
<b>Printing Method:</b>	Electrophotographic using laser beam scanning
<b>Resolution:</b>	300 dpi
<b>Printing Speed:</b>	4 pages/minute maximum using A4 or letter-size paper from the cassette
<b>Warm-Up Time:</b>	Less than one minute at 20°C (68°F)
<b>Paper Tray:</b>	Approximate capacity is 50 sheets of paper, labels, or transparencies. A maximum of five envelopes can be loaded in the paper tray.
<b>Optional Paper Cassettes:</b>	Approximate capacity is 250 sheets Letter (8 ½ in. x 11 in.) A4 (210 mm x 297 mm) Executive (7 ¼ in. x 10 ½ in.) Legal (8 ½ in. x 14 in.)
<b>Top Output Tray Capacity:</b>	50 sheets (facedown stacking)
<b>Front Output Tray Capacity:</b>	20 sheets (faceup stacking)
<b>Paper Weight Range Cassette Feed:</b>	60 g/m <sup>2</sup> to 90 g/m <sup>2</sup> basis weight (16 lb. to 24 lb.)
<b>Paper Weight Range Paper Tray Feed:</b>	60 g/m <sup>2</sup> to 105 g/m <sup>2</sup> basis weight (16 lb. to 28 lb.)

<b>Built-in Font Files:</b>	<p>The DEClaser 1100 printer has 36 built-in font files. The font files consist of four fonts and nine character sets. These fonts are:</p> <ul style="list-style-type: none"> <li>• Courier 10-point normal<sup>1</sup> portrait</li> <li>• Courier 10.3-point normal portrait</li> <li>• Courier 6.7-point normal landscape</li> <li>• Elite 10-point normal portrait</li> </ul> <p>For each font the following character sets reside in the printer:</p> <ul style="list-style-type: none"> <li>• ASCII</li> <li>• DEC Supplemental</li> <li>• ISO Latin-1 Supplemental</li> <li>• DEC Technical</li> <li>• DEC Special Graphics (VT100 Line Drawing)</li> <li>• DEC 7-Bit Hebrew</li> <li>• DEC Hebrew Supplemental</li> <li>• ISO Latin-Hebrew Supplemental</li> <li>• Legal</li> </ul>
<b>Font Cartridges:</b>	Capacity for two optional font cartridges
<b>Built-in RAM:</b>	512 KB, expandable to 2.5 MB with optional RAM boards
<b>Host Interface:</b>	Parallel (Centronics) and serial (RS232C)
<b>Acoustic Noise:</b>	43dB(A) maximum during standby 53dB(A) maximum during printing
<b>Operating Temperature:</b>	10°C to 32.5°C (50°F to 90.5°F)
<b>Operating Humidity:</b>	20% to 80% relative humidity (no condensation)
<b>Storage Temperature:</b>	0°C to 35°C (32°F to 95°F)
<b>Storage Humidity:</b>	10% to 80% relative humidity (no condensation)
<b>Power Requirements:</b>	100–115V AC, 50/60 Hz 220–240V AC, 50 Hz

---

<sup>1</sup>Normal means that the font is not set in bold or italics or otherwise attributed.

<b>Power Consumption:</b>	less than 0.55 kW (VA)
<b>Installed Weight:</b>	Approximately 11.0 kg (25 lb.)
<b>Dimensions:</b>	Width: 350 mm (13.8 in.) Depth: 405 mm (15.9 in.) Height: 204 mm (8.0 in.) Height: 259 mm (10.2 in.) with the optional paper feed unit and cassette installed.

## C.2 Serial Interface Specifications

Table C-1 lists the pin signals for the RS232C serial interface connector. Figure C-1 shows the pin assignments on the connector, while Figure C-2 and Figure C-3 show the serial connections with and without connection to a modem.

**Table C-1: Serial Interface Pin Assignments**

Pin	Signal	Direction
1	Frame Ground	–
2	Transmit Data	Out
3	Receive Data	In
4	Request to Send	Out
5	Not Used	–
6	Data Set Ready	In
7	Signal Ground	–
8–19	Not Used	–
20	Data Terminal Ready	Out
21–25	Not Used	–

**Figure C-1: RS232C Pin Assignments**

MLO-004884



**Figure C-2: Serial Connections to Modem**

MLO-004885

**Figure C-3: Serial Connections Without Modem**

MLO-005829

### **C.3 Parallel Interface Specifications**

Table C-2 lists the pin signals for the parallel (Centronics) interface connector. Figure C-4 shows the pin assignments on the connector, while Figure C-5 shows the parallel connections to an external device.

**Table C-2: Parallel Interface Pin Assignments**

<b>Pin</b>	<b>Signal</b>	<b>Direction</b>
1	$\overline{DataStrobe}$	In
2	Data 1	In
3	Data 2	In
4	Data 3	In
5	Data 4	In
6	Data 5	In
7	Data 6	In
8	Data 7	In
9	Data 8	In
10	$\overline{ACK}$	Out
11	Busy	Out
12	Call (PE)	Out
13	Select	Out
14–15	Not Connected	–
16	0 Volts (Logic Ground)	–
17	Chassis Ground	–
18	5 Volts	Out
19–29	Ground	–
30	$\overline{InputPrimeRet}$	Out
31	$\overline{InputPrime}$	In
32	$\overline{Fault}$	Out
33	Aux Out 1 <sup>1</sup>	–
34	Not Connected	–
35	Aux Out 2 <sup>1</sup>	–
36	Not Connected	–

<sup>1</sup>Ignored

**Figure C-4: Parallel Pin Assignment**

MLO-004886

**Figure C-5: Parallel Connections**

MLO-005828

## Appendix D

# LN03 Compatibility

---

This appendix contains information highlighting the differences between the DEClaser 1100 printer and the LN03 printer. This information is directed at the differences affecting compatibility between the printers.

### D.1 General Differences

The following list identifies the general differences between the LN03 printer and the DEClaser 1100 printer.

- A 25-pin (female) serial cable and an MMJ-to-25-pin male adapter are provided with the DEClaser 1100 printer. The LN03 does not come with an interface cable.
- Font cartridges for the DEClaser 1100 printer do not have the same physical format, or the same internal data format, as the font cartridges for the LN03. If your application requires special cartridges (logos, signatures, private character sets), you need to use a soft copy or have a new cartridge made.
- The DEClaser 1100 printer comes with 512 KB of RAM, and can be upgraded up to 2.5 MB. This memory is not dedicated as it is on the LN03. For example, the LN03 PLUS option is dedicated to bitmap processing, while the RAM cartridges are dedicated to font storage. On the DEClaser 1100 printer you can use the available memory for font storage, bitmap storage, or a display list. When you want to ensure the availability of bitmap memory, use DEC Memory Management (DECMEM), or the Paint feature in the INITIAL Menu (see Table 4-12) to allot the proper memory space. When you want to ensure the availability of font memory, load the fonts at the beginning of the print job.
- The DEClaser 1100 printer does not use DIP switches to select features. Instead, it uses setup menus and a nonvolatile memory to select and save features.
- When the DEClaser 1100 printer encounters a “page-too-complex” error, it stops until the error is cleared with the `[Error Skip]` key (see Section 6.1).

## D.2 Printable Area Compatibility

The printable area on the DEClaser 1100 is approximately the same as the printable area on the LN03 printer. There is an approximate 6 mm (¼ in.) nonprintable area around the page.

This difference does not affect any application using the predefined Page Format Selections (PFS), or applications that do not print within 6 mm (¼ in.) of the paper edge. When the LN03 printer encounters a character that exceeds the printable area, it sometimes tries to shift the character so that it falls within the printable area. The DEClaser 1100 printer does not image any characters exceeding the printable area. This results in lost characters.

## D.3 Protocol Compatibility

The following list contains protocol compatibility issues between the LN03 printer and the DEClaser 1100 printer.

- The LN03 rounds a relative motion of 1 decipoint down to a relative motion of 0, causing cumulative errors; the DEClaser 1100 keeps its position accurately. This produces a side effect when a relative motion of 0 is interpreted as a relative motion of 1 by both devices when using decipoints. This leads to 0 motion on the LN03, and a 1 decipoint motion on the DEClaser 1100.
- When trying to image past the bottom margin, the LN03 printer does not always wrap. Wrapping depends on the glyph shape and the line spacing. For example “j” may print but “a” may not. The DEClaser 1100 printer always wraps if the character box crosses the bottom margin, even though the character may not have a descender. This ensures that all characters either print, or all characters wrap to the next page.
- You should use the level 3 device identification for the DEClaser 1100 printer when possible. This allows the software to be compatible with any future devices.

Some applications, such as DECmate, require you to set the printer up to respond as an LN03 printer. When the device identification is set to LN03, it responds as a base model LN03, not an LN03 PLUS, even though it may have sufficient memory for a full bitmap. See Section 4.5.5.1 for additional information about the device identification.

- The DEClaser 1100 does not support Tektronix mode; the LN03 PLUS does.

- The DEClaser 1100 does not contain the Modern Gothic font resident in the LN03-PLUS.
- If a font used on the page is deleted to free up memory for another requirement, the DEClaser 1100 may cause a page break but, unlike the LN03 PLUS, does not try to transfer the display list to bitmap memory. If you encounter page breaks, set the Paint feature value to Full (see Table 4–12).

**NOTE:** *The Full value can be activated only if at least 1 MB of optional RAM is installed in the printer.*

- When a font report is issued, the DEC Supplemental character set is now reported as 245 (94-character set %5), rather than 010 (94-character set <), which is now the User Preference character set. The DEClaser 1100 has three Hebrew character sets and the Legal character set resident in the printer. This also modifies the font status report because more fonts are included.
- The DEClaser enforces the Common Font File Format (CFFF) syntax and semantics more strictly than the LN03. Therefore, some fonts containing errors, which load correctly on the LN03, may not load properly on the DEClaser 1100 and will generate an error report.
- The DEClaser 1100 can save more user default settings in NVRAM than the LN03 can save using dip switches. Therefore, when a reset command is received more values can be saved in the DEClaser 1100. To ensure that values are not cleared during a reset, save them to NVRAM whenever possible.

# Glossary

---

**ASCII**

Abbreviation for American Standard Code for Information Interchange. The ASCII code table is widely used for data processing and communication, providing a set of characters and commands. The codes listed represent a set of characters and commands.

**A4 paper size**

The European paper size of 210 mm x 297 mm.

**basis weight**

A measurement used to describe the paper weight density in grams per square meter. Acceptable basis weight ranges for the printer are from 60g/m<sup>2</sup> to 105g/m<sup>2</sup>, or the equivalent of 16 lb. to 28 lb. To determine the basis weight in pounds, divide the g/m<sup>2</sup> by 3.75.

**baud rate**

The speed (bits/second) at which the computer and the printer communicate when a serial interface is used.

**bitmap**

An image in digitized form that can be stored, transmitted, and reproduced precisely.

**bitmap font**

The type of font created from a bitmap pattern. A bitmap font has a fixed size, similar to the type set in typography. The Courier font that resides in the DEClaser 1100 printer is an example of a bitmap font.

**buffer**

An area in the printer's memory used for temporary storage of data during input and output operations.

**built-in fonts**

Fonts that reside in memory and are shipped with the printer. These fonts are sometimes referred to as internal, or resident, fonts.



**CaPSL**

Abbreviation for Canon Printing System Language. This page description language uses escape sequences to control the printer.

**character attribute**

A feature of a highlighted character. You can select underlining, bold printing, italic printing, and strike-through attributes.

**character set**

A set of codes that describe the general appearance of a set of characters. For example, a character set might contain the code for an uppercase A or the number 1. Character sets do not describe the style (font) of a printed character.

**command**

An instruction that tells the printer to perform a certain function. Commands are sent from the host computer to the printer when the printer is on line.

**configuration**

The process of changing the settings of the printer or computer to communicate properly with each other. For example, if you use a serial interface, features such as baud rate and rsmode must be configured to match the host computer and printer.

**default**

A value or setting the printer assumes unless specific changes are made. For example, the interface default value for the DEClaser 1100 printer is RS232C (serial). Default values are stored in ROM and cannot be changed.

**downline loaded fonts**

Fonts that are transferred (downline loaded) from the host computer and temporarily stored in the printer's memory. The downline loaded fonts have priority over the built-in fonts and are cleared when you use a software command or when you power off the printer.

**dpi**

Abbreviation for dots per inch. Dpi is a unit of measurement to indicate printer resolution. The DEClaser 1100 printer has a print resolution of 300 dpi.

**DTR**

Abbreviation for Data Terminal Ready. DTR notifies the host that the printer is powered on. In other installations DTR is used to regulate flow

**Glossary-2**

control or monitor printer on line status. DTR is sometimes known as the hardware handshaking protocol.

**EP-L cartridge**

Abbreviation for electrophotographic laser cartridge. The EP-L cartridge contains toner, a photosensitive drum, and a cleaning mechanism for excess toner.

**error skip**

The process of acknowledging an error (by pressing Error Skip) and then continuing to print. Some errors cannot be bypassed with the error skip procedure.

**fixing assembly**

The fixing assembly contains heat and pressure rollers that bond the toner to the paper. The fixing assembly is sometimes referred to as a fusing unit.

**font**

The artistic representation of a typeface that describes a set of characters by point size, weight, and style.

**font attributes**

The seven characteristics of a font that define how printed characters look when you use that font: type family, spacing, type size, scale factor, typeset, character weight, and character proportion. These attributes are not affected by the character set you use.

**font file**

A data file that contains information used to reproduce a particular font.

**font file ID**

A 31-character code that describes the character set and font attributes for a given font file.

**font ID**

A 16-character code that describes the seven basic font attributes (including type family) of the ROM fonts. The code cannot contain lowercase letters.

**host**

The computer that provides services and enables startup and management of peripheral devices, such as printers.

**image area**

The printable portion of a page. Like most printers, the DEClaser 1100 does not allow printing to the physical edge of the page.

**initialize**

To set starting values such as counters, switches, or addresses at the beginning of, or at prescribed points in, a computer routine.

**interface**

The connection of two devices (through the interface cable), such as a computer and printer, making communication between them possible. The DEClaser 1100 printer supports a parallel (Centronics) interface, a serial (RS232C) interface, and a video interface.

**landscape printing**

A method of printing characters parallel to the long edge of the paper. Landscape printing is typically used for printing wide charts or tables.

**LCD**

Abbreviation for liquid crystal display. The printer messages appear on the LCD, which is part of the control panel.

**letter size**

The North American paper size of 8 ½ in. x 11 in.

**line weight**

The thickness of a line. The thicker the line, the heavier the line weight.

**menu**

A list of the features and values used to configure the printer. For example, the interface menu contains the baud rates used to communicate with the host computer. For the DEClaser 1100 printer, six menus comprise the current printer settings.

**moisture content**

The ratio of water to the dry mass of paper. The moisture content can vary, depending on the type of paper and the amount of humidity it is exposed to.

**NVRAM**

Abbreviation for nonvolatile random-access memory. Nonvolatile means that data is retained even after the printer is powered off. NVRAM is particularly useful when you are setting up the printer configuration, because all of the values can be saved and retained.

**off line**

A communications mode during which the printer cannot receive data from the host computer. When the On Line indicator is off, it indicates that the printer is off line.

**on line**

A communications mode during which the printer can receive data from the host computer. When the On Line indicator is on, it indicates that the printer is on line.

**operating memory**

The memory that contains the current print settings loaded from NVRAM, and any modifications. Operating memory is RAM, which is cleared when the printer is powered off. Operating memory is sometimes known as working memory.

**page**

In the context of a laser printer, the image you are printing.

**parallel interface**

A data communications interface that transmits multiple bits of data (usually in 1-byte segments) simultaneously. The DEClaser 1100 printer uses a Centronics parallel interface.

**portrait printing**

A method of printing characters parallel to the short edge of the paper. This is the normal page orientation for printing. For example, this page is printed in a portrait orientation.

**PostScript language**

A programming language designed to convey a description of a desired page to a printer. It can describe a page containing any combination of text, graphical shapes, and digitized images.

**printer controller firmware**

The firmware that interprets the data in a print request according to a specified data syntax, builds bitmaps of each page to be printed, and forwards the bitmaps to the print engine, which produces the hardcopy output.

**print density**

Print density refers to the amount of toner applied to the paper to produce a lighter or darker print.

**printer software**

The software that handles the communications between the process that makes a print request (terminal), the process that provides resources (a host), and the process that performs the printing service (a print queue).

**protocol**

A procedure or set of rules that controls the communication between computers and peripherals. Also, a set of conventions between communicating processes regarding the format and contents of messages to be exchanged.

**RAM**

Abbreviation for random-access memory. RAM retains data only while power remains on. Data is cleared from RAM when the printer is powered off. The DEClaser 1100 printer contains 512 KB of built-in RAM, expandable up to 2.5 MB with optional memory boards.

**reset**

A procedure that clears data in the print buffer and returns the printer to the ready state. The printer operates using the settings stored in RAM. These settings are loaded into operating memory when a reset is performed.

**resolution**

The number of dots in a defined area. The resolution of the DEClaser 1100 printer is 300 dpi.

**ROM**

Abbreviation for read-only memory. ROM contains all of the factory default feature values. It is a permanent memory and cannot be cleared or changed.

**serial interface**

A data communications interface that transmits data sequentially, one bit at a time, at a fixed speed. The DEClaser 1100 printer uses an RS232C serial interface.

**sheet**

In the context of a laser printer, the physical piece of paper that is printed.

**simplex**

A layout indicating that a document is formatted to be printed on one side of a sheet.

**toner**

A black powder commonly known as dry ink, which is used to form the characters on the paper. Toner is contained in the EP-L cartridge on the DEClaser 1100 printer.

**type family**

A group of fonts that have a similar design, but differ in the six other font attributes. For example, Courier is a type family that resides in the DEClaser 1100 printer.

**type family ID**

A 7-character code that identifies a type family.

**xon/xoff**

A software protocol used with RS232C serial communication. It regulates the flow of data to the input buffer by exchanging on/off signals with the host computer. The xon/xoff protocol is sometimes referred to as the software handshaking protocol.

# Index

---

## A

---

Accessories and supplies, B-1  
Associated documents, xii

## B

---

Baud rate, 4-25  
Buffer control  
    DTR, 4-25  
    etx/ack, 4-26  
    xon/xoff, 4-26

## C

---

CDRH regulations, xiv  
Cleaning  
    external surfaces, 7-13  
    fixing assembly, 7-10  
COMMAND menu, 4-17  
Configuring the printer, 4-1  
Control panel, 3-1  
Control Representation Mode, 2-34,  
    2-35  
Conventions, xiii  
COPY menu, 4-17

## D

---

Data Terminal Ready (DTR), 4-25  
Document structure, x

## E

---

End of text/acknowledge (etx/ack),  
    4-26  
Envelopes  
    loading, 2-12  
    printing, 2-12

Envelopes (Cont.)

    sizes of, 5-2  
    special considerations, 5-7  
    specifications, 5-4  
EP-L cartridge  
    care of, 7-2  
    components, 1-8  
    replacing, 7-3  
Error messages  
    software, 6-6  
Error skip procedure, 6-2

## F

---

Facedown printing, 2-20  
Faceup printing, 2-22  
FEEDER menu, 4-16  
Fixing assembly  
    cleaning, 7-10  
Font List, 2-32

## I

---

INITIAL menu, 4-18  
Interface menu, 4-26  
INTERFACE menu, 4-23  
Interface selection, 4-25  
Interface specifications  
    parallel, C-6  
    serial, C-4

## K

---

Keypad, 3-3  
    in Keypad Mode, 3-5  
    in Menu Mode, 3-8, 4-3

## L

---

- Labels
  - special considerations, 5–10
  - specifications, 5–9
- Laser safety, xiv
- LAYOUT menu, 4–16
- LN03 compatibility, D–1

## M

---

- Macro feature, 4–19
  - examples, 4–21
- Maintenance, 7–1
- Media sizes, 2–6
- Memory
  - nonvolatile random-access, 4–9
  - operating, 4–7
  - random-access, 4–10
  - read-only, 4–8
- Menu
  - COMMAND, 4–17
  - COPY, 4–17
  - FEEDER, 4–16
  - INITIAL, 4–18
  - INTERFACE, 4–23
  - LAYOUT, 4–16
- Menu descriptions, 4–14
- Menu Mode, 4–2 to 4–3
  - changing and saving values, 4–12
  - operational flow, 4–10
- Menu Mode display, 4–4 to 4–6
- Messages
  - operator call, 6–4
  - printer status, 6–3
  - service call, 6–8
  - software error, 6–6

## N

---

- Nonvolatile random-access memory, 4–9
- NVRAM, 4–9

## O

---

- Operating memory, 4–7
- Operating problems, common, 6–8
- Operating space, 1–9
- Operating specifications, C–1
- Operational flow in Menu Mode, 4–10
- Operator call messages, 6–4
- Ordering documentation, xi
- Ordering information, B–3
- Output tray selection, 2–18
  - front output tray, 2–22
  - top output tray, 2–20

## P

---

- Paint Mode, 4–22
- Paper
  - handling, 5–11
  - loading, 2–6
  - special considerations, 5–3
  - specifications, 5–2
  - storing, 5–11
- Paper jams, 6–12
  - cassette, 6–22
  - printer, 6–14
- Paper tray
  - loading envelopes, 2–12
  - loading paper, 2–7
  - opening, 2–4
- Power off, 2–3
- Power on, 2–1
- Print density adjustment, 2–24
- Printer
  - cleaning, 7–13
  - components and functions, 1–1, 1–6, 1–8
  - resetting, 2–36
- Printer configuration memory, 4–6 to 4–10
- Print media, 5–1

## Q

---

- Quick Reference Guide, A–1



## Quick Reference Guide (Cont.)

- control characters, A-17
- fonts and character sets, A-11
- margins and spacing, A-5
- miscellaneous, A-18
- positioning controls, A-2
- set/reset modes, A-10

## R

---

- RAM, 4-10
- Random-access memory, 4-10
- Read-only memory, 4-8
- Replacement procedures
  - EP-L cartridge, 7-3
- Resetting the printer, 2-36
- ROM, 4-8
- RS232C data format, 4-25

## S

---

- Safety information, xiv
- Service, 8-1
- Service call messages, 6-8
- Setup menus, 4-1
- Software requirements, x
- Specifications
  - envelopes, 5-4
  - labels, 5-9
  - operating, C-1
  - paper, 5-2
  - transparencies, 5-8
- Status messages, 6-3

## T

---

- Test Print A, 2-27
- Test Print B, 2-30
- Transparencies
  - special considerations, 5-8
  - specifications, 5-8
- Troubleshooting, 6-1

## V

---

- Values

## Values (Cont.)

- changing and saving procedure,  
4-12

## X

---

- xon/xoff, 4-26