



VRC21-Hx Multi-Scanning Digital Control Color Monitor

Installation and Operating Information

Order Number: EK-VRC21-HX. B01

Important Warnings Inside

January 1994

The information in this document is subject to change without notice and should not be construed as a commitment by Digital Equipment Corporation.

Restricted Rights: Use, duplication, or disclosure by the U.S. Government is subject to restrictions as set forth in subparagraph (c) (1) (ii) of the Rights in Technical Data and Computer Software clause at DFARS 252.227-7013.

FCC ID: A09-VRC21

Note: This equipment has been tested and found to comply with the limits for a Class B digital device, pursuant to Part 15 of the FCC rules. These limits are designed to provide reasonable protection against harmful interference in a residential installation. Any changes or modifications made to this equipment may void the user's authority to operate this equipment.

This equipment generates, uses, and can radiate radio frequency energy and, if not installed and used in accordance with the instructions, may cause harmful interference to radio and television reception; however, there is no guarantee that interference will not occur in a particular installation. If this equipment does cause harmful interference to radio or television reception, which can be determined by turning the equipment off and on, the user is encouraged to try to correct the interference by one or more of the following measures:

- Re-orient or relocate the receiving antenna.
- Increase the separation between the equipment and the receiver.
- Connect the equipment to an outlet on a circuit different from that to which the receiver is connected.
- Consult the dealer or an experienced radio/TV technician for help.

The video input to this device is through the 5 BNC connectors located at the rear of the device. The optional 15-pin D sub-miniature connector at the rear of the device is not a supported option and shall not be connected to any cable at the same time as the 5 BNC connectors are connected to cables, as this will cause video quality degradation, and may cause increased levels of radio frequency interference.

There are no user serviceable parts inside. Do not attempt to modify this equipment. If modified, your authority to operate this equipment might be voided by the FCC.

Canadian Department of Communications (DOC) Statement

This digital apparatus does not exceed the Class B limits for radio noise emissions from digital apparatus as set out in the radio interference regulations of the Canadian Department of Communications.

DEC and the DIGITAL logo are trademarks of Digital Equipment Corporation. The Energy Star emblem does not represent EPA endorsement of any product or service.

Copyright © Digital Equipment Corporation 1994.
All rights reserved.
Printed in Japan.

Contents

About This Guide	v
1 Installation	
1.1 Monitor Installation	1-1
1.2 Turn On Power to Monitor	1-3
2 Servicing	
2.1 Cleaning the Monitor	2-1
2.2 Maintenance and Troubleshooting	2-1
2.2.1 Identifying and Correcting Problems	2-1
2.2.2 Troubleshooting Table	2-2
2.3 Adjustment Mode	2-4
2.3.1 Adjustment Codes	2-4
2.3.2 Horizontal position (phase) control	2-5
2.3.3 Horizontal size control	2-5
2.3.4 Vertical position control	2-5
2.3.5 Vertical size control	2-5
2.3.6 Color 1	2-5
2.3.7 Color 2	2-5
2.3.8 Color 3 control	2-6
2.3.9 Color 3 (Green gain) control	2-6
2.3.10 Color 3 (Blue gain) control	2-6
2.3.11 Color 3 (Red gain) control	2-6
2.3.12 Rotation control	2-6
2.3.13 PCC-Amp-Fine control	2-6
2.3.14 PCC-Amp control	2-6

2.3.15	PCC-Phase control	2-7
2.3.16	Key-Balance control	2-7
2.3.17	Pin-Balance control	2-7
2.4	Servicing the Monitor	2-7
2.4.1	DECmailer	2-8
2.4.2	Carry-In Service	2-8
2.4.3	Monitor Disposal	2-8

3 Specifications

3.1	Monitor Specifications	3-1
3.2	Scanning Modes	3-2
3.3	Monitor Power Management System	3-3
3.4	Environment	3-4

Figures

1-1	VRC21-Hx Color Monitor (Rear View)	1-2
1-2	VRC21-Hx Color Monitor (Front View) ...	1-3
2-1	Adjustment Controls	2-4

Tables

1	Recommendations for Proper Setup and Use	viii
1-1	User Controls and Functions	1-3
2-1	Identifying and Correcting Problems	2-2
3-1	Factory Pre-set Resolution and Frequencies	3-2

About This Guide

Overview

The VRC21-Hx Color Display Monitor is a 21-inch intelligent, microprocessor based monitor with multiscanning and digital-controlled color graphics. The monitor is compatible with most red-green-blue (RGB) display standards and color video cards. The digital-controlled multiscanning allows the monitor to operate with precision regardless of its input power frequency.



The monitor is well-suited for windowing environments. Within the its memory, you can store pre-programmed screen display standards, as well as your selection of display colors from an unlimited palette.

The monitor also has a power management system, which a personal computer can control to reduce the monitor's output power levels while not in use, thus saving energy. This power management system exceeds the U.S. Environmental Protection Agency (EPA) Energy Star requirements for saving energy.

Audience

This guide is intended for users who wish to install the color monitor. This guide describes how to connect cables and clean the monitor.

Conventions

The following conventions are used in this document:

Convention	Meaning
Note	Provides general information.
Caution	Provides information to prevent damage to equipment.
Warning	Provides information to prevent injury.

Environment

Note

This product has been designed and manufactured to minimize the impact to the environment. The packaging is recyclable and the monitor can be returned for proper disposal.

Before You Start

A small flat-blade screwdriver may be needed to install the communication cable.

Proper Setup and Use

Important Information

Certain recent scientific literature suggests that poor posture, work habits, or office equipment setup may cause injuries. Other literature suggests that there is no cause and effect. Because the safety of our users is a great concern, it is important to take the precautions described in Table 1.

Table 1 Recommendations for Proper Setup and Use

Adjust	So that . . .
Chair	1 Feet are flat on the floor or footrest if needed.
	2 Legs are vertical forming a right angle to the floor.
	3 Your weight is off your thighs and are in a horizontal position. Keep the back of your knees away from the seat so you do not compress the area behind them, which could restrict the blood flow.
	4 Your upper body is erect and your lower back is supported with a backrest.
Keyboard	5 Your wrists are straight and do not flex more than 15°. They may be supported but should not rest on sharp edges.

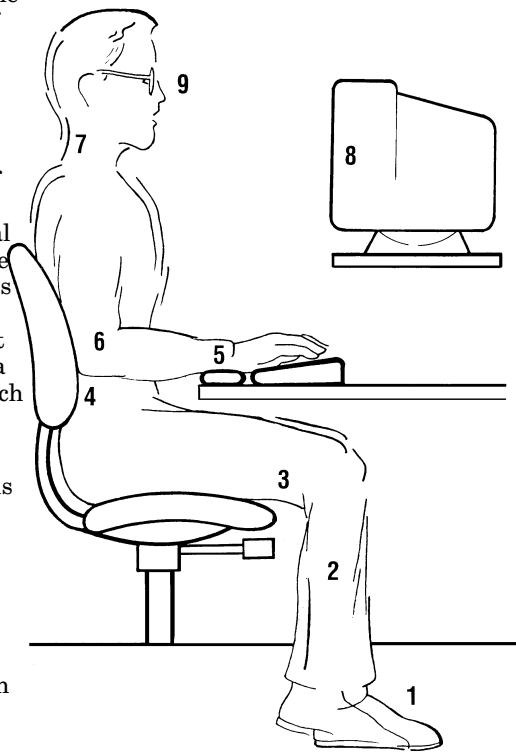

MA-0069-93.IL

(continued on next page)

Table 1 (Cont.) Recommendations for Proper Setup and Use

Adjust	So that . . .
Arms	6 Your upper arms are straight down at your sides, and elbows are close to your sides and support your arm weight. Forearms should be at a 70° to 90° angle.
Head	7 Your neck is not strained. Your head should incline downward, but no more than 15° to 20°.
Monitor	8 Your eye level is at the correct distance for proper vision.
Eyes	9 You avoid eyes fatigue, which can be caused by glare, image quality, uncomfortable furniture, eye height, and uncorrected vision. If you cannot read the screen at different distances, you may need special glasses. Relax your eyes periodically by looking at distant objects.
Work Breaks	You take periodic work breaks. Morning, lunch, and afternoon breaks meet most recommendations. Take advantage of work breaks to move around and do other movements.
Lighting	You avoid direct lighting or sunlight on the screen, which causes glare and reflections. This monitor screen has an antiglare treatment to reduce glare. Place lighting behind or to the side of your work area, and distribute the lighting evenly on your work area. Adjust the brightness and the contrast controls as needed.
Noise	You keep background noise at a minimum. Background noise above 65 dBA is tiring. Sound-absorbing materials, such as curtains, carpeting, and acoustic tile, can help reduce background noise.
Temperature	The room is 20°C to 23 °C (68°F to 74°F)
Humidity	The air is 30% to 70% relative humidity.
Ventilation	There is adequate air ventilation for equipment operation and to avoid fatigue.

(continued on next page)

Table 1 (Cont.) Recommendations for Proper Setup and Use

Adjust	So that . . .
Space between monitors	There is more than 70 cm (28 in) center to center, preferably more than 152 cm (60 in).

Warning

If you experience pain or discomfort during use of the monitor, then take a substantial break and review the instructions for posture and work habits. If the pain or discomfort continues after resuming use of the monitor, then discontinue use and report the condition to your job supervisor or physician.

Installation/Operating Guidelines

Observe the following basic rules for installation and use.

Do . . .

- Use the power cord supplied with the monitor, which is UL-, CSA-, and VDE-approved.
- Turn the monitor off when not being used for an extended period of time.

Do Not . . .

- Overload the ac outlet.
- Open the monitor. It contains high voltages that could result in personal injury. If any problems arise, call your service technician.
- Move the monitor on a stand over carpet or thresholds.
- Push objects into the monitor's openings.
- Add accessories that are not designed for this monitor.
- Operate the monitor near water or in a damp environment, which could cause an electrical shock hazard.
- Operate the monitor near magnets, motor devices, transformers, high power lines, or large steel pillars, which can cause distortion in the picture and/or color purity.
- Obstruct the ventilation openings in the monitor's cabinet, such as placing the monitor on a rug or within an enclosure.
- Place the monitor near a radiator or heat source.

1

Installation

1.1 Monitor Installation

To connect your monitor:

1. Make sure the power to the monitor and the computer is off.
2. Position the monitor and the computer so that you can easily get to the back panel of each system.
3. Connect the BNC connectors of the cable to the R G B inputs ❷ on the back of the monitor.
4. Connect the other end of the cable to the High Resolution Graphic Video Card or to the back of the personal computer. If needed, refer to your computer owner's manual.
5. If your cable has a separate sync signals, connect these BNC connectors to their respective BNC receptacles (HD/COMP ❸ and VD ❹) on the back of the monitor. However, if sync on green is available, do not connect the HD/COMP and VD BNC cables.

Installation

1.1 Monitor Installation

Figure 1–1 VRC21-Hx Color Monitor (Rear View)

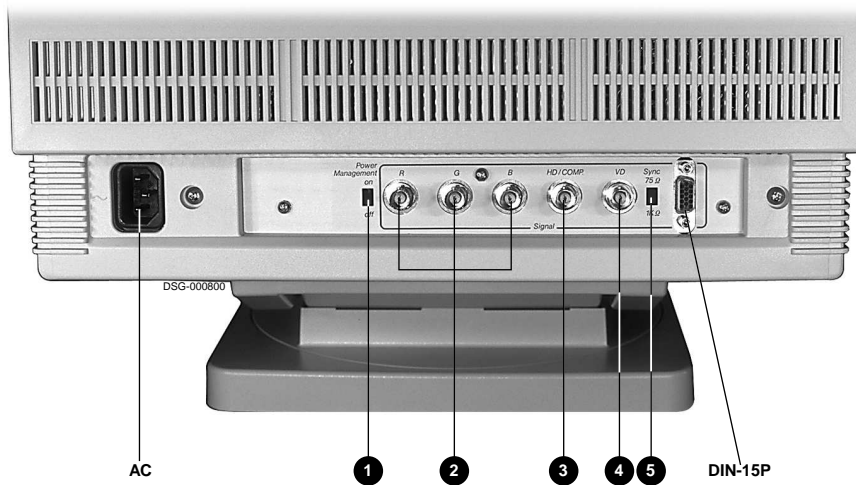

6. Ensure that the Sync switch **5** is set at 75Ω . (The $1k\Omega$ position is for TTL sync signals on DIN-15P, which is not supported.)
7. If desired, set the Power management switch **1** On. This switch allows the monitor's power supply to reduce its output when given the correct signal from a PC that has a Power Management feature.
8. Plug in the ac power cord to the monitor, then to a properly-grounded ac electrical outlet.

Installation
1.2 Turn On Power to Monitor

1.2 Turn On Power to Monitor

Push the power switch button **1** to turn on the monitor. The power indicator **2** should light.

Figure 1–2 VRC21-Hx Color Monitor (Front View)

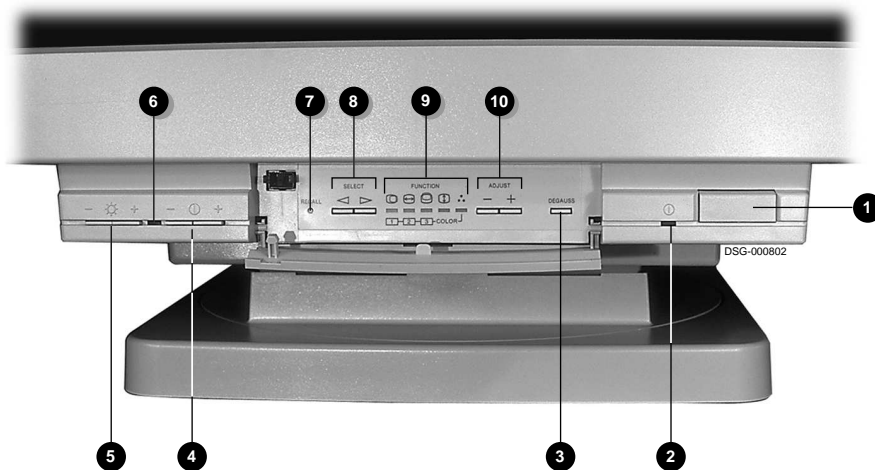

Table 1–1 User Controls and Functions

Item	Function
1 Power switch	Turns the monitor on and off
2 Power indicator	Lights when ac power is on.
3 Degaussing switch	Eliminates possible color impurity.
4 Contrast	Increases (+) or decreases (-) white level for comfortable viewing.
5 Brightness	Adjusts black level for comfortable viewing

(continued on next page)

Installation

1.2 Turn On Power to Monitor

Table 1–1 (Cont.) User Controls and Functions

Item	Function
⑥ Status indicator	<ul style="list-style-type: none">• Lights when adjusting Contrast or Brightness.• Flashes when limits are reached.• Flashes when sync signal is not connected.• Blinks slowly when power management is active.
⑦ Memory recall button	Restores factory default adjustments.
⑧ Adjustment function select buttons	Selects the desired adjustment function.
⑨ Adjustment function indicators	Identifies the selected function.
⑩ Adjustment controls [-] and [+]	Decreases or increases the function adjustment, which is automatically saved in memory.
With any of the following selected . . .	Pushing Memory Recall button ⑦ restores . . .
H-Position, H-Size, V-Position, V-Size	Screen position and size
Color 3 gain	Color for all gains
Rotation control and both [+] and [-] adjustments at the same time	Rotational adjustment

2

Servicing

2.1 Cleaning the Monitor

To clean the monitor:

1. Unplug the monitor.
2. Clean the monitor with a soft, slightly damp cloth. **Do not** use an aerosol cleaner directly on the screen.

Caution

Do not use benzene, thinner, or any volatile substance to clean the monitor, as these product may discolor the monitor's cabinet. Likewise, do not place rubber or vinyl on the monitor.

2.2 Maintenance and Troubleshooting

2.2.1 Identifying and Correcting Problems

The following can be sources of problems:

- Communications cables
- Host system
- Nearby power or electrical sources

Servicing
2.2 Maintenance and Troubleshooting

2.2.2 Troubleshooting Table

Use Table 2–1 to identify and correct any problem areas.

Table 2–1 Identifying and Correcting Problems

Symptom	Possible Cause	Suggested Solution
Display does not appear.	Brightness or Contrast control is set too low.	Increase the brightness and contrast control setting
	Power Management feature is active in off state.	Turn the monitor off, then on again.
	Power cord is not connected.	Connect the power cord to the power source and the monitor. Push the power switch in.
	There is no power.	Use a functional outlet.
	The monitor could be faulty.	Press the memory recall button under the front of the monitor. Set the power switch to the off position and contact the service representative.
Screen is blank, but green LED is blinking slowly.	Power Management feature is active in standby state.	Press any key on the keyboard.
	Sync signal is lost.	Check connections for cables to the monitor and the source.

(continued on next page)

Servicing 2.2 Maintenance and Troubleshooting

Table 2–1 (Cont.) Identifying and Correcting Problems

Symptom	Possible Cause	Suggested Solution
	The Power Management feature is active on monitor but not supported on host.	Turn it OFF.
Display is too dim or too bright.	Brightness or Contrast control not set correctly.	Adjust the brightness and contrast control setting.
Background raster is too bright and cannot be adjusted.	Synchronization signals may be present on both the green cable and the horizontal and vertical sync cables.	Disconnect the horizontal and vertical sync cables (HD/COMP and VD) from the back of the monitor.
Buzzing sound when monitor is turned on lasting less than 5 s.	The auto degaussing circuit is active.	This is normal.
Video is off center.	The Earth's magnetic field at your location may be causing the display to shift.	Use the function controls under the front panel to adjust your screen to to eliminate the distortion. See Section 2.3.
Video display has moving dots and distorted lines. The display rolls or flickers.	There is electromagnetic interference.	Move any electromechanical device, such as a fan or a motor, away from the monitor or move the monitor.

Servicing
2.3 Adjustment Mode

2.3 Adjustment Mode

Monitors are sensitive to magnetic influences in the environment. The adjustment mode lets you change several aspects of the monitor to stabilize the video image in your area.

2.3.1 Adjustment Codes

1. Press the select buttons (< >) to choose one of the controls indicated in Figure 2-1. The selections cycle through the controls in the same sequence listed in the table.

Figure 2-1 Adjustment Controls¹

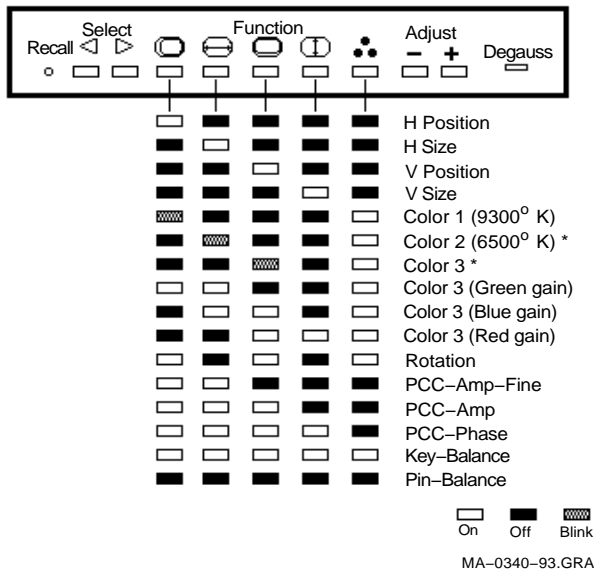

2. When the indicator above the function symbol lights up, the control is active and can be adjusted. Press the or buttons to decrease or increase the adjustment. The monitor automatically memorizes all adjustments.

¹ *When on Color 1, press the or buttons to obtain Color 2 and Color 3.

2.3 Adjustment Mode

2.3.2 Horizontal position (phase) control

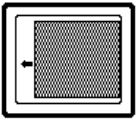

Moves the horizontal position to the left (-) or right (+).

2.3.3 Horizontal size control

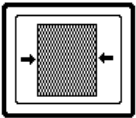

Narrows (-) or widens (+) the image.

2.3.4 Vertical position control

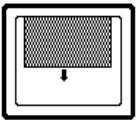

Moves the image down (-) or up (+).

2.3.5 Vertical size control

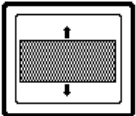

Shrinks (-) or expands (+) the height of the image.

2.3.6 Color 1

Factory preset to 9300°K white temperature.

2.3.7 Color 2

Factory preset to 6500°K white temperature.

Servicing

2.3 Adjustment Mode

2.3.8 Color 3 control

Adjusts the white color balance. *Default: 9300°K.*

2.3.9 Color 3 (Green gain) control

Decreases (-) or increases (+) the green color gain.

2.3.10 Color 3 (Blue gain) control

Decreases (-) or increases (+) the blue color gain.

2.3.11 Color 3 (Red gain) control

Decreases (-) or increases (+) the red color gain.

2.3.12 Rotation control

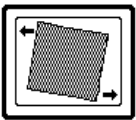

Rotates the image counterclockwise (-) or clockwise (+).

2.3.13 PCC-Amp-Fine control

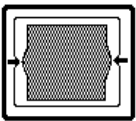

Narrows (-) or widens (+) the center of the image on the screen.

2.3.14 PCC-Amp control

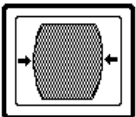

Corrects a bowed image by narrowing (-) or widening (+) the left and right edges.

Servicing 2.3 Adjustment Mode

2.3.15 PCC-Phase control

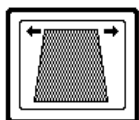

Corrects a trapezoid image by narrowing (-) the top or bottom (+) of the image.

2.3.16 Key-Balance control

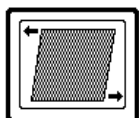

Corrects a slanted image by moving the top of the image left (-) or right (+).

2.3.17 Pin-Balance control

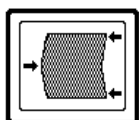

Corrects a distorted image by moving the center of the image left (-) or right (+).

2.4 Servicing the Monitor

Warning

Do not attempt to service the monitor yourself. It contains hazardous high voltages. Call a qualified service representative.

Digital provides a wide range of maintenance programs for monitors. It is recommended that you use either DECmailer or Carry-In Service when servicing the VRC21-Hx color monitor. If needed, use the original box and packing material to send the unit to the service location. Contact your local Digital Services office.

Servicing

2.4 Servicing the Monitor

2.4.1 DECmailer

DECmailer provides a mail-in service for the VRC21-Hx color monitor. Ship the monitor to your nearest Digital Servicenter using a common carrier. The monitor will be repaired or exchanged and returned to you.

2.4.2 Carry-In Service

Digital Carry-In Servicenters are located in major cities around the world. They offer convenient, cost-effective repair service with a 48-hour turnaround time.

2.4.3 Monitor Disposal

Warning

If you need to dispose of a unit, ask a qualified service representative for the proper procedure. Improper disposal could result in personal injury from implosion.

3

Specifications

3.1 Monitor Specifications

Monitor	53.4 cm (21 in) non-glare, non-static 90° deflection, 0.31 mm stripe pitch
Dimensions	49.4 × 49.3 × 54.3 cm
Display size	380 × 285 mm; 4:3 ratio 356 × 285 mm; 5:4 ratio
Color	1=9300°K, 2=6550°K, 3=9300°K
Swivel	±45°
Tilt	-5° to +10°
Weight	36 Kg (79.5 lb)
Video Signal	0.7V p-p RGB, with sync on green, composite, or separate H- and V-sync.
Connectors	BNC; 15-pin D-sub (not supported, do not use)
Power input	Autoranging: 100 - 120 Vac, 1.5 A; 220 - 240 Vac, 0.7 A; 50 Hz or 60 Hz
Environment:	
Operating Temperature	5 - 40°C
Humidity	10 - 95% relative humidity (noncondensing)

Specifications

3.2 Scanning Modes

3.2 Scanning Modes

To minimize adjustment needs, the monitor has 12 factory pre-set display standards, shown in Table 3–1. When the monitor detects any of these display standards, it automatically adjusts the picture size and centering.

Table 3–1 Factory Pre-set Resolution and Frequencies

Pre-set Addressability	Vertical*	Horizontal
640 x 480 (VGA)	59.94	31.47
640 x 480 (ERGO VGA)	72.79	37.86
720 x 400	70.08‡	31.47‡
800 x 600 (ERGO SVGA)	72.19†	48.08†
1152 x 900	76.15	71.81
1024 x 768	72.00	57.38
1024 x 864	60.00	54.05
1280 x 1024	60.10	64.98
1280 x 1024	66.47	70.66
1280 x 1024	72.56	77.17
1152 x 900	66.00	61.85
1280 x 512 (Stereo)	139.32	76.76

Using the monitor's controls, you may store up to 10 additional display standards. They must differ from any existing display standards by at least 2kHz horizontal scan frequency or 10 Hz vertical scan frequency, or the sync signal polarities must be different. One of these is set as:

800 x 600 (SVGA)	60.32†	37.88†
------------------	--------	--------

Note: If you erase/modify these values, Memory Recall does not restore them.

*non-interlaced

†positive polarities

‡Negative H Sync; positive V Sync

Specifications
3.3 Monitor Power Management System

3.3 Monitor Power Management System

This monitor has three power-saving states, indicated by the light-emitting diode (LED) on the front panel:

Screen	Green LED	State	Power Consumption†	Recovery Time
On	Off (On if sync signal is missing)	Not used	150 w (max)	-
Off	Blinks slowly	Standby/ Suspend	< 30 watts	2 s
Off	Off	Off	< 5 watts	15 s after the monitor is switched off then on again.

† These power-saving states exceed the Environmental Protection Agency (EPA) Energy Star requirements using the Video Electronics Standard Association (VESA) methodology for Display Power Management Signals.

Notes

1. For proper operation of this Monitor Power Management System, make sure that the monitor signal cable is connected to the host system and that the host system is On.
 2. The power to the monitor may be On, indicated by the power switch being recessed, even when the LED is Off. When not in use for extended periods, turn the monitor Off. This reduces the power consumption to a minimum.
-

Specifications

3.4 Environment

3.4 Environment

This product has been designed and manufactured to minimize the impact to the environment. The packaging is recyclable and the monitor can be returned for proper disposal.

Acoustic Levels

Preliminary declared values per ISO 9296 and ISO 7779:

Product	Sound Power Level ¹		Sound Pressure Level ²	
	L _{w Ad} , B		L _{p Am} , dBA	
	Idle	Operate	Idle	Operate
VRC21-Hx	<4.0	<4.0	<35	<35

¹1 B = 10 dBA.

²Operator position.

Asbestos

This product does not use asbestos in any form.

Flame Retardants

The enclosures do not contain polybrominated diphenylether (PBDE) as a flame retardant additive; therefore, they do not emit toxic dibenzofuran and dibenzodioxin gases.

Ozone Depleting Substances (ODS)

The VRC21-Hx is in full compliance with the labeling requirements in the U.S. Clean Air Act Amendments of 1990. It does not contain, nor is it manufactured with, a Class 1 ODS, as defined in Title VI Section 611 of this act.

PVC

The plastic enclosures are not made of rigid PVC. The material has a non-halogenated, flame-retardant system and is cadmium free.

Specifications

3.4 Environment

Recyclable Material

The packaging material can be recycled, or you can save it to return the monitor to a service center for repair or disposal.

VCCI Class 2

この装置は、第二種情報装置(住宅地域又はその隣接した地域において使用されるべき情報装置)で住宅地域での電波障害防止を目的とした情報処理装置等電波障害自主規制協議会(VCCI)基準に適合しております。しかし、本装置をラジオ、テレビジョン受信機に近接してご使用になると受信障害の原因となることがあります。取扱説明書に従って正しい取り扱いをして下さい。

DSG-000324

