

DECrepeater 90FA

Owner's Manual

Order Number: EK-DEFAR-OM. B01

Revision/Update Information: This is a revised manual.

First Edition, September 1992
Second Edition, January 1994

Possession, use, or copying of the software described in this publication is authorized only pursuant to a valid written license from Digital or an authorized sublicensor.

Digital Equipment Corporation makes no representations that the use of its products in the manner described in this publication will not infringe on existing or future patent rights, nor do the descriptions contained in this publication imply the granting of licenses to make, use, or sell equipment or software in accordance with the description.

Restricted Rights: Use, duplication, or disclosure by the U.S. Government is subject to restrictions as set forth in subparagraph (c) (1) (ii) of the Rights in Technical Data and Computer Software clause at DFARS 252.227-7013.

© Digital Equipment Corporation 1992, 1994. All rights reserved.

FCC NOTICE: The equipment described in this manual generates, uses, and may emit radio frequency energy. The equipment has been type tested and found to comply with the limits for a Class A computing device pursuant to Subpart J of Part 15 of FCC Rules, which are designed to provide reasonable protection against such radio frequency interference when operated in a commercial environment. Operation of this equipment in a residential area may cause interference, in which case the user at his own expense may be required to take measures to correct the interference.

The following are trademarks of Digital Equipment Corporation: BI, DEC, DECbridge, DECconnect, DECMCC, DECnet, DECserver, Digital, LAT, MicroVAX, ThinWire, ULTRIX, UNIBUS, VAX, VAX-11/780, VAX-11/785, VAX 3600, VAX 3900, VAX 6000, VAX 6300, VAX 6400, VAX 9000, VAXcluster, VAX DOCUMENT, VAXELN, VAXstation, VMS, VT, and the DIGITAL logo.

ST is a registered trademark of American Telephone & Telegraph Company.

All other trademarks and registered trademarks are the property of their respective holders.

This document was prepared using VAX DOCUMENT Version 2.1.

Contents

About This Manual	vii
1 Overview	
Features	1-1
LEDs and Connectors	1-2
2 Configuring the DECrepeater 90FA	
Configuration Rules	2-1
Segment Length Constraints	2-1
Network Constraints	2-2
Installed Fiber Constraints	2-5
3 Installation	
Site Considerations	3-1
Standalone Installation	3-1
Mount the DECrepeater 90FA on a Wall	3-2
Standalone Installation Connections	3-4
Backplane Installation	3-6
4 Managing the DECrepeater 90FA	
Functions	4-1
Components Needed	4-1
Accessing MOP from VMS Systems	4-2
Accessing a Bridge Repeatedly	4-3
Accessing MOP from ULTRIX Systems	4-3
Console Carrier User Interface	4-4
Console Carrier Command Language	4-4
Description of Command Parameters	4-6
Description of Commands	4-7

Typical Management Techniques	4-13
Remote Network Management with the DECbridge 90	4-14
Management Disconnect	4-14
Management Session	4-15
Example of a Typical Management Session	4-15
If Problems are Reported	4-16
To Disable a Port	4-17
To Reset the Repeater	4-17
Error Messages	4-18
Standalone Configuration Management	4-20

5 Troubleshooting

Port Partitioning	5-1
DECrepeater 90FA Standalone Troubleshooting	5-3
DECrepeater 90FA Backplane Troubleshooting	5-8

A Specifications and Parts List

AUI Connector Pin Assignments	A-4
Parts List	A-5

B Management Details

Designating a Hub Manager	B-1
Annotating the Bridge Address Table	B-2
Using the WGB Address Table for Work Group Management	B-3

C Related Documentation

Ordering Information	C-1
Continental USA and Puerto Rico	C-1
New Hampshire, Alaska, and Hawaii	C-1
Outside the USA and Puerto Rico	C-1
Digital Personnel	C-2

Index

Figures

1-1	DECrepeater 90FA LEDs and Connectors	1-2
2-1	DECrepeater 90FA Repeater Path	2-3
2-2	DECrepeater 90FA Typical DEChub 90 Configuration	2-4
3-1	Removing the Back Cover	3-2
3-2	Mounting Screws	3-3
3-3	Standalone Installation	3-5
3-4	Installing the DECrepeater 90FA into the DEChub 90	3-7
4-1	Sample Configuration	4-13
4-2	Typical Network Topology Map	4-15

Tables

1-1	DECrepeater 90FA LEDs and Connectors	1-3
2-1	Segment Lengths	2-1
4-1	Ethernet Circuit Names for Systems	4-2
4-2	Summary of DECbridge 90FA Commands	4-5
4-3	DECbridge 90 Messages	4-18
5-1	DECrepeater 90FA Status Indicators	5-2
5-2	DECrepeater 90FA Fiber-Link Indicators	5-2
5-3	Troubleshooting a DECrepeater 90FA Standalone Unit	5-3
5-4	Troubleshooting a DECrepeater 90FA in a DEChub 90 Backplane	5-8
A-1	Physical Dimensions	A-1
A-2	Operating Environment	A-2
A-3	Shipping Environment	A-2
A-4	Power Specifications	A-3
A-5	DECrepeater 90FA Input	A-3
A-6	Parts List	A-5

About This Manual

This manual describes how to install, operate, and maintain the DECRepeater 90FA repeater. The DECRepeater 90FA is a three-port repeater designed to function as a standalone unit or as a managed unit in a DEChub 90 backplane.

In this manual, the DECRepeater 90FA unit may be referred to as the *DECRepeater 90FA* or the *repeater*.

Organization

This manual contains five chapters and three appendices.

Chapter	Description
1	Provides an overview of the DECRepeater 90FA and briefly describes the product's features.
2	Describes the configuration rules and conditions of operation for the DECRepeater 90FA in a ThinWire Ethernet system or fiber-optic network.
3	Describes how to install the DECRepeater 90FA.
4	Describes how to manage the DECRepeater 90FA.
5	Provides basic troubleshooting information.
Appendix A	Provides the physical dimensions, environmental (operating and shipping) specifications, electrical specifications, and a parts list.
Appendix B	Provides more detailed information on management issues.
Appendix C	Provides a list of related documentation and ordering information.

Conventions

The following conventions are used in this manual:

Convention	Meaning
Note	Provides general information.
❶	A number in a black circle in text refers to the corresponding number in an accompanying figure.
[]	In command descriptions, brackets indicate optional elements.
<i>variables</i>	In command descriptions, italic type indicates a variable that you supply.
SHOW ADDRESS	In text, commands are shown in all uppercase letters to differentiate them from regular text. For VMS operating systems, you can enter commands in either uppercase or lowercase letters. For ULTRIX operating systems, commands must be entered as indicated in the examples.
DECbridge>	Text that the system displays on the screen is shown in monospaced type.
SHOW REPEATER 1	Text that you enter is shown in bold monospaced type.

1

Overview

This chapter describes the DECRepeater 90FA repeater and briefly summarizes the features of this repeater.

The DECRepeater 90FA is a three-port repeater designed for IEEE 802.3 standard CSMA/CD networks. The DECRepeater 90FA has one ThinWire port, one fiber-optic port, and one 15-pin AUI port. The ThinWire port complies with the IEEE 802.3 standard for 10Base2 networks; the fiber-optic port complies with the IEEE 802.3 standard for 10Base-FL networks; and the AUI port complies with the IEEE 802.3 standard for Attachment Unit Interfaces. The 10Base-FL standard allows backward compatibility of the DECRepeater 90FA to Fiber Optic Inter Repeater Link (FOIRL) compliant products.

The DECRepeater 90FA can operate in a standalone configuration or as a managed repeater when installed in a DEChub 90 backplane with a DECbridge 90 series bridge.

When operating as a standalone unit, the DECRepeater 90FA is an unmanaged repeater with a separate power supply connected to the repeater by a cable with a 7-pin connector. The auto-ranging power supply is modular and accommodates either a North American 120-volt or an international 240-volt wall outlet.

Features

The following list summarizes the main features of the DECRepeater 90FA:

- One ThinWire (10Base2) port
- One fiber-optic link (10Base-FL) port
- One 15-pin AUI Ethernet port
- Standalone or installable in a DEChub 90 backplane
- Manageable when installed in a DEChub 90 backplane

For detailed information about how to configure the DECRepeater 90FA, see Chapter 2, Configuring the DECRepeater 90FA. For detailed information about how to install and use the DECRepeater 90FA, see Chapter 3, Installation.

LEDs and Connectors





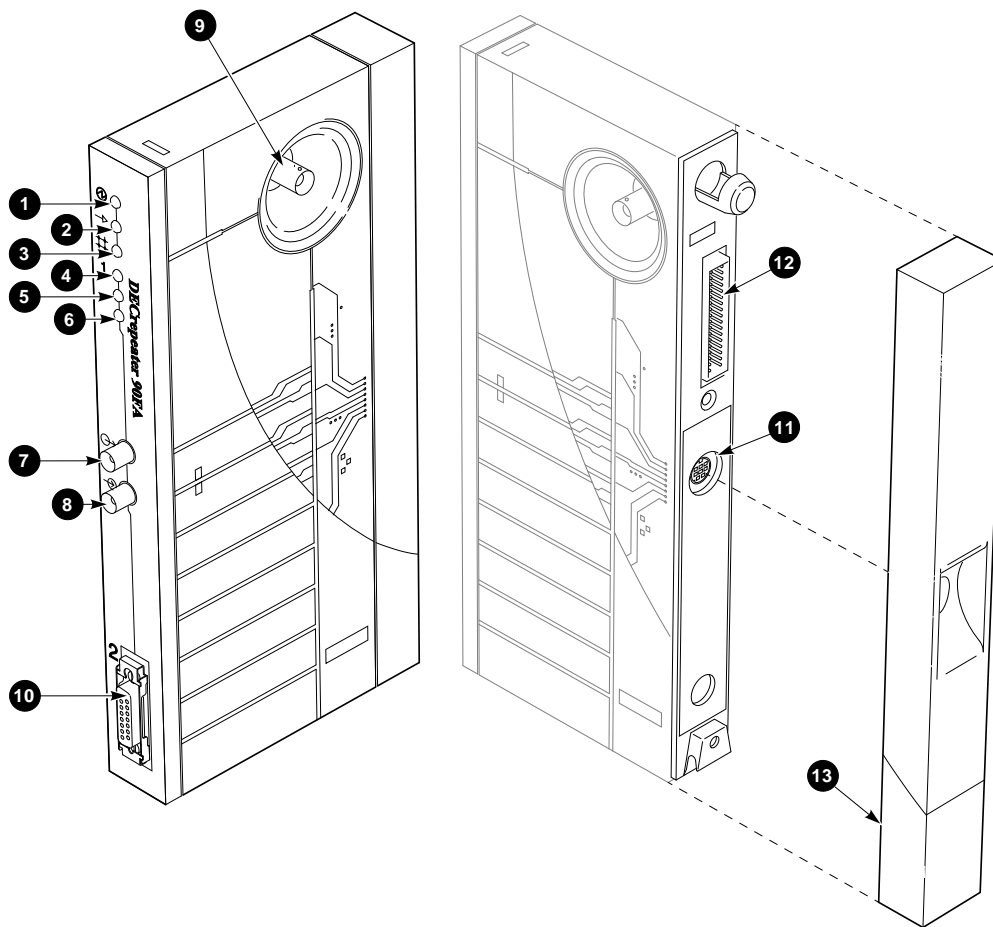

The front panel of the DECrepeater 90FA contains several indicator lights (LEDs) and connectors. These LEDs and connectors are described in Table 1-1 and are shown in Figure 1-1.

Figure 1-1 DECrepeater 90FA LEDs and Connectors



LJ-02371-T10

Table 1–1 DECrepeater 90FA LEDs and Connectors

1		<p>DC OK monitors the voltage. On: The +5.0 Vdc and +12.0 Vdc voltage is normal. Off: The voltage is abnormal (as when a power failure occurs).</p>
2		<p>Network activity indicator monitors the network activity. On: There is network activity. Off: There is no network activity.</p>
3		<p>Port 0 status indicator monitors the status of port 0. On: Port 0 is functional. Off: Port 0 is not functioning or has been partitioned. Flashing: Port 0 has been partitioned by management.</p>
4		<p>Port 1 status indicator monitors the status of port 1. See Table 5–1 in Chapter 5, Troubleshooting, for more information. On: Port 1 is functional. Off: Port 1 is not functioning or has been partitioned. Flashing: Port 1 has been partitioned by management.</p>
5		<p>Fiber-link status indicator monitors the optical link status of port 1. See Table 5–2 in Chapter 5, for more information. On: The link is operational. Off: The link is not functioning.</p>
6		<p>Port 2 AUI status indicator monitors the status of port 2. On: The port is operational. Off: The port is not functioning. Flashing: The port has been partitioned by management.</p>
7		<p>Fiber-optic transmit connector connects to the receive port of the other fiber-optic device.</p>
8		<p>Fiber-optic receive connector connects to the transmit port of the other fiber-optic device.</p>
9		<p>Port 0 network connector (BNC) connects the repeater to the work group ThinWire segment. Not used when the repeater is installed in the DEChub 90 backplane.</p>
10		<p>Port 2 Backbone Port AUI connector provides AUI connection to the backbone port of the DECrepeater 90FA.</p>
11		<p>Power connector receives +5.0 V and +12.0 V from the DECrepeater 90FA power supply. Not used when the repeater is installed in the DEChub 90 backplane.</p>
12		<p>Backplane connector provides network and power connections to the DECrepeater 90FA when it is installed in the DEChub 90 backplane.</p>
13		<p>Back cover covers the backplane connector and mounting assembly. (Use with standalone units only.)</p>

2

Configuring the DECRepeater 90FA

This chapter contains some of the basic configuration rules and guidelines that must be followed to correctly install the typical DECRepeater 90FA configurations. For more detailed information about installing IEEE 802.3 compliant multisegment LANs, refer to Section 13 of the IEEE 802.3i-1990 standard.

Configuration Rules

The two basic constraints in IEEE 802.3 LAN configurations are segment lengths and the number of repeaters between data terminal equipment (DTE). To ensure the proper operation of the IEEE 802.3 physical layer and access methodology, the network size must meet the round trip propagation delay budget.

Segment Length Constraints

Table 2–1 specifies the maximum segment lengths for the four possible types of media.

Table 2–1 Segment Lengths

	Media Type	Maximum Segment Length (Meters)
Mixing (coaxial)	10Base2 (ThinWire)	185
	10Base5	500
Link	10BaseT (twisted-pair)	100
	FOIRL (fiber)	1000
	10Base-FL (fiber)	2000
AUI	Transceiver cable	50

Network Constraints

The overall network is constrained by the following IEEE 802.3 rules:

1. The transmission path between any two DTEs may consist of up to five segments and four repeater sets (Figure 2-1).

When a network consists of five segments and four repeater sets, a maximum of three of these segments may be mixing (coaxial) segments.

2. The total of all segments (up to five) shall not exceed 2500 meters.

Figure 2-1 shows an example of the maximum number of repeaters on a path using coaxial segments and 10Base-FL segments.

Figure 2-1 DECreepeater 90FA Repeater Path

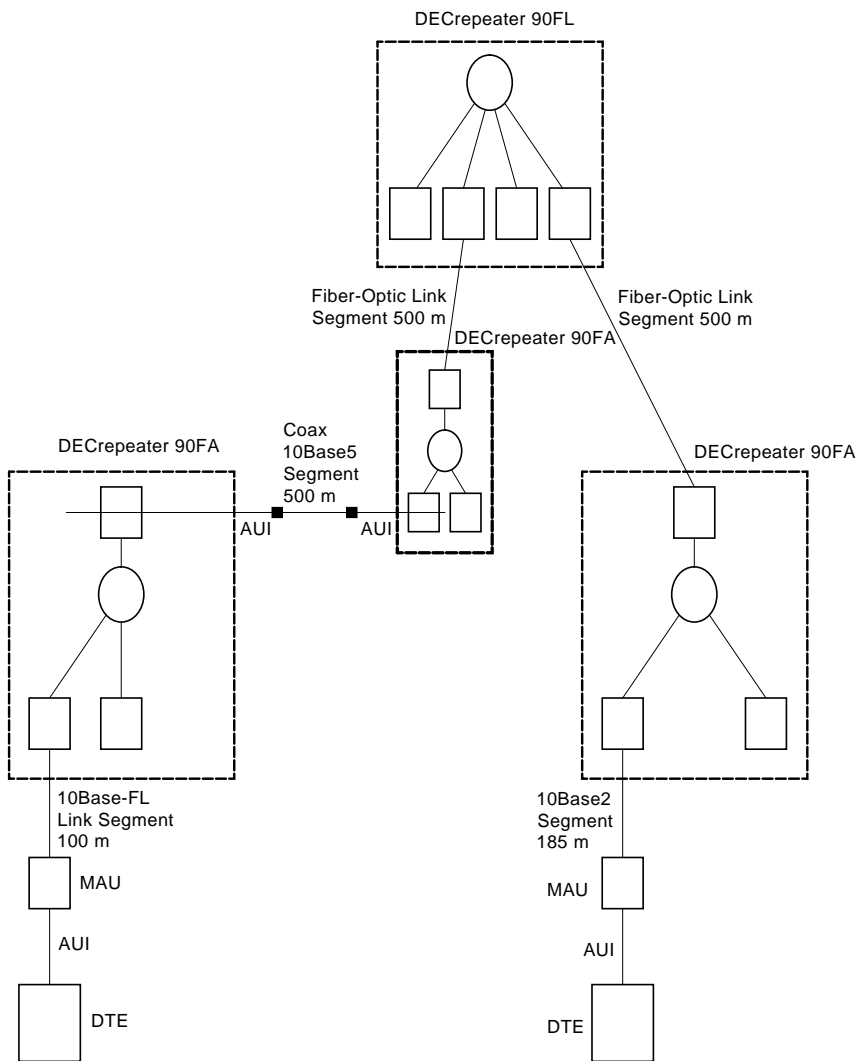

LJ-02372-T10

Figure 2-2 shows a DEChub 90 extended LAN configuration.

Figure 2-2 DECrepeater 90FA Typical DEChub 90 Configuration

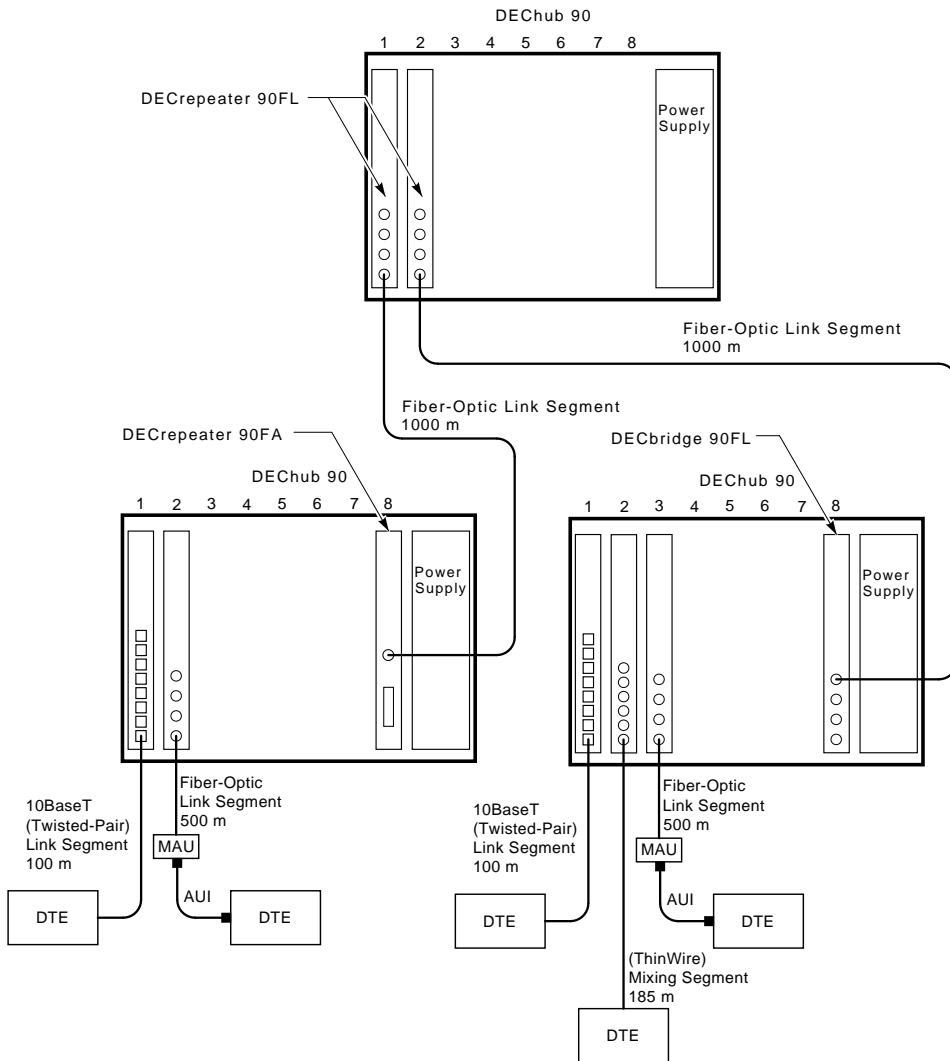

LJ-02373-T10

In this configuration, the requirements of the network extend beyond the five segments and four repeaters allowed by the IEEE 802.3 rules. This configuration is supported by using a bridge to create an extended LAN. The two LANs on either side of the bridge may each contain up to five segments and four repeaters; however, they are able to communicate with one another as if they were on a single LAN.

Installed Fiber Constraints

In addition to following the IEEE 802.3 rules that ensure proper protocol operation, the user must also ensure that the fiber-optic cable plant is properly designed. Although the IEEE 802.3 standard allows for a maximum length of 1000 meters (FOIRL) or 2000 meters (10Base-FL), the fiber-optic segments may be limited by the following characteristics of installed fiber:

- Power budget
- Link-loss
- Wavelength
- Bandwidth

The maximum link distance could be further restricted by the number of splices, interconnects, and cross-connect administration points. Refer to the *DECconnect System Fiber Optic Planning and Configuration* guide for instructions on how to calculate the link certification value for each segment.

3

Installation

Before you install the DECrepeater 90FA repeater, it is recommended that you read this entire manual to become familiar with the features and configuration rules of the DECrepeater 90FA. If problems occur during installation, refer to Chapter 5, Troubleshooting. For additional information that may be useful during installation, refer to Appendix A, Specifications and Parts List.

The DECrepeater 90FA may be installed on a desk top or table, mounted on a wall by its back cover, or installed in a DEChub 90 backplane. The only tool required for installation is a screwdriver. The screwdriver is used to remove the back cover, which covers the backplane connector and mounting assembly, and to mount the repeater or the power supply on the wall.

Site Considerations

The DECrepeater 90FA and its power supply can be placed in various locations, including office areas, computer rooms, or wiring closets, as long as the environmental requirements are met. These requirements are provided in Table A-2, Operating Environment, in Appendix A.

Standalone Installation

To install the DECrepeater 90FA on a desk top or table, make sure that the air circulation around the DECrepeater 90FA does not become obstructed by papers or other materials. Refer to the environmental specifications provided in Table A-2 in Appendix A.

Mount the DECrepeater 90FA on a Wall

To install the DECrepeater 90FA as a standalone wall-mount unit, perform the following procedure:

1. Remove the cover (if necessary).
 - a. Insert a small screwdriver into the top mounting hole on the cover (Figure 3-1).
 - b. Lift the internal latch with the screwdriver, then pull the cover away and down from the top of the unit.

Figure 3-1 Removing the Back Cover

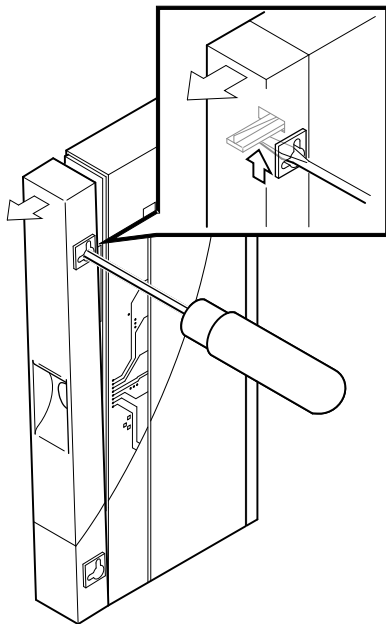

LJ-00320-T10

2. Use the mounting holes on the back cover to determine the placement for the mounting screws on the wall (Figure 3–2).
3. Secure the back cover to the wall using the mounting screws.

Figure 3–2 Mounting Screws

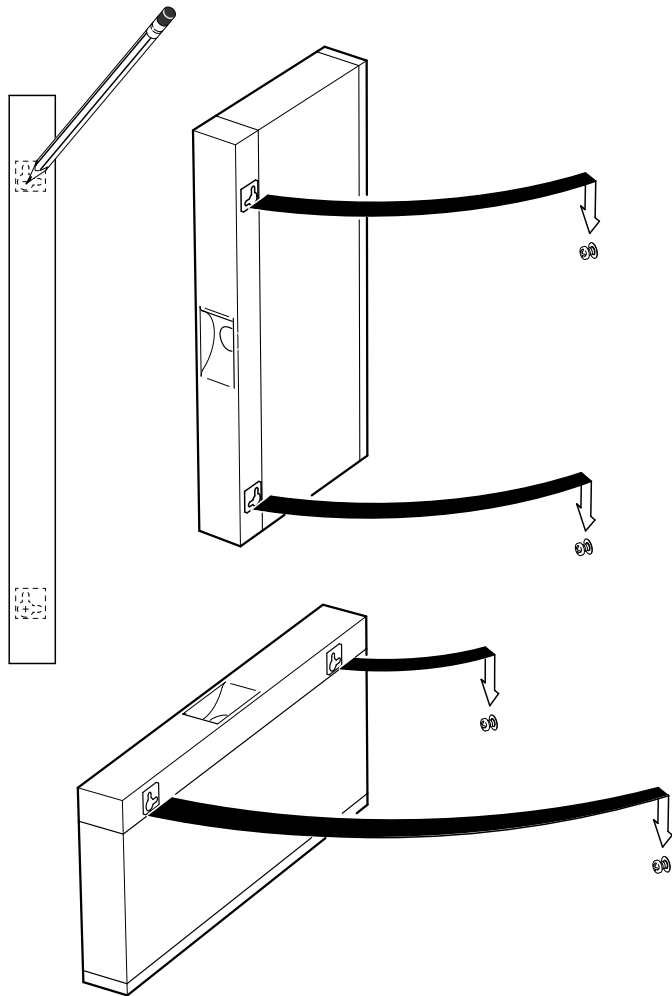

LJ-00701-T10

The screws should be tight enough to provide resistance if you try to remove the back cover from the wall. However, do not make the screws so tight that the cover is distorted or cannot be removed from the wall.

4. Remove the back cover from the wall.
5. Attach the back cover to the repeater.
6. Mount the repeater onto the mounting screws.

Standalone Installation Connections

To make the DECrepeater 90FA standalone installation connections, perform the following procedure and refer to Figure 3–3:

1. Connect the cable from the power supply to the 7-pin power connector on the DECrepeater 90FA. Align the power symbol on the dc power connector with the power symbol on the DECrepeater 90FA and push straight in.
2. Connect the DECrepeater 90FA to the power source.

For **120/240 V** power outlets, connect the power supply cord to the modular power supply, then to the wall outlet.

3. If desired, connect the Ethernet ThinWire segment to a T-connector; connect the T-connector to the port 0 BNC network connector. Terminate the T-connector using a 50-ohm terminator or extend the Ethernet segment to the next device.

The port 0 status activity LED should be on or flashing to indicate the amount of traffic on the network. The LED intensity varies with the amount of traffic: the more traffic, the brighter the LED will appear.

4. Connect the AUI cable to port 2, if required by the application.
5. Connect the fiber-optic cables to port 1 using 2.5-millimeter ST type bayonet connectors, if required by the application.

The DECrepeater 90FA is now installed.

Figure 3-3 Standalone Installation

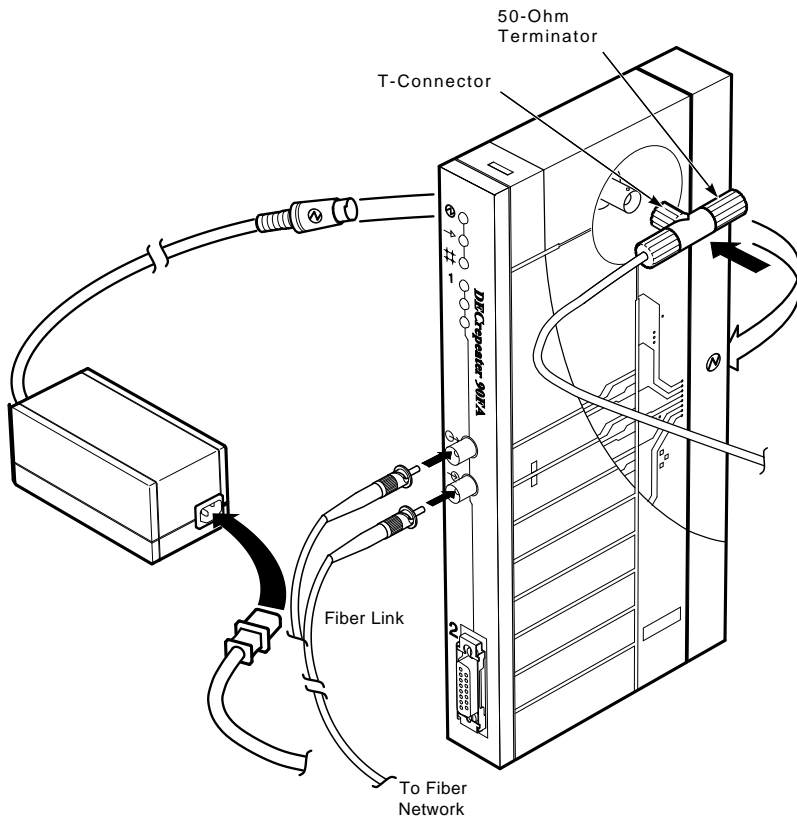

LJ-02374-T10A

Backplane Installation

To install the DECrepeater 90FA in the DEChub 90 backplane, perform the following procedure:

1. Remove the back cover (if necessary).
 - a. Insert a small screwdriver into the top mounting hole located on the cover.
 - b. Lift the internal latch with the screwdriver and pull the cover away and down from the top of the unit (Figure 3–1).
2. Install the DECrepeater 90FA into slot 7 or 8 of the backplane.

Place the lower mounting tab, located on the back of the repeater, into slot 7 or 8 of the backplane (Figure 3–4).
3. Rock the repeater into place. You will hear a click when the repeater is secured in the slot.
4. Supply power to the backplane if this is a new installation.
5. Connect the AUI cable to port 2, if required by the application.
6. Attach the fiber-optic cables to port 1, if required by the application.

The DECrepeater 90FA is now installed.

Note

The DECrepeater 90FA can be installed into or removed from the DEChub 90 backplane while power is supplied to the backplane (hot swap).

Figure 3-4 Installing the DECRepeater 90FA into the DEHub 90

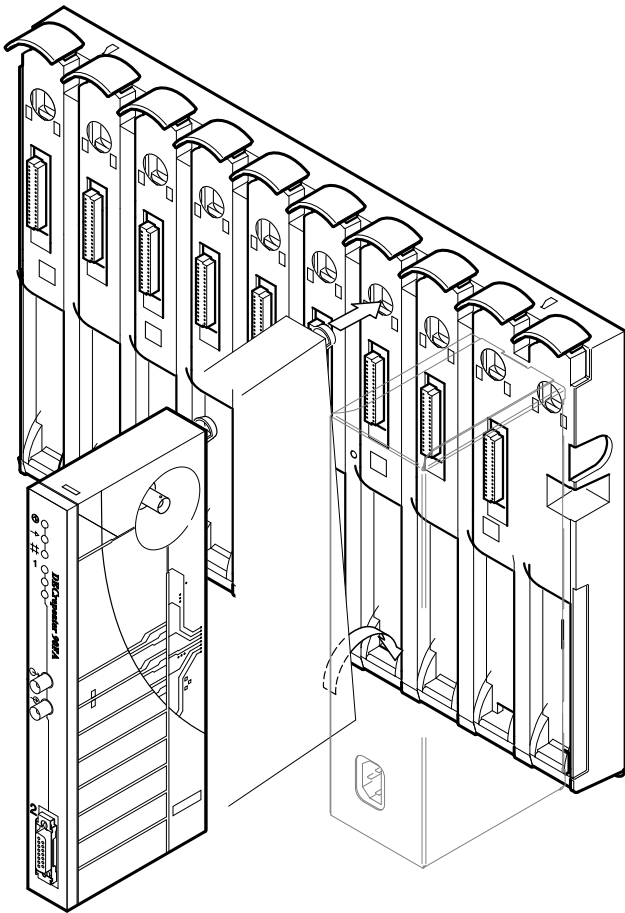

LJ-02375-T10

4

Managing the DECRepeater 90FA

This chapter provides information about managing the DECRepeater 90FA repeater on a network using the Maintenance Operations Protocol (MOP) for VMS or ULTRIX operating systems. This chapter also describes the management functions, commands, techniques, and messages.

The DECRepeater 90FA is managed online using a DECbridge 90 series unit in a DEChub 90 backplane. All commands that affect the DECRepeater 90FA are part of the DECbridge 90 series command set.

Functions

Online management allows the user to perform the following functions:

- Identify all repeaters in the DEChub 90.
- Examine port status (enabled, disabled, properly operating, or inoperative) of repeater ports that share the DEChub 90 backplane with a bridge.
- Examine the work group address database entries 1 to 200, annotated with the repeater port to which each is attached, if any.
- Reset any repeater in the DEChub 90 backplane.
- Enable or disable a repeater port.
- Define the bridge password.

See the Description of Commands section of this chapter for additional information about command syntax.

Components Needed

The following components are needed to manage a DECRepeater 90FA online:

- DEChub 90 backplane
- DECbridge 90 series work group bridge
- DECRepeater 90FA

Accessing MOP from VMS Systems

The MOP console carrier on a VMS operating system is included as part of the Network Control Program (NCP) facility, which requires a DECnet license. You do not need increased user privileges to use the NCP facility; however, to establish a console carrier session, you must know the following:

- The Ethernet address of the bridge used for management
- The Ethernet name of the circuit containing the bridge

The circuit name is needed because a VMS operating system may have more than one Ethernet interface. The Ethernet address is located on the front panel label on a DECbridge 90 series unit.

Table 4–1 lists the Ethernet circuit names, based on system types, that apply.

Table 4–1 Ethernet Circuit Names for Systems

System	Ethernet Circuit Name
VAX 6000 and VAX 9000 XMI computers	mna-0
BI-based systems (VAX 6300 and VAX 6400 computers)	bn-a-0
VAX 4000 computer series	isa-0
MicroVAX systems and VAX 3600 and VAX 3900 computers	qna-0
VAXstation 2000 and VAXstation 3000 computer series	sva-0
VAX–11/780 and VAX–11/785 computers (UNIBUS)	una-0

Example:

If the bridge address is 08-00-2B-01-23-45 and the Ethernet circuit name is sva-0, a typical VMS system command line to establish the session from a VAXstation 3100 computer is:

```
$ MCR NCP CONNECT VIA SVA-0 PHYSICAL ADDRESS 08-00-2B-01-23-45
```

When you establish the connection, the following message appears on the screen:

```
Console connected (press CTRL/D when finished)
```

Accessing a Bridge Repeatedly

If you need to access a specific bridge repeatedly, you can enter the Ethernet address for the bridge in the NCP database by choosing an arbitrary address in area 13. Bridge names in the NCP database may have a maximum of six characters.

Example:

If you name your bridge DBRG1 on address 13.87 and access it from a VAX 6400 computer (the Ethernet circuit name is bna-0), you could use the following commands:

```
$ NCP
NCP> DEFINE NODE DBRG1 ADDRESS 13.87 HARDWARE
08-00-2B-01-23-45
SERVICE CIR BNA-0
NCP> SET NODE DBRG1 ALL
```

To access the bridge, enter the following:

```
$ NCP CONNECT NODE DBRG1
```

Accessing MOP from ULTRIX Systems

On ULTRIX operating systems, the console carrier is a separate utility included as part of the MOP option. This option is part of the regular distribution, however, it is not selected by default and is not included in the basic installation. You can install the MOP option from the original distribution media using the **setld** utility. You must have superuser privileges to invoke console carrier.

Once the MOP option is installed, each bridge to be managed must be given a name and a dummy node number using the **addnode** utility. For example:

```
# addnode 13.1 DBRG1
```

After the name and node number are assigned, you can establish the link at any time using the `ccr` command:

```
# ccr -n DBRG1 -h 08-00-2B-01-23-45 -c sva-0
```

In this example, the `-h` qualifier is followed by the station address of the DECbridge unit to be attached. The `-c` qualifier is followed by the name of the Ethernet circuit to use for the connection. Ethernet circuit names, based on system type, apply. Refer to Table 4–1 for circuit names.

Console Carrier User Interface

The DECbridge 90 is not shipped with a pre-set password; therefore, no password prompt appears on the screen when you connect for the first time. For secure operation of the DECbridge 90, you should define a password using the `DEFINE BRIDGE PASSWORD` command.

The password prompt is represented by the pound sign (`#`). If you do not define a password, then the password prompt does not appear on the screen when you log in.

You have three attempts to enter a password; if all three attempts fail, then you must disconnect and try again.

After you enter the correct password, or if there is no password, the DECbridge console carrier management banner and prompt will appear on the screen as follows:

```
Copyright © Digital Equipment Corporation 1991.
```

```
DEWGB V2.0 08-00-2B-2D-9B-81  
EPROM V2.7 ©1991,92 Digital Equip Corp 25-JUN-92  
DECbridge>
```

Console Carrier Command Language

You can type a question mark (`?`) at any point in the command line to show a list of the options available at that point in the command line. The system accepts unique command abbreviations.

Table 4–2 summarizes the DECbridge commands that apply to the DECrepeater 90FA. For a complete list of commands, refer to the *DECbridge 90 Owner's Manual* or the *DECbridge 90FL Owner's Manual*.

Table 4–2 Summary of DECbridge 90FA Commands

Command	Argument and Parameter
DEFINE ¹	BRIDGE AGE <i>age</i> BRIDGE FLOOD ENABLE DISABLE BRIDGE HUB MANAGEMENT ENABLE DISABLE BRIDGE PASSWORD <i>password string</i> BRIDGE SPANNING TREE ENABLE DISABLE PORT <i>port number</i> ENABLE DISABLE PROTOCOL <i>protocol number</i> FILTER ALL <i>protocol identifier</i> FILTER BACKBONE <i>protocol identifier</i> FILTER GROUP <i>protocol identifier</i> FILTER WORKGROUP <i>protocol identifier</i> FORWARD <i>protocol identifier</i> NONE
DISPLAY	No arguments or parameters are needed
LIST	BRIDGE PROTOCOL <i>protocol number</i>
SET ²	ALL BRIDGE AGE <i>age</i> BRIDGE FLOOD ENABLE DISABLE BRIDGE HUB_MANAGEMENT ENABLE DISABLE

¹Changes made with the DEFINE command change only the default settings, which are assumed on power-up or reset. DEFINE commands do not change the currently active values.

²The SET commands change only the currently active values, but do not affect the defaults that are assumed on power-up or reset.

(continued on next page)

Table 4–2 (Cont.) Summary of DECbridge 90FA Commands

Command	Argument and Parameter
	BRIDGE SPANNING TREE ENABLE DISABLE
	PORT <i>port number</i> ENABLE DISABLE
	PROTOCOL <i>protocol number</i> FILTER ALL <i>protocol identifier</i> FILTER BACKGROUND <i>protocol identifier</i> FILTER GROUP <i>protocol identifier</i> FILTER WORKGROUP <i>protocol identifier</i> FORWARD NONE
	REPEATER
SHOW	ADDRESS [<i>start index</i> , <i>stop index</i>] BRIDGE PORT <i>port number</i> REPEATER <i>hub slot number</i>

Description of Command Parameters

A *start index* or *stop index* for an address is a decimal index into the work group forwarding database in the range of 1 to 200.

A *slot number* is a single number ranging from 1 to 8 that identifies a hub slot containing a DEC repeater 90FA. When two DEChub units are connected together, the *hub number* (1 or 2) is specified before the slot number. For example, the *hub slot number 2,4* refers to the fourth slot from the left in the second DEChub, which is the hub that does not contain the DECbridge 90.

A *password string* is a string of a maximum of 16 characters.

A *port number* is either a DECbridge 90 port, or the number of a port on a repeater that is installed in the DEChub backplane with the bridge. The bridge backbone port is the single digit 1. The work group port is 2. A port is identified by a hub slot number and the port number within the slot.

Description of Commands

This section describes the commands used by the DECrepeater 90FA. The examples used to explain the commands are based on the configuration shown in Figure 4-1, Sample Configuration.

DEFINE BRIDGE HUB_MANAGEMENT DISABLE **SET BRIDGE HUB_MANAGEMENT DISABLE**

Disables all repeater management through the DECbridge 90 unit for DECrepeater 90FA units in the DEChub 90 backplane. When disabled, you receive an error message with the SHOW REPEATER, SET PORT, or SHOW PORT commands on repeater ports. You do not receive port number information from the SHOW ADDRESS command.

DEFINE BRIDGE HUB_MANAGEMENT ENABLE **SET BRIDGE HUB_MANAGEMENT ENABLE**

Reverses the affect of the SET or DEFINE BRIDGE HUB_MANAGEMENT DISABLE commands.

DEFINE BRIDGE PASSWORD *password string*

Lets you change the password string. You are prompted twice for a new password. The password may be a maximum of 16 characters and does not appear on the screen. The system saves the new password. There is no corresponding SET command because the DEFINE BRIDGE PASSWORD takes effect immediately.

The MOP option provides a mechanism for setting and checking passwords. This mechanism is intended to provide protection against accidental tampering with parameters and is not intended as a security feature. No attempt is made to prevent compromise of the password by malicious users. The DECbridge 90 should not be used in applications that depend on the prevention of any unauthorized modifications to the parameters.

LIST BRIDGE

Displays the nonvolatile bridge-wide parameters.

SET PORT [*hub number*,] *slot number*,*port number* **DISABLE**

Disables the attachment of a specific repeater port in the DEChub backplane. The port status indicator on the selected DECrepeater 90 flashes, indicating that the port was disconnected by the network manager. There is no equivalent DEFINE command for disabling repeater ports.

Example 1:

The expected response to a SET PORT DISABLE command for a DECrepeater 90FA appears as follows:

```
DECbridge>SET PORT 1,3,1 DISABLE
Hub 1 slot 3 port 1 segment counter 0 status: disabled-operational
```

SET PORT [*hub number*,] *slot number*, *port number* **ENABLE**

Reverses the effect of SET PORT DISABLE for DECrepeater 90 ports.

Example 2:

The expected response to a SET PORT ENABLE command for a DECrepeater 90FA appears as follows:

```
DECbridge>SET PORT 1,3,1 ENABLE
Hub 1 slot 3 port 1 segment counter 0 status: no carrier loopback
```

SET REPEATER [*hub number*,]*slot number* **RESET**.

Resets a specific repeater. There is no output response to this command. All disabled ports are enabled.

SHOW ADDRESS [*start index*,*stop index*]

Displays the station address in a selected range (1 to 200) of entries in the address database. The start index value always appears; however, other entries in the range appear only if they are not empty. Addresses in this database are all in the work group. If indexes are omitted, the addresses of all stations in the work group are listed.

When the DECbridge 90 unit is used with a DECrepeater 90 series repeater, the hub slot number and repeater port to which each station is attached will also appear on the screen. Note that it may take several minutes for the SHOW ADDRESS command to accurately reflect the correct repeater port number for stations recently added to the network or station that have been moved from one port to another. See Appendix B, Management Details, for further information about the SHOW ADDRESS command.

Example 1:

This command displays all addresses contained within the hub configuration. Address 5 and address 7 show the same hub, slot, and port because both devices are daisy chained on the same port.

```
DECbridge>SHOW ADDRESS
Address 1: 08-00-2B-0F-19-23
Address 2: 08-00-2B-10-20-30 hub 2 slot 8 port 4
Address 5: 08-00-2B-10-6A-31 hub 2 slot 3 port 3
Address 6: 08-00-2B-A6-43-17 hub 1 slot 3 port 5
Address 7: 08-00-2B-16-23-4C hub 2 slot 3 port 3
```

Example 2:

The expected response to a SHOW ADDRESS command to a nonexisting address appears as follows:

```
DECbridge>SHOW ADDRESS 3
Address 3: unused
```

Example 3:

The expected response of a SHOW ADDRESS command to a valid address appears as follows:

```
DECbridge>SHOW ADDRESS 2
Address 2: 08-00-2B-10-20-30 hub 2 slot 8 port 4
```

Example 4:

The expected response of a `SHOW ADDRESS` command for a range of addresses appears as follows:

```
DECbridge>SHOW ADDRESS 2,6
Address 2: 08-00-2B-10-20-30 hub 2 slot 8 port 4
Address 5: 08-00-2B-10-6A-31 hub 2 slot 3 port 3
Address 6: 08-00-2B-A6-43-17 hub 1 slot 3 port 5
```

SHOW PORT [*hub number,*] *slot number, port number*

Shows whether the port is enabled or disabled and shows the operational status of the port. Hub numbers can be 1 or 2; slot numbers can be 1 to 8. For the DECrepeater 90T, port numbers are 1 to 8; for the DECrepeater 90C, port numbers are 1 to 6; for the DECrepeater 90FL, port numbers are 1 to 4; for the DECrepeater 90A, port numbers are 1 to 3.

Example 1:

The expected response to a `SHOW PORT` command appears as follows:

```
DECbridge>SHOW PORT 3,2
Hub 1 slot 3 port 2 segment counter 0 status: disabled-no carrier loopback
```

The hub was not defined in the command; therefore, the default (1) was used.

Example 2:

A `SHOW PORT` command for hub 2 appears as follows:

```
DECbridge>SHOW PORT 2,3,2
Hub 2 slot 3 port 2 segment counter 0 status: operational
```

SHOW REPEATER [[*hub slot number,*]*slot number*]

Shows the type of repeater and the port status for each port on that repeater. The hub number can be 1 or 2, and slot numbers can be 1 to 8. If you do not include parameters, information is shown for all repeaters in both hubs.

Example 1:

The expected response to a SHOW REPEATER command appears as follows:

```
DECbridge>SHOW REPEATER
Hub 1 slot 3 twisted pair, repeater, rev.1, 8 ports.
Hub 1 slot 4 ThinWire repeater, rev.1, 6 ports.
Hub 2 slot 3 ThinWire repeater, rev.1, 6 ports.
Hub 2 slot 6 twisted pair repeater, rev.1, 8 ports.
Hub 2 slot 8 twisted pair repeater, rev.1, 8 ports.
```

Note that both the DEC repeater 90T and DEC repeater 90C repeaters are installed in the hub.

Example 2:

The response to a SHOW REPEATER command to a slot that contains a device other than a repeater appears as follows:

```
DECbridge>SHOW REPEATER 1
No repeater responds.
```

Example 3:

The response to a SHOW REPEATER command to an empty slot appears as follows:

```
DECbridge>SHOW REPEATER 7
No repeater responds.
```

Example 4:

The response to a SHOW REPEATER command for a particular repeater appears as follows:

```
DECbridge>SHOW REPEATER 3
Hub 1 slot 3 twisted pair, rev.1, 8 ports.
Hub 1 slot 3 port 0 segment counter 0 status: operational
Hub 1 slot 3 port 1 segment counter 1 status: no carrier loopback
Hub 1 slot 3 port 2 segment counter 0 status: disabled
Hub 1 slot 3 port 3 segment counter 0 status: operational
Hub 1 slot 3 port 4 segment counter 1 status: no carrier loopback
Hub 1 slot 3 port 5 segment counter 1 status: no carrier loopback
Hub 1 slot 3 port 6 segment counter 1 status: no carrier loopback
Hub 1 slot 3 port 7 segment counter 1 status: no carrier loopback
Hub 1 slot 3 port 8 segment counter 1 status: no carrier loopback
```

Example 5:

The response to a SHOW REPEATER command for hub 2, slot 3 appears as follows:

```
DECbridge>SHOW REPEATER 2,3
Hub 2 slot 3 ThinWire, rev.1, 6 ports.
Hub 2 slot 3 port 0 segment counter 0 status: operational
Hub 2 slot 3 port 1 segment counter 1 status: no carrier loopback
Hub 2 slot 3 port 2 segment counter 1 status: no carrier loopback
Hub 2 slot 3 port 3 segment counter 1 status: no carrier loopback
Hub 2 slot 3 port 4 segment counter 1 status: no carrier loopback
Hub 2 slot 3 port 5 segment counter 0 status: operational
Hub 2 slot 3 port 6 segment counter 1 status: no carrier loopback
```

Example 6:

The response to a SHOW REPEATER command for hub 2, slot 7 appears as follows:

```
DECbridge>SHOW REPEATER 2,7
Hub 2 slot 7 AUI, rev.1, 1 port.
Hub 2 slot 7 port 0 segment counter 0 status: operational
Hub 2 slot 7 port 1 segment counter 1 status: no carrier loopback
```

Example 7:

The response to a SHOW REPEATER command for hub 2, slot 7 appears as follows:

```
DECbridge>SHOW REPEATER 2,7
Hub 2 slot 7 Fiber, rev.1, 4 port.
Hub 2 slot 7 port 0 segment counter 0 status: operational
Hub 2 slot 7 port 1 segment counter 1 status: operational
Hub 2 slot 7 port 2 segment counter 2 status: operational
Hub 2 slot 7 port 3 segment counter 3 status: operational
Hub 2 slot 7 port 4 segment counter 4 status: operational
```

Example 8:

The response to a SHOW REPEATER command when the DECbridge 90 is not the hub manager or the DECbridge 90 is still in the power-up stage appears as follows:

```
DECbridge>SHOW REPEATER
The DECbridge 90 is not the designated hub manager.
```

There is a 60-second delay after power-up before the DECbridge takes control of the hub.

Figure 4-1 Sample Configuration

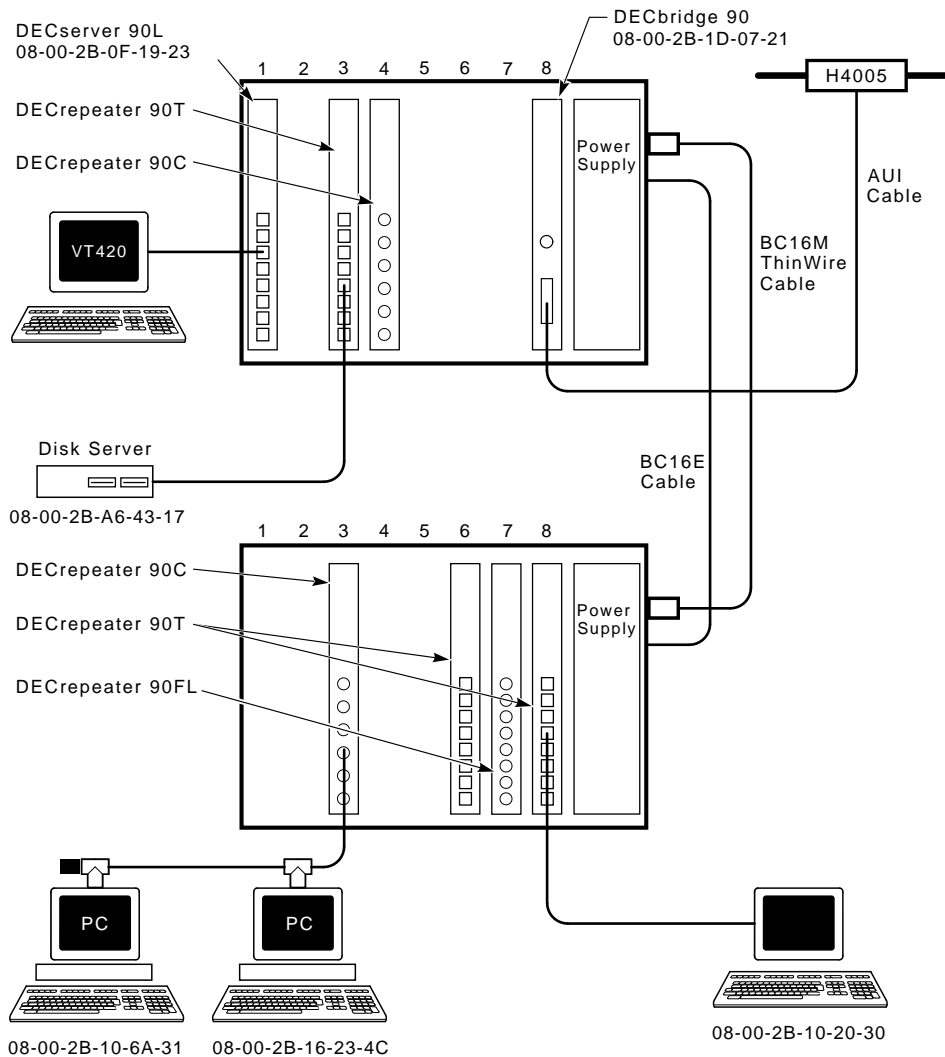

LJ-02153-T10

Typical Management Techniques

The DECrepeater 90FA can be managed as a standalone unit using LEDs, or online within a group of repeaters installed in a DEChub 90. The DECrepeater 90FA comes with LEDs that indicate system status in a standalone

configuration. In a DEChub 90 environment, the repeater may be managed using LEDs as well as online management.

Remote Network Management with the DECbridge 90

You can manage a DECrepeater 90FA with a DECbridge 90 work group bridge and a DEChub 90 backplane. The DECbridge 90 unit communicates across the DEChub 90 backplane to any repeaters in the DEChub. You can also connect two DEChub 90 backplanes together and manage the repeaters in both DEChub 90 backplanes using one DECbridge 90 unit.

The DECbridge unit communicates with the DECrepeater 90FA units using unique signals on the DEChub backplane. The two DEChub 90 backplanes are connected with two cables:

1. ThinWire coaxial cable to carry the work group Ethernet signals
2. DECconnect office cable to carry the management signals

Note

If two DEChub backplanes are being managed by one bridge, the backplanes must be connected BNC to BNC using ThinWire cable (part number BC16M-xx where xx stands for length) and a DECconnect office cable (part number BC16E-xx).

Management Disconnect

A port can be partitioned at any time by the management protocol. The management protocol can be used only for the repeater ports mounted in the DEChub 90 backplane and connected to a DECbridge 90. When a port is disconnected by the management protocol, it can be reconnected either by turning the power off and then on again, or by using the management protocol. If the port LED flashes approximately twice a second, the port is partitioned by the management protocol.

Whether your configuration is a standalone or a DEChub 90 installation, you should create a network topology map to help facilitate management tasks.

Figure 4–2 shows a typical network topology map.

Figure 4–2 Typical Network Topology Map

DEChub 90					
Slot 1	DECrepeater 90T	Slot 2	DECrepeater 90C	Slot 7	DECrepeater 90FA
Port 1	Node - Address - Username	Port 1	Node - Address - Username	Port 1	Node - Address - Username
Port 2	Node - Address - Username	Port 2	Node - Address - Username	Port 2	Node - Address - Username
Port 3	Node - Address - Username	Port 3	Node - Address - Username		
Port 4	Node - Address - Username	Port 4	Node - Address - Username		
Port 5	Node - Address - Username	Port 5	Node - Address - Username		
Port 6	Node - Address - Username	Port 6	Node - Address - Username		
Port 7	Node - Address - Username				
Port 8	Node - Address - Username				

LJ-02377-T10

Management Session

To perform online management commands, establish a MOP console carrier session with the bridge from any remote node. After you connect to the bridge, the following prompt appears on the screen:

```
DECbridge>
```

When a bridge goes through a power cycle or is reset, the bridge begins to poll repeaters for status. This process includes a special algorithm to determine which repeater ports have stations that are attached. The time to complete this algorithm depends on the number of repeaters and the network activity. You should allow time before proceeding to manage the hub. For the same reason, it can take time for the system to report on stations or repeaters that are moved in the hub. See Appendix B, Management Details, for more information.

Example of a Typical Management Session

The following steps show how you can use the SHOW REPEATER and SHOW ADDRESS commands in a typical management session.

1. Determine what repeaters are in the hub.

```
DECbridge>SHOW REPEATER
Hub 1 slot 5 ThinWire repeater, rev.0, 8 ports.
```

In this example, there is a ThinWire repeater (DECrepeater 90C) in the same hub (hub 1) as the bridge (if this is a 2-hub configuration). The repeater is in slot 5 with 6 ThinWire ports.

2. Determine what stations are connected to the repeaters in the hub.

```
DECbridge>SHOW ADDRESS
Address 1: 08-00-2B-19-94-FB
Address 2: 08-00-2B-1E-2D-0C hub 1 slot 5 port 3
```

This indicates that a station with address 08-00-2B-1E-2D-0C is connected to the repeater in slot 5 on port 3. At this point, without physical examination, you have enough information to construct a network map.

3. Determine the status of all ports on the repeater.

```
DECbridge>SHOW REPEATER 5
Hub 1 slot 5 twisted pair, rev.1, 6 ports.
Hub 1 slot 5 port 0 segment counter 0 status: operational
Hub 1 slot 5 port 1 segment counter 0 status: excessive collisions
Hub 1 slot 5 port 2 segment counter 0 status: excessive length collision
Hub 1 slot 5 port 3 segment counter 0 status: operational
Hub 1 slot 5 port 4 segment counter 0 status: excessive length collision
Hub 1 slot 5 port 5 segment counter 0 status: excessive length collision
Hub 1 slot 5 port 6 segment counter 0 status: excessive length collision
Hub 1 slot 5 port 7 segment counter 0 status: excessive length collision
Hub 1 slot 5 port 8 segment counter 0 status: excessive length collision
```

Continue to use the SHOW REPEATER command for each port on the repeater.

If Problems are Reported

The following table describes the status messages and the most common causes.

Message	Most Common Cause
Operational	Cable connected, everything OK.
Excessive length collision	Cable fault, usually either a port that is not connected to anything or an open cable. In the case of 10BaseT, the remote station may be powered down (no link beat).
Excessive collisions	Cable fault, usually either a port that is not connected to anything or an open cable. In the case of 10BaseT, the remote station may be powered down (no link beat).
No carrier loopback	Cable fault, usually a shorted cable.
Transmit carrier drop out	Cable fault, usually a shorted cable.
Jabber	Stations connected to this port continue to transmit; expect a faulty station.

The operational condition is normal. All other conditions cause the repeater to automatically partition the port. When the condition clears, the repeater automatically reconnects the port and reports it as operational unless it is partitioned by management.

To help solve intermittent problems, the repeater reports a segmentation count. This count runs from 0 to 15 and then latches at 15. Every time you enter the SHOW REPEATER command, this count is set to zero.

If this count is not zero, you can tell that a port has partitioned since the last SHOW REPEATER command. This partitioning occurs normally if users turn stations on and off, or if cables are connected and disconnected from the repeater during installation and reconfiguration. If none of these normal causes have occurred, there may be an intermittent problem with cabling or attached stations.

To Disable a Port

The following commands allows the manager to disable a particular port on a repeater. This may be useful if stations attached to that port are causing network difficulties.

```
DECbridge>SET PORT 5,1 DISABLE
Hub 1 slot 5 port 1 segment counter 0 status: disabled-no carrier
loopback
```

To Reset the Repeater

The following command resets the repeater to power-up condition. This includes restoring any ports that have been partitioned by the manager as well as resetting the segmentation counters.

```
DECbridge>SET REPEATER 5 RESET
```

Error Messages

Table 4–3 lists the DECbridge 90 error messages and a description of each message. For a complete list of messages, refer to either the *DECbridge 90 Owner's Manual* or the *DECbridge 90FL Owner's Manual*.

Table 4–3 DECbridge 90 Messages

Error Message	Description
Address <i>n</i> : unused	Address number <i>n</i> does not contain a station address.
Confirmation error - password not changed	The second entry or verification of the new password provided to the DEFINE BRIDGE PASSWORD command did not match the first entry.
DECbridge 90 is not the designated hub manager	The DECbridge 90 was not the designated hub manager when either the SHOW PORT or SHOW REPEATER command was issued. This occurs when <ul style="list-style-type: none">• The bridge is reset and, for 60 seconds, the DECbridge is not the hub manager.• Another DECbridge unit is acting as the current hub manager.• A fault exists in the BC16E cable or in the connections between two DEChub backplanes.• A fault exists in the power supply of one of the DEChub units. This prevents repeater management communication.
Hub management disabled	A SHOW PORT or SHOW REPEATER command was issued to a DECbridge 90 for which repeater management is disabled. Enable repeater management with the SET BRIDGE HUB_MANAGEMENT ENABLE command before trying again.
Hub number and slot number [[hub], slot]. Hub is 1 or 2, slot is 1-15	One or more parameters provided to the SHOW REPEATER command were out of range. The hub number must be either 1 or 2. The slot number must be between 1 and 15.
Hub <i>h</i> slot <i>s</i> - port number out of range	The port number provided to the SHOW PORT command was out of range for the device in hub <i>h</i> slot <i>s</i> . Use the SHOW REPEATER command to determine the number of ports for the device and to specify a port number within that range.

(continued on next page)

Table 4-3 (Cont.) DECbridge 90 Messages

Error Message	Description
Hub <i>h</i> slot <i>s</i> not a repeater	The device does not use the same management protocol as the DEC repeater 90 series repeaters. The device ports, if any, cannot be managed by the DECbridge 90 unit.
Hub <i>h</i> slot <i>s</i> unrecognized type	The repeater type in hub <i>h</i> slot <i>s</i> is not known to the DECbridge 90. The repeater ports can still be managed with the DECbridge 90.
No repeater responds	There is no repeater installed in the requested hub slots, or the repeater is not functioning.
No such port	The bridge port number provided to the SHOW PORT command was invalid. Valid numbers are 1 and 2.
Password too long - not changed	A password longer than 16 characters was given to the DEFINE BRIDGE PASSWORD command.
Port number [[hub,]slot,]port	One of the parameters provided to a SET PORT or DEFINE PORT command was not a valid hub, slot, or port number.
Station address number [first [,last]] in range 1-200	One or more parameters provided to the SHOW ADDRESS command was invalid. The valid range is 1 to 200.
Unsupported by this hardware revision	This occurs when you attempt to execute a SET or DEFINE BRIDGE FLOOD command on a bridge with a firmware revision of 1 (DECbridge 90 V1.4) but have loaded V2.5 or a later version flash EPROM. The old hardware revision does not support flood mode. These version numbers appear in the MOP console connection banner.
???	A command or parameter was not recognized. Enter ? to display valid commands.
180501	A loopback diagnostic has run and passed on the backbone port. If the backbone port is not receiving any messages, this diagnostic is run every 10 minutes.
180201	A loopback diagnostic has run and passed on the work group port. If the work group port is not receiving any messages, this diagnostic is run every 10 minutes.
1805:00-00-00-00-01	A loopback diagnostic has run and failed on the backbone port. The diagnostic is tried every 5 seconds until the test passes.

(continued on next page)

Table 4–3 (Cont.) DECbridge 90 Messages

Error Message	Description
1802:00-00-00-00 01	A loopback diagnostic has run and failed on the work group port. The diagnostic is tried every 5 seconds until the test passes.

Standalone Configuration Management

The recommended process for managing a small standalone network is as follows:

- Maintain records indicating which stations are connected to each port on each repeater. It may be desirable to draw a network topology map (Figure 4–2).
- Observe the LEDs on the repeater for network status. Refer to Chapter 1, Table 1–1, for a description of each LED and its function.

Note

After you power up a standalone DECrepeater 90FA, all LEDs, except the network activity LED, stay on if there are no active connections, or if there is no hardware or network activity. After an active station is connected to one of the ports, the LED for the active port stays on and all other ports turn off.

5

Troubleshooting

This chapter provides troubleshooting information for the DEC repeater 90FA repeater when used as a standalone unit or when installed in the DEChub 90 backplane.

Before you start to troubleshoot a problem:

1. Verify the installation of the repeater. The installation must meet the configuration rules provided in Chapter 2, Configuring the DEC repeater 90FA.
2. Note the fault condition.
3. Isolate the problem.

Port Partitioning

Any messages or data packets received from any port by the DEC repeater 90FA are transmitted to all ports. The port status LEDs display the following port partition status:

On	The port is not partitioned.
Off	The port is autopartitioned.
Flashing	The port is partitioned by management.

Each port is automatically controlled by the repeater function and can be partitioned for any of the reasons shown in Table 5-1 and Table 5-2.

Table 5–1 DECreepeater 90FA Status Indicators

LED	Fault	Non-Fault
Ports 0 through 2 flashing	–	Partitioned by management.
Port 0 off	Open cables Shorted cables Cables not properly connected	Port not connected.
Port 1 off	Link problem (see Table 5–2)	Link not connected.
Port 2 off	AUI cable not connected to MAU MAU not functioning Coaxial cable not terminated	Port not connected.

Table 5–2 DECreepeater 90FA Fiber-Link Indicators

LED	Fault	Correction
Port 1 off	Cables not connected	Connect fiber cables.
	Transmit/receive not connected	Cross over the cables (transmit to remote receive; receive to remote transmit).
	Lack of idle signal	Power up the remote repeater/DTE.
	Low light	Reduce attenuation of the fiber segment. Consider cable type, link loss, and connector loss variables.

DECRepeater 90FA Standalone Troubleshooting

To troubleshoot a DECRepeater 90FA standalone installation, refer to Table 5–3 for a list of possible error conditions and the corrective action.

Table 5–3 Troubleshooting a DECRepeater 90FA Standalone Unit

If...	Then...	Do this...
All LEDs are off.	Check the ac power connection.	Check that the power supply is properly plugged into the power outlet. Check the power to the power outlet.
	Check the power supply.	Check the 7-pin connector at the repeater unit. If the connections are okay, replace either the power supply or both the power supply and power cord.
The network activity LED is off.	There is low network activity or no network activity.	Ensure that network activity is present.
	If the network activity LED still fails to light	Turn the repeater off and on by unplugging and replugging the power supply. Check that the network activity LED comes on momentarily.
	If the network activity LED lights momentarily, the LED portion of testing has passed. If the network LED fails to light	Replace the repeater.
The port 0 status LED is off.	If port 0 is connected, the port may be segmented or the LED may have failed.	Remove all network connections to the repeater. Power the repeater off and on by unplugging and replugging the power supply. All port status LEDs should come on and, in the absence of network activity, remain on.

(continued on next page)

Table 5–3 (Cont.) Troubleshooting a DECRepeater 90FA Standalone Unit

If...	Then...	Do this...
	If the port 0 status LED does not light and/or remain on	Replace the repeater.
	If the port 0 status LED does remain on, the port may be segmented when connected to the network.	Terminate port 0 with a T-connector and two 50-ohm terminators. Reconnect a front panel fiber segment carrying network activity. The repeater activity LED will light.
	If port 0 status LED does not remain on	Replace the repeater.
	If the port 0 status LED does remain on	Remove the T-connector and the terminators, and reconnect the ThinWire segment.
	If the port 0 status LED turns off, either the ThinWire cable is open, shorted, not terminated properly, or the external equipment is transmitting incorrect data.	Ensure the operation of external equipment and cable, or replace the it with a known good segment carrying valid traffic.
A fiber-link LED is off.	Ensure the cable to the receive channel of the port in question is good, and that the external equipment is transmitting the idle signal.	Reconnect the same cables and external device to another repeater port.
Port 1 status LED is off.	If the fiber-link LED for the new port comes on, the fiber-link LED of the original port is faulty. The fiber port may be segmented, or the LED may have failed.	Replace the repeater. Ensure that network activity is present (a segmented port will require data to return to normal status). The repeater activity LED should be on.

(continued on next page)

Table 5–3 (Cont.) Troubleshooting a DECRepeater 90FA Standalone Unit

If...	Then...	Do this...
<p>No traffic is received from or by an external device connected to a fiber port with both fiber-link and port status LEDs on.</p>	<p>If the fiber-link LED is on</p>	<p>Remove all network connections from the repeater. Turn the repeater off and on. Check that all the port status LEDs come on. There will be no activity; therefore, the port status LEDs should remain on.</p>
	<p>If all port status LEDs do not remain on</p>	<p>Replace the repeater.</p>
	<p>If all port status LEDs do remain on, the port in question may be segmenting in use. This occurs if the port in question does not receive the idle signal from the external device, or the external device is transmitting improperly.</p>	<p>Reconnect the port in question. The fiber-link LED should come on and the status LED should remain on.</p>
	<p>If the fiber-link LED does not come on</p>	<p>Refer to the fiber-link troubleshooting section of this table.</p>
	<p>If the fiber-link LED does come on but the port status LED turns off</p>	<p>Confirm the operation of the external device. Connect the same device to another fiber port.</p>
	<p>If the fiber-link and status LEDs of the second port are both on, the fault is internal to the transmitter of the original port.</p>	<p>Replace the repeater.</p>
	<p>It is possible that the external device is not receiving the idle signal from the repeater.</p>	<p>Use a single cable to loop the transmit channel of the port in question to the receive channel of another repeater port.</p>

(continued on next page)

Table 5–3 (Cont.) Troubleshooting a DECRepeater 90FA Standalone Unit

If...	Then...	Do this...
The port 2 status LED is off.	If the fiber-link LED of the receiving port lights, the idle signal is present.	Check the cable to the external device, and check the external device for correct operation.
	If the fiber-link LED of the receiving port does not come on	Replace the cable with a known good cable.
	If the fiber-link LED of the receiving port still fails to come on	Replace the repeater.
	Port 2 is either segmented or the LED has failed.	Check to see if port 2 status LED is defective. Remove all front panel connections and the port 0 connection. Power the repeater off and on. Ensure that the port 2 status LED lights and remains on.
	If port 2 status LED does not light and remain on	Replace the repeater.
	If port 2 status LED lights and remains on	Restore all port connections on the repeater.
	Check port 0 and port 1 status LEDs. If both port status LEDs are off	Check to see that port 0 or 1 are properly connected to active network segments. Using previous troubleshooting steps, ensure that either port 0 or port 1 is functioning before troubleshooting port 2.
If either port 0 or port 1 status LEDs are on, and port 2 status LED goes off, it is likely that port 2 is segmented. Correction of the segmentation fault should correct the problem.	Check the AUI connection. Ensure that the cable is properly connected and the slide latches are secured.	

(continued on next page)

Table 5–3 (Cont.) Troubleshooting a DECRepeater 90FA Standalone Unit

If...	Then...	Do this...
	If the AUI connection is secure	Check that the MAU is being powered by the repeater. (Most MAUs have a Power OK LED.)
	If the MAU is not powered by the repeater	Replace the repeater.
	If the MAU is powered by the repeater, the fault is probably due to an improper MAU connection to the medium.	Ensure that the medium is correctly attached and that it is properly terminated. Correction of the medium attachment should resolve the problem.

DECrepeater 90FA Backplane Troubleshooting

To troubleshoot a DECrepeater 90FA installed in a DEChub 90 configuration, refer to Table 5–4 for a list of possible error conditions and the corrective action.

Table 5–4 Troubleshooting a DECrepeater 90FA in a DEChub 90 Backplane

If...	Then...	Do this...
The power LED is off.	The repeater does not have correct operating voltage.	Check the power LED on the DEChub 90 power supply.
	If the power LED on the DEChub 90 is off, there is a problem with the DEChub 90 power supply.	See the troubleshooting procedures in the <i>DEChub 90 Owner's Manual</i> .
	If the power LED on the DEChub 90 power supply is on, check the power LEDs on other modules. If all power LEDs are off, the DEChub 90 has a power distribution problem.	See the troubleshooting procedures in the <i>DEChub 90 Owner's Manual</i> .
	If there is power to other modules, ensure that the repeater is correctly seated in either slot 7 or 8 of the DEChub 90. (Slots 7 and 8 are the only ones that provide the +12.0 V necessary to operate the DECrepeater 90FA.)	Reseat module in slot 7 or 8.
	If the power LED turns on when reseated in the same slot, the repeater was not properly installed. Problem should be corrected.	Return to normal operation.
	If the power LED turns on when reseated in another slot, but not when installed in the original slot, there is a power distribution problem to that slot within the DEChub 90.	See the troubleshooting procedures in the <i>DEChub 90 Owner's Manual</i> .

(continued on next page)

Table 5–4 (Cont.) Troubleshooting a DECreepeater 90FA in a DEChub 90 Backplane

If...	Then...	Do this...
The network activity LED is off.	If the repeater does not turn on in either slot 7 or 8, check those slots with another known good module. If the known good module powers up, and the repeater does not, the repeater is defective.	Replace the repeater.
The port 0 status LED is off.	The repeater or any other unit in the DEChub 90 may not be connected to an active segment.	Connect a known active segment to any unit in the DEChub 90. Look for an indication of network activity on any unit in the DEChub 90.
The port 0 status LED is off.	If the repeater is connected to a known active segment and the network activity LED is off, the repeater is defective.	Replace the repeater. (See the following port 0 status section.)
The port 0 status LED is off.	Port 0 may be segmented or the LED may be defective.	Remove all front panel fiber port connections. Power the repeater off and on by reseating the unit in the DEChub 90. Ensure that the port 0 status LED lights and remains on.
The port 0 status LED is off.	If the port 0 status LED does not light and remain on	Plug the repeater into another slot in the DEChub 90. If possible, choose a known good slot.
The port 0 status LED is off.	If the port 0 status LED does not light and remain on	Replace the repeater.
The port 0 status LED is off.	If the port 0 status LED does light and remain on, there is a problem with the DEChub 90.	See the troubleshooting procedures in the DEChub 90 Owner's Manual.

(continued on next page)

Table 5–4 (Cont.) Troubleshooting a DECreepeater 90FA in a DEChub 90 Backplane

If...	Then...	Do this...
	<p>If any other units in the DEChub 90 indicate network activity, the repeater activity LED should be on. If the port 0 status LED is on and the activity LED is off, port 0 is not receiving traffic.</p>	Replace the repeater.
	<p>If the port 0 status LED is on, and the activity LED is on, the front panel fiber ports should be reconnected.</p>	Reconnect the front panel fiber ports.
Port fiber-link LED is off.	<p>Ensure the cable to the receive channel of the port in question is good, and that the external equipment is transmitting the idle signal.</p>	Reconnect the same cables and external device to another repeater port.
	<p>If the fiber-link LED for the new port comes on, the original port fiber-link LED has failed.</p>	Replace the repeater.
Port 1 status LED is off.	<p>The fiber port may be segmented or the LED may have malfunctioned.</p>	<p>Disconnect all front panel fiber connections to the repeater. Power the unit off and on by removing and reseating it in the DEChub 90.</p>
	<p>All port status LEDs should light momentarily. (If there is no activity on the DEChub 90, they will light and stay on.) If any port status LED does not light momentarily</p>	Replace the repeater.

(continued on next page)

Table 5–4 (Cont.) Troubleshooting a DECRepeater 90FA in a DEChub 90 Backplane

If...	Then...	Do this...
	If all port status LEDs do light momentarily, the ports should be reconnected one at a time.	Reconnect each fiber port receive channel. Note that the external device will not be receiving the idle signal and should not be transmitting data; therefore, the port fiber-link and status LEDs should light as each receive channel is connected.
	If the fiber-link LED lights and the port status LED does not come on	Reconnect the receive channel of a different port on the repeater.
	If the fiber-link LED lights and the port status LED fails to light	Ensure that the external equipment is operating properly. Connect the transmit channel of a known good device to the receive channel of the ports in question.
	If the fiber-link LED lights and the port status LED remains off	Check that the repeater network activity LED is on. An unconnected port will be segmented and will require good data to be transmitted before it is unsegmented. Connecting the receive channel of a port should establish the link; however, a good packet of data must be available for transmission to unsegment and return the port to normal status.
	If the fiber-link LED lights and the port status LED remains off while the repeater activity LED is on	Replace the repeater.

(continued on next page)

Table 5–4 (Cont.) Troubleshooting a DECreepeater 90FA in a DEChub 90 Backplane

If...	Then...	Do this...
No traffic is received from or by an external device connected to a fiber port with both fiber-link and port status LEDs on.	If the fiber-link and status LEDs both come on	Connect the transmit channel of the port to the external equipment.
	If the port status LED fails to remain on	Ensure that the external equipment is operating properly. Replace the equipment with a known good device.
	If the port status LED fails to remain on, the port transmitter may be sending the idle signal, but may not be passing data.	Replace the repeater.
	It is possible that the external device is not receiving the idle signal from the repeater.	Use a single cable to loop the transmit channel of the port in question to the receive channel of another repeater port.
The port 2 status LED is off.	If the fiber-link monitor LED of the receiving port lights, the idle signal is present.	Check the cable to the external device, and check the external device for correct operation.
	If the fiber-link LED of the receiving port does not come on	Replace the cable with a known good cable.
	If the fiber-link LED of the receiving port still fails to come on	Replace the repeater.
	Port 2 is either segmented or the LED is defective.	Check to see if the port 2 status LED is defective. Remove all front panel connections. Power the repeater off and on by reseating the unit in the DEChub 90. Ensure that the port 2 status LED lights. (On an active DEChub 90, the light will come on momentarily.)

(continued on next page)

Table 5–4 (Cont.) Troubleshooting a DECreepeater 90FA in a DEChub 90 Backplane

If...	Then...	Do this...
	If port 2 status LED does not light, at least momentarily	Replace the repeater.
	If port 2 status LED does light, even if only momentarily	Restore all port connections on the repeater.
	Check the port 0 status LED. If the port 0 status LED is off	Check to see that the repeater is properly installed in the DEChub 90. Using previous troubleshooting steps, ensure that the port 0 status LED and network activity LED are functioning before troubleshooting port 2.
	If the repeater is properly installed in the DEChub 90 and the port 2 status LED goes off, then it is likely that port 2 is segmented. Correction of the segmentation fault should correct the problem.	Check the AUI connection. Ensure that the cable is properly connected and the slide latches are secured.
	If the AUI connection is secure	Check that the MAU is being powered by the repeater. (Most MAUs have a Power OK LED.)
	If the MAU is not powered by the repeater	Replace the repeater.
	If the MAU is powered by the repeater, the fault is probably due to an improper MAU connection to the medium.	Ensure that the medium is correctly attached and that it is properly terminated. Correction of the medium attachment should resolve the problem.

A

Specifications and Parts List

This appendix provides the specifications and parts list for the DECRepeater 90FA repeater.

Specifications for the DECRepeater 90FA are divided into the following categories:

- Physical dimensions
- Environmental (operating and shipping) specifications
- Power specifications

Table A–1 lists the physical dimensions of the DECRepeater 90FA.

Table A–1 Physical Dimensions

Dimension	Measurement
Height	3.5 cm (1.4 in)
Width	28.0 cm (11.0 in)
Depth	14.0 cm (5.5 in)
Weight	.77 kg (1.7 lb)

Table A–2 lists the operating environment specifications for the DECrepeater 90FA.

Table A–2 Operating Environment

Condition	Value
Temperature	5°C to 50°C (41°F to 122°F)
Maximum rate of change	20°C/hr (36°F/hr)
Relative humidity	10% to 95% (noncondensing)
Wet-bulb temperature	32°C (90°F) maximum
Dew point	2°C (36°F) minimum
Altitude	Sea level to 2.4 km (8000 ft)
Air flow	Convectively cooled. A minimum of 10 cm (4 in) of space must be provided on both ends of the unit for adequate air flow.

The DECrepeater 90FA is designed to operate in an office environment or equipment room environment such as telephone closets or satellite equipment rooms. It is not intended to operate in an air plenum.

Table A–3 lists the shipping environment specifications for the DECrepeater 90FA.

Table A–3 Shipping Environment

Condition	Value
Temperature	-40°C to 66°C (-40°F to 151°F)
Relative humidity	10% to 95% (noncondensing)
Altitude	Sea level to 4.9 km (16,000 ft)

Table A-4 lists the power specifications for the DECrepeater 90FA.

Table A-4 Power Specifications

Specification	Value
Voltage (domestic)	104 Vac to 128 Vac (nominal 120 Vac)
Voltage (international)	208 Vac to 256 Vac (nominal 240 Vac)
AC cord length	6 ft
Current at 120 V	.25 A
Current at 240 V	.125 A
Frequency	50 Hz to 60 Hz
Power consumption	9 W
Output voltage 1	5.1 Vdc
Output voltage 2	12.0 Vdc
DC cord length	8 ft
Output current	1.8 A

The DECrepeater 90FA features either a self-contained power supply or self-contained power supply and power cord option.

Table A-5 lists the DECrepeater 90FA voltage and current specifications.

Table A-5 DECrepeater 90FA Input

Specification	Value
Input voltage	4.75 to 5.25 Vdc, 12.0 Vdc
Input current	1.7 A

AUI Connector Pin Assignments

The following table shows the assignment of circuits to connector pins in accordance with the IEEE 802.3 standard.

Pin	Circuit	Use
3	DO-A	Data Out circuit A
10	DO-B	Data Out circuit B
11	DO-S	Data Out circuit Shield
5	DI-A	Data In circuit A
12	DI-B	Data In circuit B
4	DI-S	Data In circuit Shield
7	CO-A	Control Out circuit A
15	CO-B	Control Out circuit B
8	CO-S	Control Out circuit Shield
2	CI-A	Control In circuit A
9	CI-B	Control In circuit B
1	CI-S	Control In circuit Shield
6	V _C	Voltage Common
13	VP	Voltage Plus
14	VS	Voltage Shield
Shell	PG	Protective Ground (Conductive Shell)

Note

Voltage Plus and Voltage Common use a single, twisted-pair cable in the AUI cable.

Parts List

Table A-6 lists the replacement parts for a DECrepeater 90FA.

Table A-6 Parts List

Replacement Part	Part Number
DECrepeater 90FA	DEFAR-MA
Fiber-optic cables	BN24E series
Power supply (120/240 Vac)	H7827-AA

B

Management Details

This appendix supplements the management information in Chapter 4; it provides the following information for managing a DECreepeater 90FA in a DEChub backplane:

- Designating a hub manager
- Annotating the bridge address table
- Using the work group bridge address table for work group management

Designating a Hub Manager

The protocol used on the DEChub management bus allows for only a single manager unit to access the management bus. When a DECbridge 90 series unit is first powered up or reset, the bridge waits 60 seconds before it is established as the designated hub manager. This delay ensures that there is no other manager unit in use in the hub.

During the 60 seconds, you cannot remotely manage the DECreepeater 90FA. This restriction does not apply to the repeaters themselves. A repeater inserted into the hub is immediately manageable by whatever unit is currently the designated hub manager.

If you receive the following message after a DECbridge unit has been running for 60 seconds, then there is something wrong.

The DECbridge unit is not the designated hub manager.

When this message appears, check the following:

- If you are using two hubs, be sure that the BNE16 or DECconnet office cable is wired correctly, and that it is not shorted or broken.
- If you are using only one hub, the MMJ connector should be disconnected.

Only one DECbridge unit is allowed in the hub. If more than one is inserted, only one is able to manage the repeaters. The other unit issues the message.

If you do *not* want a specific DECbridge 90 series unit to be the designated hub manager, use the `DEFINE BRIDGE HUB_MANAGEMENT DISABLE` command to disable the hub management features.

You can use the `SHOW REPEATER` and `SET` or `SHOW PORT` commands without restriction once the DECbridge unit is the designated hub manager. There is, however, an additional delay before the `SHOW ADDRESS` command has complete information.

The `DEFINE` commands do not take effect until the next `SET ALL` or `RESET` bridge commands are used. To have the command take effect immediately, you must also issue the corresponding `SET` command.

Annotating the Bridge Address Table

The DECbridge 90 series unit `SHOW ADDRESS` command lists the repeater slot number and port number for every station in the work group that is connected to the same DEChub with a repeater. However, when changes are made to the network topology, there is a time lapse before the changes appear in the bridge address table. The algorithm for creating this information for every station in the work group is as follows:

- Tell the repeaters to wait for a message from this station.
- Wait as long as 90 seconds for the station to transmit a message.
- Ask the repeaters what port the message came from.

If a station does not transmit a message within 90 seconds, the algorithm proceeds to the next station. In a typical network situation, this information is complete in a few minutes. After a bridge is newly installed or reset, this information should be complete after approximately 10 minutes of operation.

If some stations do not often transmit messages, the DECbridge can hang on those stations as long as 90 seconds each before going to the next one. If you add a station or move a station to another port, it could take about 10 minutes before the `SHOW ADDRESS` command recognizes this move.

If you remove a station from the network entirely, it should take a full address age time (default is 30 minutes) for the DECbridge unit to notice the removal. If you remove several stations at once, the DECbridge unit hangs on each of these stations for 90 seconds, until they age out of the bridge address database. In this case, it usually takes the full address age time (30 minutes) before the port number annotations are complete.

As a worst case example, if it takes 60 seconds for each of the recommended 200 stations to transmit a message, it could take 200 minutes to complete the address database annotations. However, the DECbridge 90 unit tries to expedite the transmission as follows:

- If the station remains quiet after waiting 30 seconds for a message, the DECbridge unit attempts to generate a response using the IEEE XID request.
- If the IEEE XID request fails, the DECbridge unit tries a MOP system-ID request.

For these reasons, the DECbridge unit never hangs for more than 30 seconds on an IEEE conforming station, or for more than 60 seconds on any Digital station that predates the IEEE specifications. If you are monitoring messages and protocols on your work group Ethernet, you occasionally see these messages.

Using the WGB Address Table for Work Group Management

The work group bridge Ethernet address table is dynamic: Ethernet addresses are added to the table when a device first transmits on the network; addresses are removed when a device does not retransmit for a user-specified period, from 1 to 32767 seconds (about 10 hours). The default is 15 minutes. When a device is learned or relearned after it has timed out, the address is listed in the lowest empty entry of the address table.

This continuous learning, timeout, and relearning of the Ethernet addresses means that devices in a particular work group may or may not be in the address table at any moment. If they are in the address table, they may not be in a consistent database location. Devices such as personal computers or laptop computers that are removed and reconnected elsewhere, timeout from the address table. When the device is reconnected, the addresses for these devices are stored in a different address table location.

Because the address table is dynamic, the network manager cannot easily compare printouts of the work group bridge address table to determine work group changes on a day-to-day or week-to-week basis.

C

Related Documentation

This appendix lists related documentation and provides ordering information.

Document Title	Order Number
DECbridge 90 Owner's Manual	EK-DEWGB-OM
DECbridge 90FL Owner's Manual	EK-DEWGF-OM
DEChub 90 Owner's Manual	EK-DEHUB-OM
Open DECconnect Building Wiring Components and Application Catalog	EB-K2407-42
DECconnect System Planning and Configuration Guide	EK-DECSY-CG

Ordering Information

Customers may order documents by phone or mail.

Continental USA and Puerto Rico

Call 1-800-258-1710 or send mail to:

Digital Equipment Corporation
Peripherals and Supplies Group
P.O. Box CS2008
Nashua, NH 03061

New Hampshire, Alaska, and Hawaii

Call 1-603-884-6660.

Outside the USA and Puerto Rico

Send mail to:

Digital Equipment Corporation
Attn: Accessories and Supplies Business Manager
c/o local subsidiary or Digital-approved distributor

Digital Personnel

Digital personnel may order these documents from:

Digital Equipment Corporation

444 Whitney Street

Northboro, MA 01532

Attn: Publishing and Circulation Services (NR03/W3)

Order Processing Section

Index

A

- Address number, 4-6
- Attached Unit Interface (AUI)
 - See AUI.
- AUI
 - connector, 1-3
 - connector pin assignments, A-4
 - port, 1-1
- AUI status indicator, 1-3

B

- Backplane, 1-1
 - connector, 1-3
 - installation, 3-6 to 3-7
- Bridge names
 - maximum length, 4-3

C

- Commands
 - abbreviations, 4-4
 - additional, 4-17
 - arguments and parameters, 4-5
 - console carrier, 4-4 to 4-6
 - parameter descriptions, 4-6
- Configuration rules
 - DECrepeater 90FA, 2-1 to 2-5
 - extended LAN, 2-4
 - network, 2-2
 - number of repeaters, 2-1
 - segment length, 2-1

Connections

- backplane, 3-6 to 3-7
- power supply, 3-4
- standalone, 3-4 to 3-5
- ThinWire, 3-4

Connector

- AUI, 1-3
- backplane, 1-3
- fiber-optic receive cable, 1-3
- fiber-optic transmit cable, 1-3
- port 0 network (BNC), 1-3
- power, 1-3

Console carrier

- commands, 4-4 to 4-6
 - to establish a session from ULTRIX, 4-3 to 4-4
 - to establish a session from VMS, 4-2 to 4-3
- user interface, 4-4

Constraints

- installed fiber, 2-5
- network, 2-2
- segment length, 2-1

D

- DC OK indicator, 1-3
- DEChub 90 backplane
 - See backplane.
- DECrepeater 90FA
 - backplane troubleshooting, 5-8 to 5-13
 - configuration rules, 2-1
 - environmental specifications, A-1

DECrepeater 90FA (cont'd)

- features, 1-1
- managed in backplane, 1-1
- operating environment, A-2
- physical dimensions, A-1
- power specifications, A-3
- replacement parts, A-5
- shipping environment, A-2
- standalone troubleshooting, 5-3 to 5-7
- unmanaged as standalone, 1-1
- voltage specifications, A-3

E

Error messages

- DECbridge 90, 4-18 to 4-20

Ethernet

- addresses, 4-2
- arbitrary address, 4-3
- circuit names, 4-2

F

Fiber-link status indicator, 1-3

Fiber-optic receive connector, 1-3

Fiber-optic transmit connector, 1-3

H

Help command, 4-4

Hub slot number, 4-6

I

IEEE 802.3

- AUI compliant, 1-1
- CSMA/CD networks, 1-1
- FOIRL compliant, 1-1
- multisegment LANs, 2-1
- ThinWire compliant, 1-1

Indicators

- AUI status, 1-3
- DC OK, 1-3
- fiber-link status, 1-3
- network activity, 1-3
- port 0 status, 1-3

Indicators (cont'd)

- port 1 status, 1-3

Installation

- backplane, 3-6 to 3-7
- environmental requirements, 3-1
- standalone, 3-1
- tool, 3-1
- wall-mount, 3-2 to 3-5

L

LEDs and connectors, 1-2 to 1-3

M

Maintenance Operations Protocol (MOP)

See MOP.

Management

- annotating bridge address, B-2 to B-3
- components, 4-1
- designating a hub manager, B-1 to B-2
- from remote network, 4-14
- port partitioning, 4-14
- problems, 4-16 to 4-17
- session, 4-15 to 4-16
- techniques, 4-13
- topology map, 4-14
- using bridge address table, B-3

MOP

- access from ULTRIX, 4-3
- access from VMS, 4-2
- functions, 4-1 to 4-4

N

Network (BNC) connector, 1-3

Network activity indicator, 1-3

Network Control Program (NCP), 4-2

Networks

- 10Base2, 1-1
- 10Base-FL, 1-1
- CSMA/CD, 1-1

P

Password

- at login, 4-3
- defining, 4-3
- length, 4-7
- security, 4-3

Port

- AUI, 1-1
 - fiber-optic, 1-1
 - number, 4-6
 - ThinWire, 1-1
- Port 0 network (BNC) connector, 1-3
- Port 0 status indicator, 1-3
- Port 1 status indicator, 1-3
- Port partitioning, 5-1
- Power supply
- auto-ranging, 1-1
 - connector, 1-3
 - output voltage, A-3
 - 120 Vac, 1-1
 - 240 Vac, 1-1

R

Repeaters

- disabling ports, 4-8

- port numbers, 4-10
- show command, 4-10
- slot numbers, 4-10

S

- Standalone installation, 3-1 to 3-5

T

Troubleshooting

- DECrepeater 90FA in DEChub 90
 - backplane, 5-8 to 5-13
- DECrepeater 90FA standalone, 5-3 to 5-7

U

- ULTRIX access to MOP, 4-3

V

- VMS access to MOP, 4-2

W

- Wall-mount installation, 3-2 to 3-5

