

DEC Commserver 100/150 Installation/Owner's Manual

Order Number EK-DSPAA-IN-001

This manual provides information for installing and testing DEC Commserver 100 and DEC Commserver 150 hardware. It also includes procedures for troubleshooting hardware installation problems.

Revision/Update Information: This is a new manual. **PRELIMINARY VERSION**

Digital Equipment Corporation

March 1991

The information in this document is subject to change without notice and should not be construed as a commitment by Digital Equipment Corporation. Digital Equipment Corporation assumes no responsibility for any errors that may appear in this document.

No responsibility is assumed for the use or reliability of software on equipment that is not supplied by Digital Equipment Corporation or its affiliated companies.

Restricted Rights: Use, duplication, or disclosure by the U.S. Government is subject to restrictions set forth in subparagraph (c)(1)(ii) of the Rights in Technical Data and Computer Software clause at DFARS 252.227-7013.

Copyright ©Digital Equipment Corporation 1991

The following are trademarks of Digital Equipment Corporation:

CDA	DECUS	UNIBUS
DDIF	DEC	DECwindows
DECimage	PDP	VMS

digital[™]

This document was prepared using VAX DOCUMENT, Version 1.2

Contents

Preface

vii

Chapter 1 INTRODUCTION

1.1	DEC Commserver 100	1-1
1.2	DEC Commserver 150	1-4

Chapter 2 CHECKING SHIPPING CONTENTS

2.1	DEC Commserver 100	2-1
2.2	STANDARD ACCESSORIES	2-3
2.3	DEC Commserver 150	2-4
2.4	RACKMOUNT KITS	2-6

Chapter 3 SITE VERIFICATION

3.1	ARRANGING FOR SOFTWARE INSTALLATION	3-2
3.2	ENVIRONMENT	3-5
	3.2.1 DEC Commserver 100 Physical Requirements	3-5
	3.2.2 DEC Commserver 150 Physical Requirements	3-5
3.3	CABLING REQUIREMENTS	3-6
3.4	PREINSTALLATION CHECKS	3-7

Chapter 4 INSTALLATION

4.1	INSTALLATION OVERVIEW	4-1
4.2	INSTALLING THE COMMSERVER HARDWARE	4-2
	4.2.1 Configuring Commserver for Standard or ThinWire Ethernet LAN	4-2
	4.2.2 Connecting the Console Terminal	4-4

4.2.3	Testing the Commserver Hardware	4-6
4.2.3.1	Connecting AC Power to the Commserver	4-6
4.2.3.1.1	Connecting Power to the DEC Commserver 100	4-6
4.2.3.1.2	Connecting Power to the DEC Commserver 150	4-7
4.2.3.2	Testing the Hardware	4-9
4.2.4	Connecting to the Ethernet Network	4-13
4.2.4.1	Connecting to a Standard Ethernet LAN	4-13
4.2.4.2	Connecting to a ThinWire Ethernet LAN	4-15
4.2.4.3	Installing the ThinWire Ethernet Strain-Relief Clamp	4-17
4.2.5	Installing the Front Cover (DEC Commserver 150, Office Model Only)	4-19
4.3	Preparing the Commserver for Downloading of Software	4-21

Chapter 5 WHAT TO DO IF YOU HAVE PROBLEMS

Appendix A CONTROLS, INDICATORS, AND CONNECTORS

A.1	DEC Commserver 100	A-1
A.2	DEC Commserver 150	A-5

Appendix B SPECIFICATIONS

Appendix C RACKMOUNT HARDWARE INSTALLATION

C.1	REMOVING THE PLASTIC COVERS	C-1
C.2	ATTACHING THE MOUNTING BRACKETS	C-3
C.3	MOUNTING THE DEC Commserver 100 INTO THE RACK	C-5

Appendix D ICP1622T SERIES MODULE INSTALLATION AND VERIFICATION

D.1	INTRODUCTION	D-1
D.2	SIMPACT MODULES AND DISTRIBUTION HARDWARE	D-2
D.3	INSTALLATION	D-3
D.4	VERIFICATION	D-5
D.5	REMOVING A LOAD MODULE	D-6

Appendix E POWER CORDS/ORDER NUMBERS

Examples

4-1	Command to Display Ethernet Address	4-12
-----	---	------

Figures

1-1	DEC Commserver 100	1-2
1-2	DEC Commserver 100 Typical Configuration	1-3
1-3	DEC Commserver 150 (Rackmount Model)	1-5
1-4	DEC Commserver 150 (Office Model)	1-6
1-5	DEC Commserver 150 Typical Configuration	1-7
2-1	DEC Commserver 100 Shipping Box Contents	2-2
2-2	Commserver Accessory Kit	2-3
2-3	DEC Commserver 150 (Office Model) Shipping Box Contents	2-4
2-4	DEC Commserver 150 (Rackmount Model) Shipping Box Contents	2-5
2-5	DEC Commserver 100 Rackmount Kit	2-6
2-6	BA213 Rackmount Kit	2-7
3-1	Ethernet and Serial Number Labels, Location	3-3
3-2	Example, Filling Out Hardware Portion of Identification Card	3-4
4-1	Ethernet Selector	4-3
4-2	Connecting a Console Terminal	4-5
4-3	Connecting Power to the DEC Commserver 100	4-6
4-4	Connecting Power to the DEC Commserver 150	4-8
4-5	Initial Power-Up of the DEC Commserver 100	4-10
4-6	Initial Power-Up of the DEC Commserver 150	4-11
4-7	Typical Commserver Power-Up Self-Test Display	4-12
4-8	Connecting to the Standard Ethernet LAN	4-14
4-9	Connecting to the ThinWire Ethernet LAN	4-16
4-10	Installing the ThinWire Strain-Relief Clamp	4-18
4-11	Unlocking the Front Cover (Office Model)	4-19
4-12	Installing the Front Cover (Office Model)	4-20
A-1	DEC Commserver 100 Controls, Indicators, and Connectors	A-4
A-2	DEC Commserver 150 Controls, Indicators, and Connectors	A-7
C-1	Removing Plastic Covers	C-2
C-2	Removing Screws from Metal Cover	C-3
C-3	Attaching the Mounting Brackets	C-4
C-4	Mounting the DEC Commserver 100 into the Rack	C-6
D-1	Routing Cables in the DEC Commserver 150 (Office Model)	D-4
D-2	Indication when Self Test Is Successful	D-5
D-3	Removing the Load Module	D-7

Tables

3-1	Maximum Cable Lengths	3-6
5-1	Troubleshooting Power-on Problems	5-1
A-1	DEC Commserver 100 Controls, Indicators, and Connectors	A-2
A-2	DEC Commserver 150 Controls, Indicators, and Connectors	A-5
B-1	DEC Commserver 100 Specifications	B-2
B-2	DEC Commserver 150 Specifications	B-4
D-1	Module/Kit Order Number Cross Reference Table	D-2
E-1	Power Cords/Order Numbers	E-1

Preface

This manual provides the trained technical user with information on how to install and operate DEC Commserver 100 and DEC Commserver 150 communication servers. In this manual, these communication servers will be referred to as Commservers unless the information applies only to one of the two servers.

This manual provides hardware information only. For information on the installation and operation of the DEC Commserver software, refer to the *DEC Commserver For VMS Installation Manual* (AA-PE92A-TE) or the *DEC Commserver For VMS User's Guide* (AA-PE91A-TE).

How to Use This Manual

Before you install a Commserver, it is recommended that you read Chapters 1, 2, and 3. These chapters provide a functional overview of the Commserver and the installation process, including important site verification information. Chapter 4 provides the procedures to install and verify the Commserver installation. If problems occur during verification, refer to the troubleshooting procedures in Chapter 5. The appendices offer additional information that may be useful during installation.

Structure of This Document

This document is a combination installation guide and owner's manual, and is organized as follows:

Chapter 1, INTRODUCTION — Provides a general description of the DEC Commserver 100 and DEC Commserver 150, an overview of the hardware connection (block diagram level) to the Ethernet network and the fan out to other devices by way of a distribution box(es).

Chapter 2, CHECKING SHIPPING CONTENTS — Describes the shipping configuration of the DEC Commserver 100 and DEC Commserver 150, and how to obtain help if there are any items missing or damaged in shipment.

Chapter 3, SITE VERIFICATION — Provides information concerning items that must be considered before installing the Commserver.

Chapter 4, INSTALLATION — Describes how to install, power up, and verify the Commserver installation.

Chapter 5, WHAT TO DO IF YOU HAVE PROBLEMS — Provides help in isolating and solving problems that might occur during the power-on self test.

Appendix A, CONTROLS, INDICATORS, AND CONNECTORS — Describes the controls and indicators on the DEC Commserver 100 and DEC Commserver 150.

Appendix B, SPECIFICATIONS — Provides the specifications for the DEC Commserver 100 and DEC Commserver 150.

Appendix C, RACKMOUNT HARDWARE INSTALLATION — Provides instructions on how to rack mount the DEC Commserver 100 and the DEC Commserver 150.

Appendix D, ICP1622T SERIES MODULE INSTALLATION AND VERIFICATION — Provides installation notes for Simpack ICP1622T and EXC1612T modules.

Appendix E, POWER CORDS/ORDER NUMBERS — Provides a list of optional power cords along with order numbers.

Related Documents

Contact your Digital sales representative for ordering information concerning the following related documents:

- *BA200-Series Chassis Rack and Wall Mount Installation* (EK-BA200-IN)
- *DEC Commserver For VMS Installation Manual* (AA-PE92A-TE)
- *DEC Commserver For VMS User's Guide* (AA-PE91A-TE)

Notes, Cautions and Warnings

When notes, cautions and warnings are used in this document, they highlight specific types of information as follows:

NOTE Calls the attention to any item of information that may be of special importance to the reader.

CAUTION Contains essential information to avoid damage to the equipment.

WARNING Contains essential information for the safety of the user.

FCC USER STATEMENT

NOTICE:

This equipment generates, uses, and may emit radio frequency energy. The equipment has been type tested and found to comply with the limits for a Class A computing device pursuant to Subpart J of Part 15 of FCC rules, which are designed to provide reasonable protection against such radio frequency interference. Operation of this equipment in a residential area may cause interference in which case the user at his own expense will be required to take whatever measures may be required to correct the interference.

この装置は、商工業地域で使用される第一種情報装置です。住宅地域
又はその隣接した地域で使用するとラジオ、テレビジョン受信機等に受信
障害を与えることがあります。 V C C I - 1 *

NOTE

To satisfy the electromagnetic compatibility (EMC) requirements, customer supplied data cables must be shielded.

Für Bundesrepublik Deutschland und Berlin (West) For Federal Republic of Germany and West Berlin Pour la République fédérale d'Allemagne et Berlin Ouest Hochfrequenzgerätezulassung und Betriebsgenehmigung Bescheinigung des Herstellers/Importeurs Hiermit wird bescheinigt, daß die Einrichtung in Übereinstimmung mit den Bestimmungen der DBP-Berfügung 523/1969, Amtsblatt 113/1969, und Grenzwertklasse "A" der VDE0871, funkentstört ist. Das Zentralamt für Zulassungen im Fernmeldewesen der Deutschen Bundespost (DBP), hat diesem Gerät eine FTZ-Serienprüfnummer zugeteilt. Betriebsgenehmigung Hochfrequenzgeräte dürfen erst in Betrieb genommen werden, nachdem hierfür von dem für den vorgesehenen Aufstellungsort zuständigen Fernmeldeamt mit Funkstörungenmeßstelle die Genehmigung erteilt ist. Als Antrag auf Erteilung einer Genehmigung dient eine Anmeldepostkarte (Anhang des Handbuches) mit Angabe der FTZ-Serienprüfnummer. Der untere Teil der Postkarte ist vom Betreiber zu vervollständigen und an das örtliche Fernmeldeamt zu schicken. Der obere Teil bleibt beim Gerät. Betreiberhinweis Das Gerät wurde funktechnisch sorgfältig entstört und geprüft. Die Kennzeichnung mit der Zulassungsnummer bietet Ihnen die Gewähr, daß dieses Gerät keine anderen Fernmeldeanlagen einschließlich Funkanlagen stört. Sollten bei diesen Geräten ausnahmsweise trotzdem, z.B. im ungünstigsten Fall beim Zusammenschalten mit anderen EDV- Geräten, Funkstörungen auftreten kann das im Einzelnen zusätzliche Funkstörungsmaßnahmen durch den Benutzer erfordern. Bei Fragen hierzu wenden Sie sich bitte an die örtlich zuständige Funkstörungenmeßstelle Ihres Fernmeldeamtes. Externe Datenkabel Sollte ein Austausch der von Digital Spezifizierten Datenkabel nötig werden, muß der Betreiber für eine einwandfreie Funkentsörung sicherstellen, daß Austausch kabel im Aufbau und Abschirmqualität dem Digital Originalkabel entsprechen. Kennzeichnung Die Geräte werden bereits in der Fertigung mit der Zulassungsnummer gekennzeichnet und mit einer Anmeldepostkarte versehen. Sollte Kennzeichnung und Anmeldepostkarte übergangsweise nicht mit ausgeliefert werden kontaktieren Sie bitte das nächstgelegene Digital Equipment Kundendienstbüro.

Chapter 1

INTRODUCTION

This chapter describes the DEC Commserver 100 and the DEC Commserver 150 communication servers, and provides an overview of the hardware connection to an Ethernet network and other devices by way of optional communication modules and distribution hardware.

1.1 DEC Commserver 100

The DEC Commserver 100 (DSPAA-AA) (shown in Figure 1-1) is a hardware/software dependent server used in a Local Area Network (LAN). The Commserver connects one or more VAX/VMS hosts on an Ethernet network to various devices such as modems, computers, and terminals, which may use different communication protocols.

Depending on the protocol used, the DEC Commserver 100 can connect up to 16 communications lines to one or more hosts by way of the Ethernet network. This is accomplished using optional modules plugged into one or two of the available slots in the DEC Commserver 100. The modules are then connected by cable to distribution hardware, where the devices are connected.

Figure 1-1: DEC Commserver 100

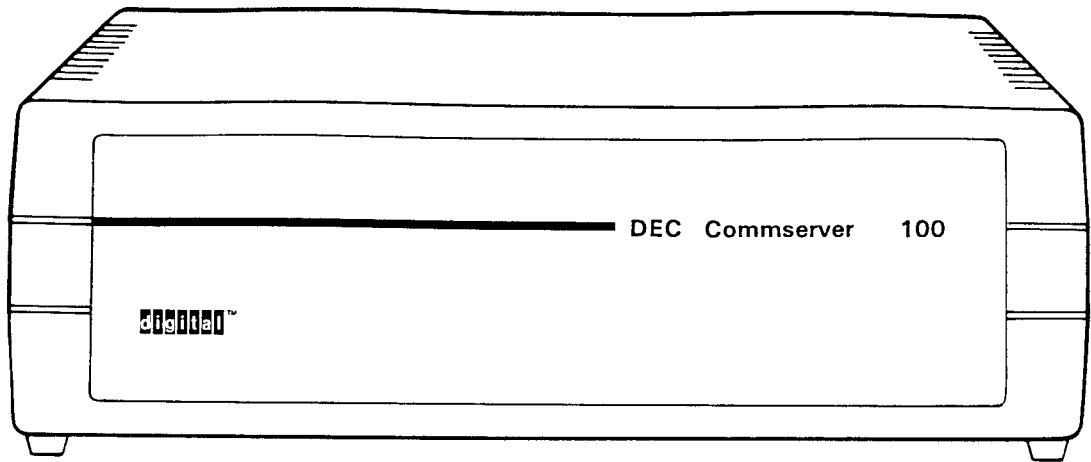

FRONT VIEW

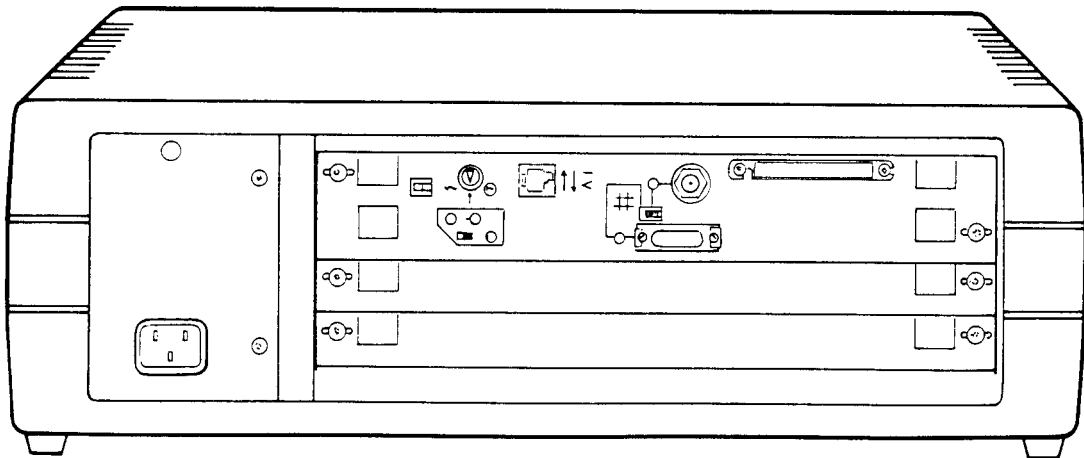

REAR VIEW

CS-8098

Refer to Figure 1-2 for a typical configuration of the DEC Commserver 100 environment.

The DEC Commserver 100 is a table top unit. However, by removing its plastic cover set, it can be installed as a rack mounted unit in a standard 19-inch RETMA† rack cabinet. The DEC Commserver 100 has a line voltage sensor that allows operation at either 120 Vac or 240 Vac. The Commserver is shipped with a power cord for 120 Vac operation. For 240 Vac operation, the user must order the appropriate power cord assembly. For a list of the power cords available from Digital, refer to Appendix E.

Figure 1-2: DEC Commserver 100 Typical Configuration

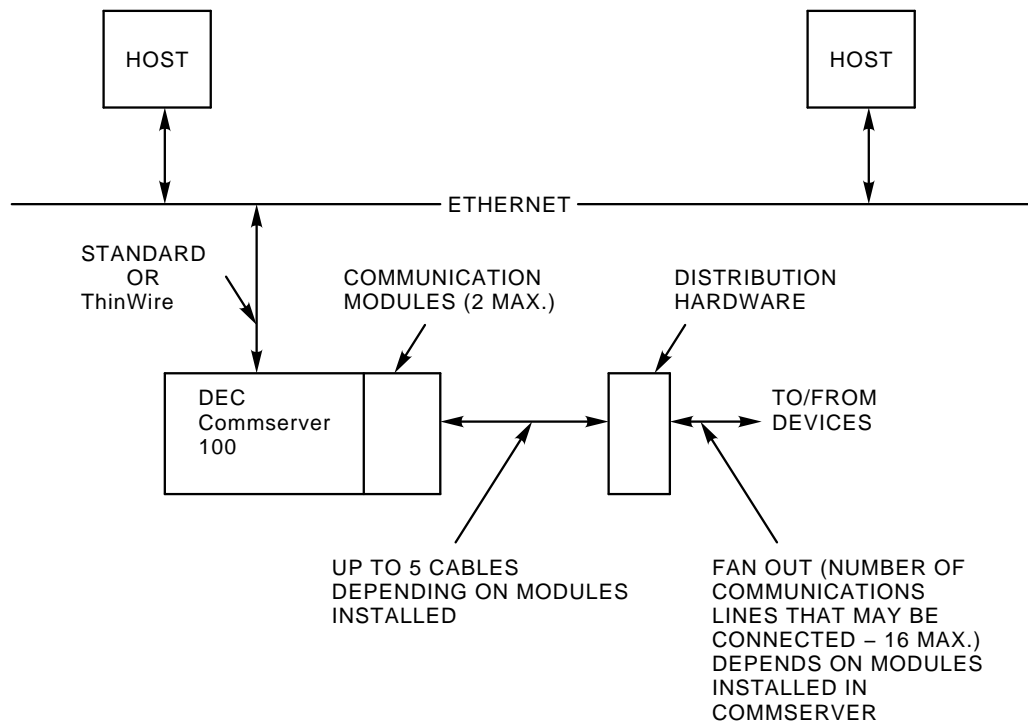

CS-8199

† RETMA racks are standard sized cabinets used by Digital and other major manufacturers of electronic equipment. The cabinet rails, mounting hole patterns, and spacing conform to international standards that allow compatibility with products manufactured by Digital and other major manufacturers.

1.2 DEC Commserver 150

The DEC Commserver 150 provides the same function as the DEC Commserver 100 with a higher fan out capability.

There are two DEC Commserver 150 models. The rackmount model (shown in Figure 1-3) can be installed in a standard 19-inch RETMA rack. The office model (shown in Figure 1-4) comes in a cabinet on castors, and can be placed in an office (or similar) environment.

Each model is available in two versions for 120 Vac and 240 Vac operation:

- 120 Vac, Rackmount model (DSPAB-BA)
- 240 Vac, Rackmount model (DSPAB-BB)
- 120 Vac, Office model (DSPAB-CA)
- 240 Vac, Office model (DSPAB-CB)

The 120 Vac versions are shipped with a power cord. The 240 Vac versions are shipped without a power cord. The user must supply the appropriate power cord assembly. For a list of the power cords available from Digital and their order numbers, refer to Appendix E.

Figure 1-3: DEC Commserver 150 (Rackmount Model)

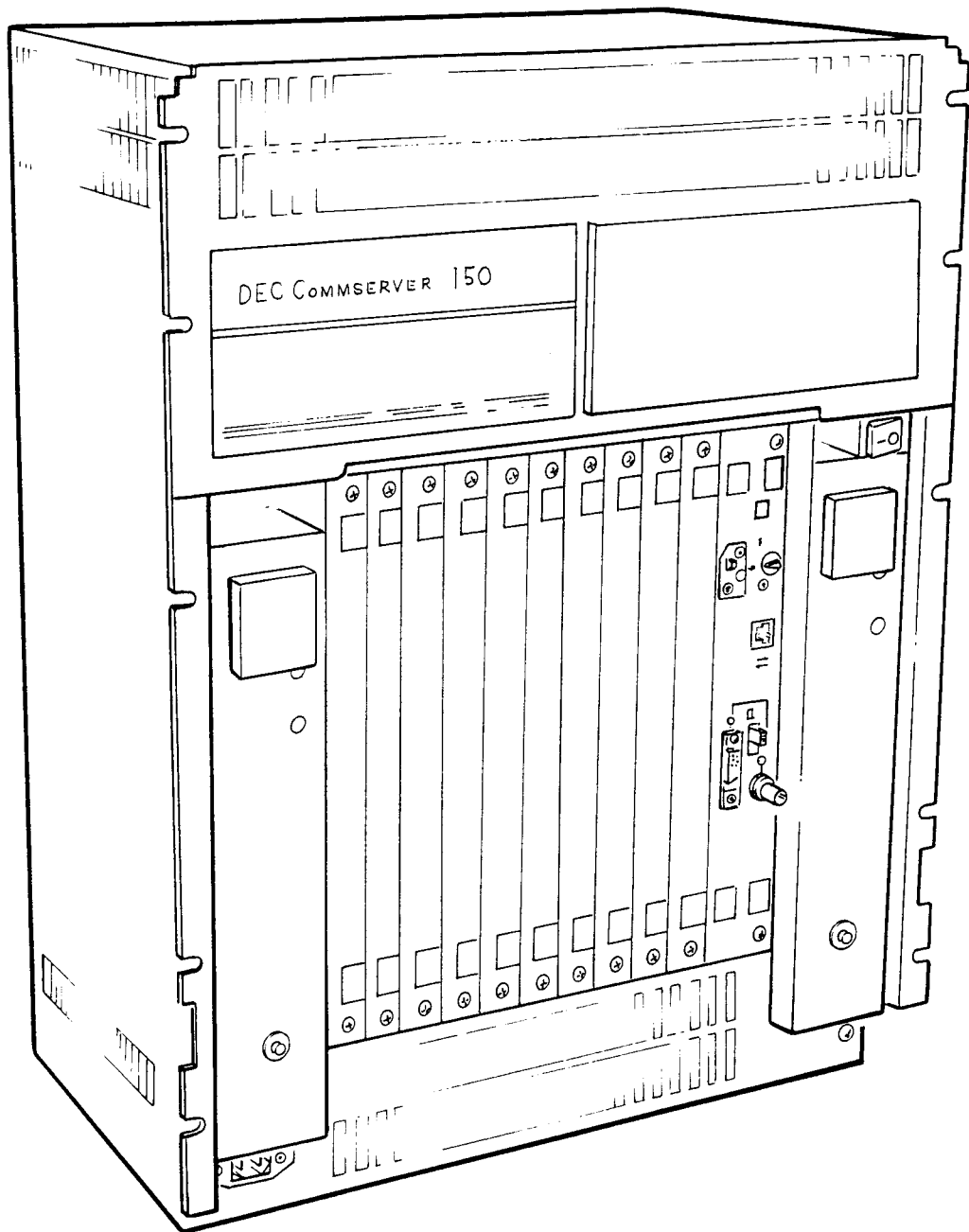

CS-8100

Figure 1-4: DEC Commserver 150 (Office Model)

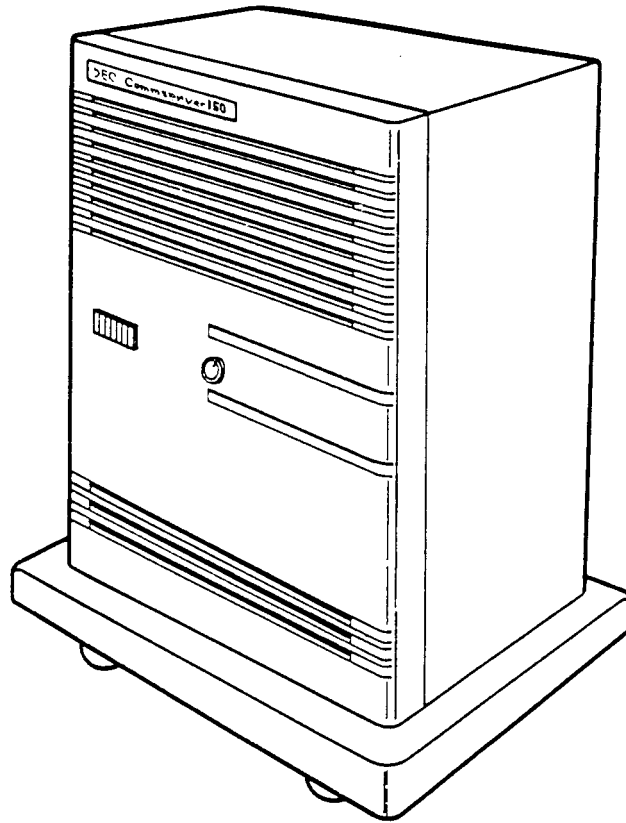

CS-8099

Depending on the protocols used, the DEC Commserver 150 can connect up to 80 communications lines to one or more hosts by way of the Ethernet network. This is accomplished using optional modules plugged into one to ten of the available slots in the DEC Commserver 150. The modules are then connected by cable to optional distribution hardware where the devices are connected.

Refer to Figure 1-5 for a typical configuration of the DEC Commserver 150 environment.

Figure 1-5: DEC Commserver 150 Typical Configuration

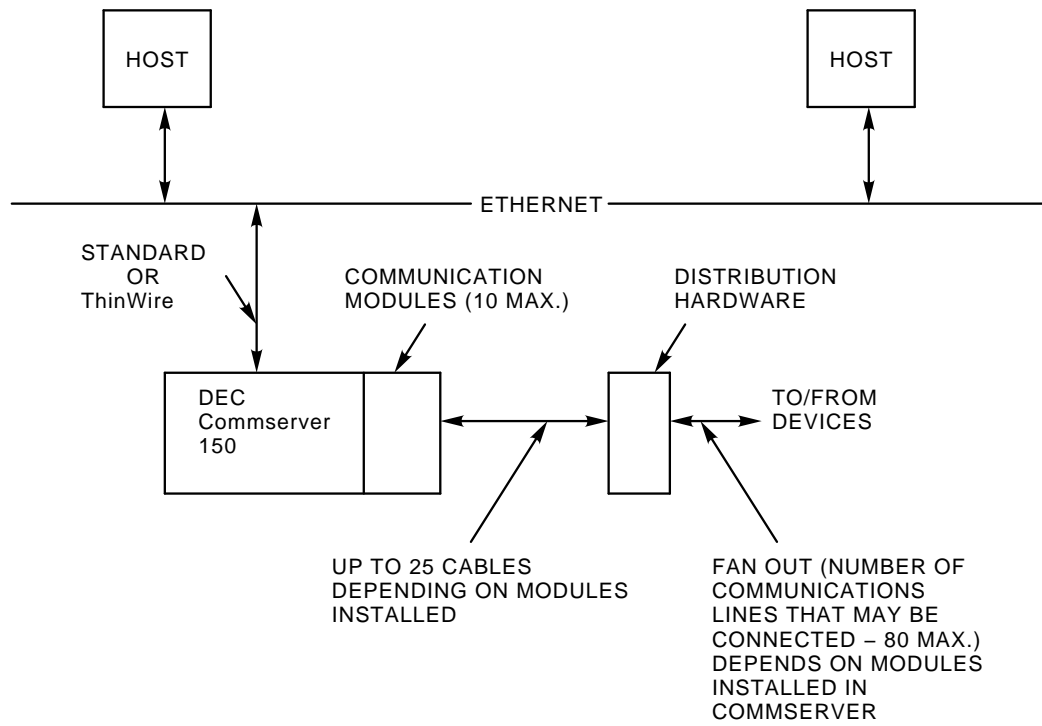

CS-8200

Chapter 2

CHECKING SHIPPING CONTENTS

This chapter contains instructions for checking the shipping contents of the DEC Commserver 100, DEC Commserver 150 (rackmount model), and DEC Commserver 150 (office model).

NOTE

If any items in the shipment are damaged, contact your delivery agent. If any items are missing, contact your Digital Sales Representative.

2.1 DEC Commserver 100

Depending on the optional equipment ordered, a single DEC Commserver 100 shipment can consist of one or more boxes. Check the shipment to ensure that it includes all of the ordered equipment. The DEC Commserver 100 is packed in the shipping box, as shown in Figure 2-1.

NOTE

Save all shipping material in case any items need to be returned.

Figure 2-1: DEC Commserver 100 Shipping Box Contents

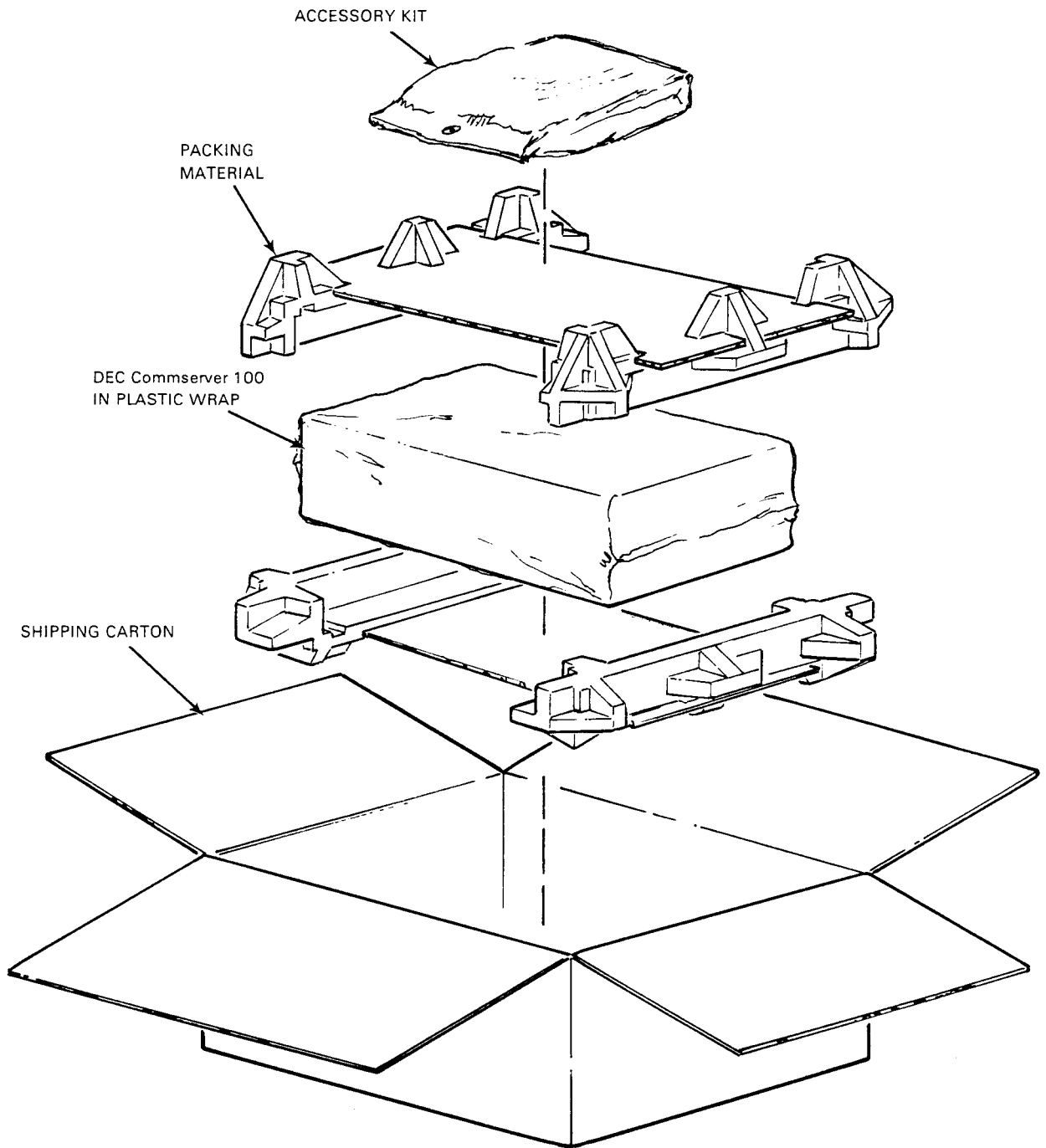

CS-8104

2-2 CHECKING SHIPPING CONTENTS

2.2 STANDARD ACCESSORIES

Check the accessories shipped with the Commserver. The accessories shipped with every Commserver are listed in Figure 2-2. As noted in Figure 2-2, some of the items shipped are only used on a particular Commserver model.

Figure 2-2: Commserver Accessory Kit

- CONFIGURATION LABELS (3) (NOT SHOWN)
- HARDWARE DOCUMENTATION (NOT SHOWN)
- LICENSE PAK (NOT SHOWN)
- VDE POSTCARD (INCLUDED WITH 240 VOLT UNITS) INTENDED FOR USE ONLY IN GERMANY (NOT SHOWN)

- PHILLIPS SCREWDRIVER (NOT SHOWN)

- ThinWire STRAIN-RELIEF CLAMP

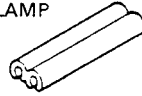

- POWER CORD (120 VOLT ONLY)

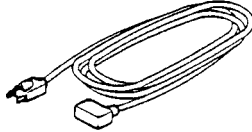

- ETHERNET LOOPBACK CONNECTORS

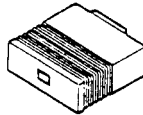

STANDARD

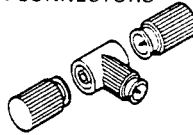

ThinWire (T CONNECTOR AND TWO TERMINATORS)

- 2 ANTI-STATIC KEYS (FOR USE WITH DEC Commserver 150, OFFICE MODEL ONLY)



- H8571-A PASSIVE ADAPTER

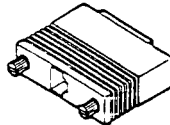

- CONSOLE CABLE

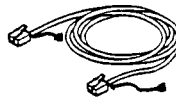

CS-8121

2.3 DEC Commserver 150

Depending on the optional equipment ordered, a single DEC Commserver 150 shipment can consist of one or more boxes. Check the shipment to ensure that it includes all of the ordered equipment. The DEC Commserver 150 (office model) is packed in the shipping box as shown in Figure 2-3. The DEC Commserver 150 (rackmount model) is packed in the shipping box as shown in Figure 2-4.

NOTE

Save all shipping material in case any items need to be returned.

Figure 2-3: DEC Commserver 150 (Office Model) Shipping Box Contents

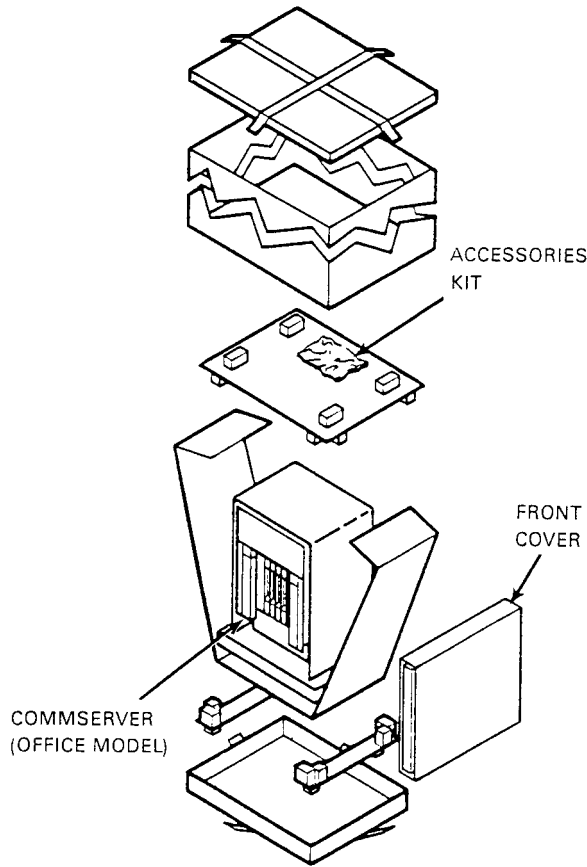

CS-8122

Figure 2-4: DEC Commserver 150 (Rackmount Model) Shipping Box Contents

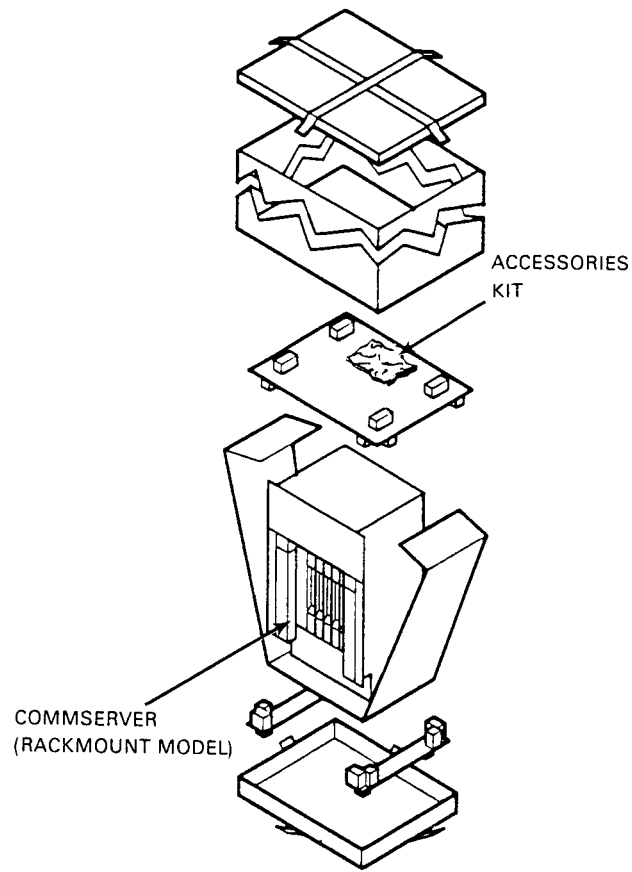

CS-8123

2.4 RACKMOUNT KITS

The DEC Commserver 100 and the DEC Commserver 150 (rackmount model) are each shipped with a rackmount kit in addition to the accessories kit described in Section 2.2. Figure 2-5 shows the contents of the DEC Commserver 100 Rackmount Kit. Figure 2-6 shows the contents of the BA213 Rackmount Kit shipped with the DEC Commserver 150 (rackmount model).

Installation instructions for the DEC Commserver 100 are contained in Appendix C of this manual. Installation instructions for the BA213 Rackmount Kit are provided in the kit.

Figure 2-5: DEC Commserver 100 Rackmount Kit

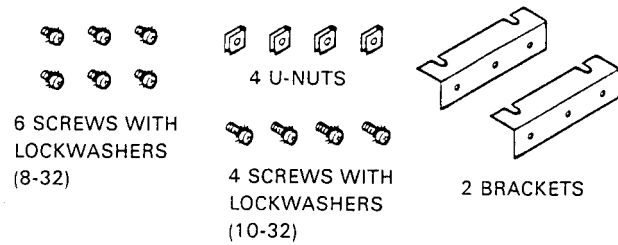

CS-8189

Figure 2-6: BA213 Rackmount Kit

- 2 MOUNTING BRACES

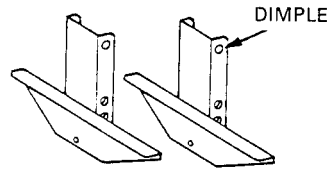

- 10 CLIP NUTS (TINNERMAN NUTS)



- 14 1/2" #10 X 32 TRUSS HEAD, PHILLIPS SCREWS



- INSTALLATION INSTRUCTIONS

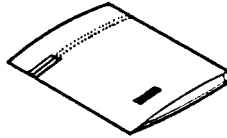

CS-8120

Chapter 3

SITE VERIFICATION

This chapter provides instructions to verify that the preselected installation site meets the requirements of the Commserver being installed. The requirements pertain to the following:

- Arranging for Software Installation
- Environment
- DEC Commserver 100 Installation
- DEC Commserver 150 Installation

The instructions in this chapter assume that the customer has completed the following site preparations steps:

- A Commserver installation site is defined.
- The site meets the environmental requirements of the Commserver. (See Appendix B.)
- An appropriate Ethernet device (standard or ThinWire) is available for connecting the Commserver to the Local Area Network (LAN).
- An appropriate power source is within 1.6 meters (5.5 feet) of the Commserver installation site.

3.1 ARRANGING FOR SOFTWARE INSTALLATION

Before the Commsserver can be fully operational, the software must be installed on a VAX/VMS host computer system on the Ethernet. (The software and its documentation are shipped in a separate box.) To arrange for the software installation, proceed as follows:

1. Locate the serial number and the Ethernet address on separate labels on the Commsserver. See Figure 3-1 for the location of the labels.

Figure 3-1: Ethernet and Serial Number Labels. Location

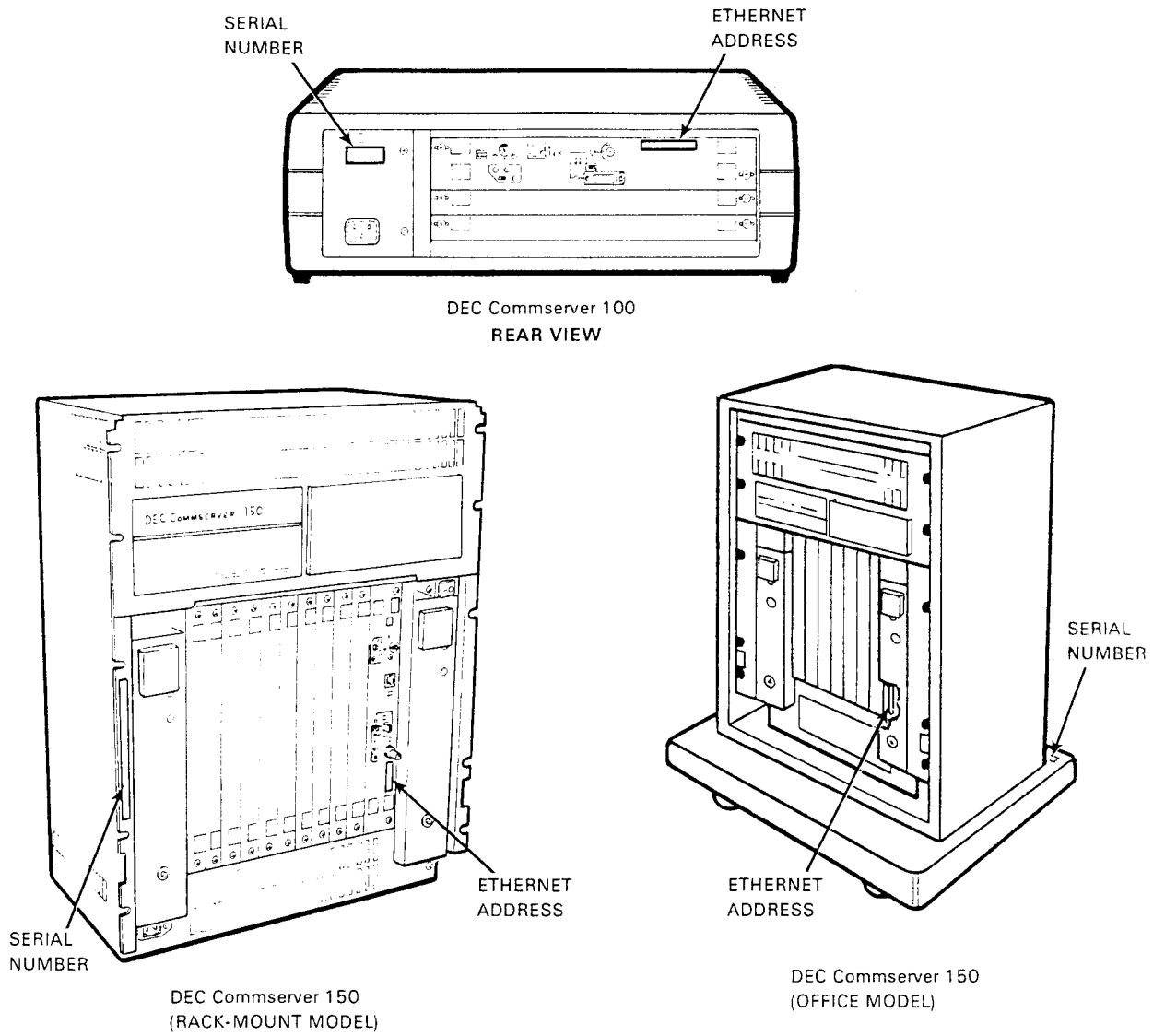

CS-8105

2. Locate the DEC Commserver Identification Card placed at the end of this manual. Copy the following information in the spaces provided on the identification card as shown in Figure 3-2:
 - The serial number of the Commserver
 - The Ethernet address for the Commserver
 - The location of the Commserver (for example: office number, building, or floor)
 - Your name and the date of installation
3. After filling in the information as described above, give the card to the system or network manager to complete. The person installing the software needs this information to configure the Commserver on a load host.

Figure 3-2: Example, Filling Out Hardware Portion of Identification Card

DEC Commserver Identification Card

Hardware Installer

Please copy the serial number and the Ethernet address from the DEC Commserver hardware unit onto this card. Also include your name, the date of the installation, and the location of the hardware unit (for example, office number, building, floor). After completing this information, give this card and the software license to the system/network manager.

Serial number	0	0	0	1	2	3	4	5	6	7							
Ethernet address	0	8	-	0	0	-	2	B	-	1	6	-	0	2	-	E	3
Location	ROOM 85																
Your name	R. SMITH										Date	10 / 15 / 90					

CS-8108

3.2 ENVIRONMENT

The DEC Commserver 100 and the DEC Commserver 150 can operate in an office or computer room environment. Regardless of where the Commserver will be installed, verify that all of the requirements in this section are met before beginning the installation. If a DEC Commserver 100 is being installed, proceed to Section 3.2.1. If installing a DEC Commserver 150, proceed to Section 3.2.2.

3.2.1 DEC Commserver 100 Physical Requirements

The tabletop and rackmount versions of the DEC Commserver 100 have different dimensions. Both versions, however, require additional space for cables, air, and service access.

When determining where to place the DEC Commserver 100, take into consideration its dimensions, weight, and clearance space required. Refer to the DEC Commserver 100 specifications in Appendix B for electrical requirements, environmental limits, and physical dimensions.

When the DEC Commserver 100 is installed on a tabletop, there must be 7.7 centimeters (three inches) on either side of it for air circulation. For a rack installation, there must be nine centimeters (3.5 inches) of space between the DEC Commserver 100 and the device below it in the rack.

At the rear (side with slots) of the DEC Commserver 100, a space of 15.4 centimeters (3.5 inches) is needed for cables, and 123 centimeters (48 inches) for easy service access.

Proceed to Section 3.3.

3.2.2 DEC Commserver 150 Physical Requirements

The office and rackmount models of the DEC Commserver 150 have different dimensions. Both models, however, require additional space for cables, air, and service access.

When determining where to place the DEC Commserver 150, take into consideration its dimensions, weight, and required clearance space. Refer to the DEC Commserver 150 specifications in Appendix B for electrical requirements, environmental limits, and physical dimensions.

If the office model is being installed, there should be at least 123 centimeters (48 inches) of clearance in front of it for service access. Also, make sure that the air vents on the left and right sides (facing unit) of the unit are not blocked.

Proceed to Section 3.3.

3.3 CABLING REQUIREMENTS

Any preinstalled device cables must be long enough so that they can reach and be connected without strain to the Commsserver. Additionally, depending on whether the Commsserver is to be connected to a standard or a ThinWire Ethernet LAN, the following requirements apply:

- Standard Ethernet Connection

The Ethernet cable must reach the Commsserver and must not exceed the maximum length listed in Table 3–1. The table identifies the maximum length according to cable type.

- ThinWire Ethernet Connection

The T connector installed on the ThinWire cable must reach the Commsserver.

Table 3–1: Maximum Cable Lengths

From	To	Maximum Cable Length	Cable Type
Commsserver	Transceiver	50 meters (164 feet)	BNE3x-xx standard Ethernet cable ¹
Commsserver	Transceiver	12.5 meters (41 feet)	BNE4x-xx office Ethernet cable ¹
Commsserver	ThinWire device	185 meters (606.8 feet)	BC16M-xx ThinWire cable
Commsserver	Console Terminal (used for installation only)	7.62 meters (25 feet)	17-01364-02 console cable
Commsserver	Power outlet	1.6 meters (5.5 feet)	Commsserver power cord

¹Standard Ethernet cable (BNE3xx-x) and office Ethernet cable (BNE4xx-x) can be interconnected. However, the cable attenuation (electrical characteristic) for the office Ethernet cable is greater than that of the standard Ethernet cable by a factor of four. For example, two meters (6.6 feet) of office Ethernet cable is electrically equivalent to eight meters (26.2 feet) of standard Ethernet cable.

When connecting the Commsserver to a transceiver by way of a DELNI, subtract five meters from the maximum cable length to make up for the attenuation of the DELNI.

3.4 PREINSTALLATION CHECKS

Prior to installing the Commserver, use the following checklists to make sure that site preparation is complete.

Hardware

Verify the following:

- Ethernet interface device (Etherjack junction box, DELNI, DESTA, DEMPR, or Ethernet transceiver) is installed, and the required Ethernet cabling is in place, tested, and tagged.
- Cables of appropriate length are available for connecting the Commserver to the Ethernet interface device.
- One console terminal (asynchronous, DEC 423, or EIA-232-D compatible) is available for hardware testing and system verification.

Software

Verify the following:

- The person installing the software has installed or is ready to install the Commserver software on the load host.
- VMS 5.4 or greater is installed.
- DECnet Phase IV is installed and running on the load host.

Chapter 4

INSTALLATION

This chapter describes how to install, power up, and verify the operation of the DEC Commserver 100 and the DEC Commserver 150.

NOTE

Installation and service of the Commserver hardware must be performed by trained service personnel.

Before proceeding with the installation procedures, it is recommended that you read Chapters 1, 2, and 3. These chapters provide a functional overview of the Commserver and information on shipping contents and installation site verification. Information on controls, indicators, and connectors is contained in Appendix A.

NOTE

Unless otherwise noted, the installation procedures apply to both the DEC Commserver 100 and the DEC Commserver 150.

CAUTION

To avoid damage to the Commserver, do not plug in the Commserver power cord until instructed to do so.

4.1 INSTALLATION OVERVIEW

The Commserver installation consists of installing the Commserver hardware and software, and verifying the Commserver installation. This manual describes the hardware installation only. Procedures for installing the software on a load host and for verifying the Commserver installation are in the *DEC Commserver For VMS Installation Manual*.

The customer is required to provide one terminal (asynchronous, DEC 423 or EIA-232-D compatible) for use in the hardware installation and verification procedures only. The terminal connects to the Commserver local console port and should be located near the Commserver.

It is recommended that the hardware installation be performed prior to software installation. The hardware and software must both be installed to verify the Commserver operation.

4.2 INSTALLING THE COMMSERVER HARDWARE

After verifying the installation site, install the Commserver hardware by performing the procedures in the sequence listed below.

NOTE

For a rackmount installation, perform the appropriate procedure described in Appendix C, and then continue with the following procedures.

- Configuring Commserver for Standard or ThinWire LAN ((Section 4.2.1)
- Connecting the Console Terminal (Section 4.2.2)
- Testing the Commserver Hardware (Section 4.2.3)
- Connecting to the Ethernet Network (Section 4.2.4)
- Installing the Front Cover (DEC Commserver 150, Office Model Only) (Section 4.2.5)

4.2.1 Configuring Commserver for Standard or ThinWire Ethernet LAN

Set the Ethernet Selector switch for either a standard or ThinWire Ethernet connection. Later, when power is turned on the Commserver, the Standard LED or the ThinWire LED on the I/O panel lights to indicate which connector is selected. Figure 4–1 shows the switch set for a connection to the ThinWire Ethernet connector.

Figure 4-1: Ethernet Selector

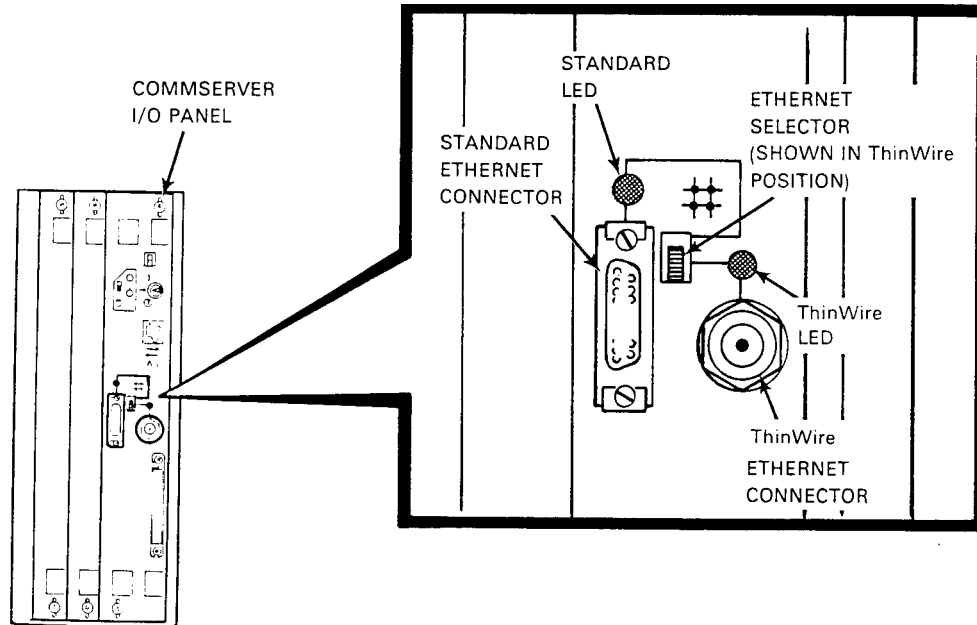

CS-8111

4.2.2 Connecting the Console Terminal

The console terminal used for testing must be EIA-232-D or DEC 423 compatible.

To connect the console terminal to the console port, refer to Figure 4–2 (Figure 4–2 shows the connection to a DEC Commserver 150) and proceed as follows:

1. Locate the console cable shipped with the Commserver and connect it to the console port on the Commserver I/O panel.
2. Connect the other end of the console cable to the communications port of the console terminal. If necessary, use the H8571-A passive adapter shipped with the Commserver. The adapter is required to interface between the DEC 423 console cable and an EIA-232-D console terminal.
3. Power on the console terminal.
4. Configure the terminal communication parameters to match the console port default parameters as follows:
 - Character Size: 8
 - Parity: None
 - Baud Rate: 9600

Figure 4-2: Connecting a Console Terminal

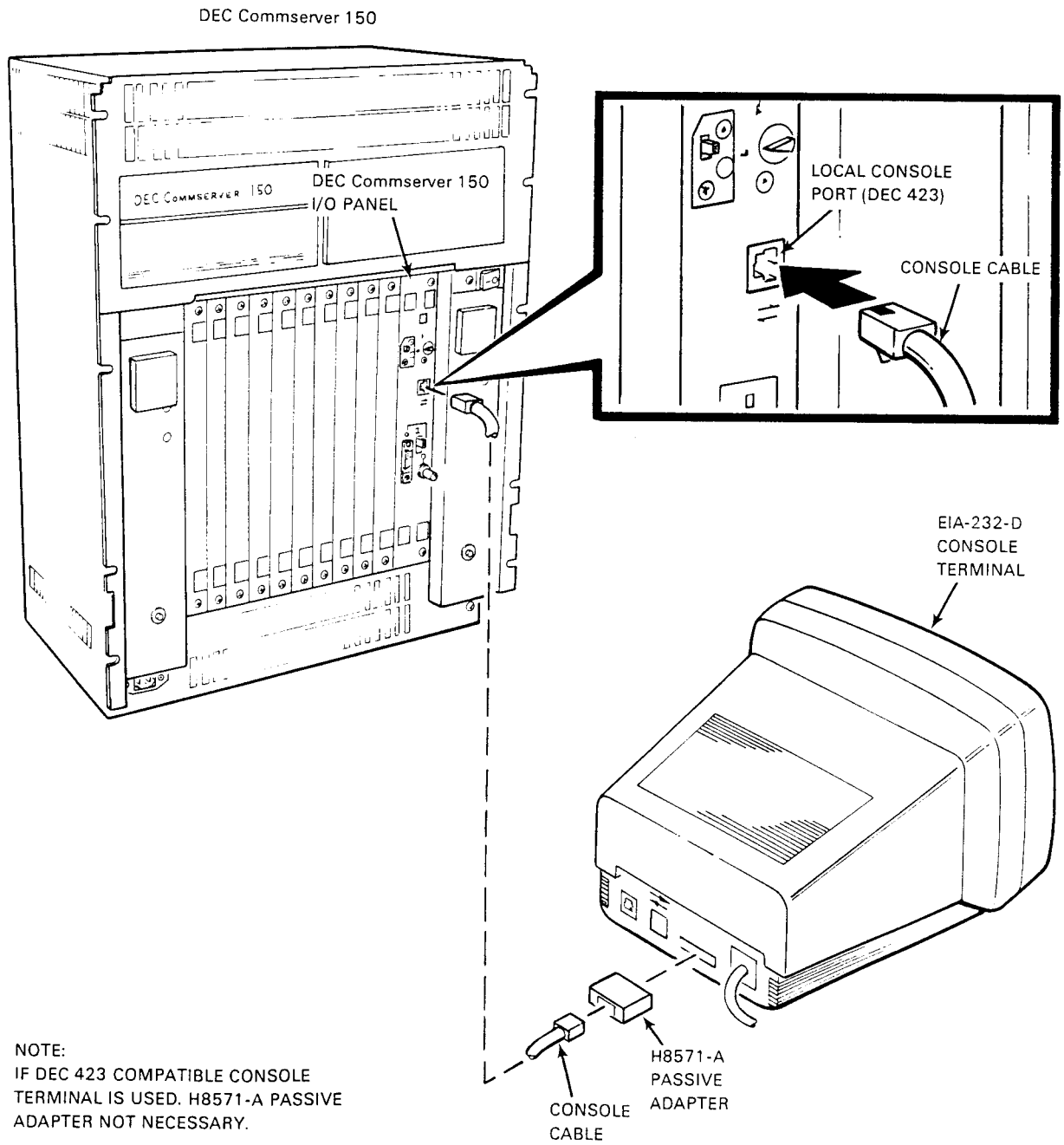

CS-8115

4.2.3 Testing the Commserver Hardware

This section provides the following procedures to test the Commserver hardware:

- Connecting ac Power to the Commserver
- Testing the Hardware

4.2.3.1 Connecting AC Power to the Commserver

If the DEC Commserver 100 is being installed, proceed to Section 4.2.3.1.1. For the DEC Commserver 150, proceed to Section 4.2.3.1.2.

4.2.3.1.1 Connecting Power to the DEC Commserver 100

If installing a DEC Commserver 100, plug the appropriate end of the power cord into the DEC Commserver 100 power receptacle only (see Figure 4-3).

NOTE

Because the DEC Commserver 100 does not have a power on/off switch, do not connect the power cord to the electrical outlet at this time.

Proceed to Section 4.2.3.2.

Figure 4-3: Connecting Power to the DEC Commserver 100

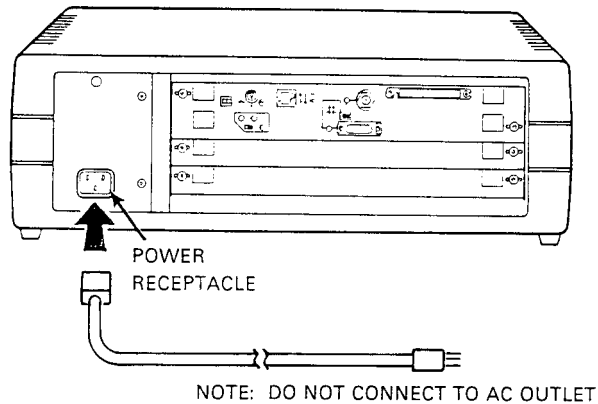

CS-8109

4.2.3.1.2 Connecting Power to the DEC Commserver 150

To connect power to the DEC Commserver 150, proceed as follows:

1. Locate the yellow voltage label covering the DEC Commserver 150 power receptacle on the front panel. (See Figure 4-4 for the location of the power receptacle. The label is not shown in the figure.)
2. Note the operating range indicated by the arrow on the label. This is the factory-set operating range of the Commserver.
3. Peel off the yellow voltage label from the Commserver to expose the power receptacle.
4. Make sure the power on/off switch is pushed to the off (O) position (see Figure 4-4).
5. Plug the appropriate end of the power cord into the Commserver power receptacle.

CAUTION

Before performing the next step, ensure that the electrical outlet provides the same voltage as indicated on the power label.

6. Plug the other end of the power cord into the electrical outlet.

Proceed to Section 4.2.3.2.

Figure 4-4: Connecting Power to the DEC Commserver 150

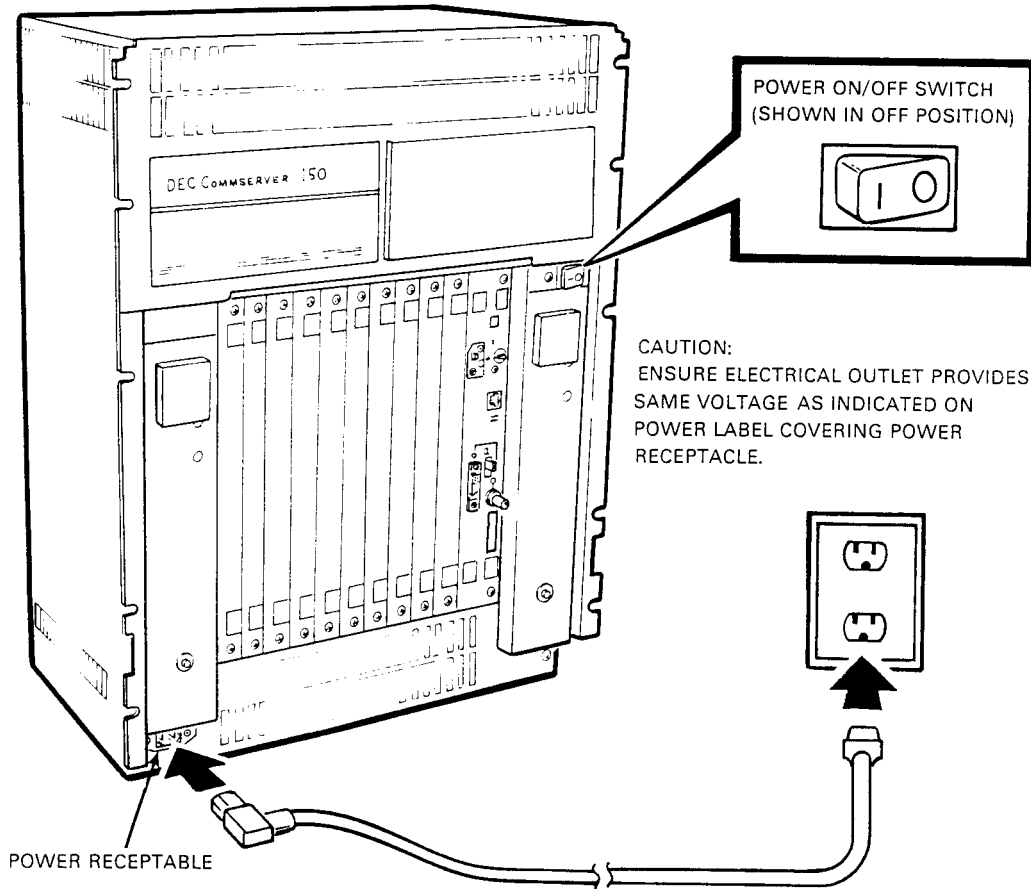

CS-8114

4.2.3.2 Testing the Hardware

This section describes how to use a local console terminal to verify that the Commserver hardware is operating properly, and the I/O panel is configured correctly for an Ethernet connection:

1. Power on the Commserver as follows:

CAUTION

Before performing step a., ensure that the DEC Commserver 150 is connected to the proper voltage source: 120 volts for 120 volt versions, or 240 volts for 240 volt version.

- a. If testing a DEC Commserver 150, push the power on/off switch to the on position (I). If the wrong I/O panel Ethernet LED lights, immediately set the power on/off switch to off (O). Go back to Section 4.2.1 and set the I/O panel Ethernet selector correctly, and then repeat this step.
 - b. If testing a DEC Commserver 100, plug the power cord into the ac electrical outlet. The power supply automatically switches to 120 or 240 Vac operation, depending on the ac source voltage. If the wrong I/O panel Ethernet LED lights, immediately unplug the power cord from the ac source. Go back to Section 4.2.1 and set the I/O panel Ethernet selector correctly, and then repeat this step.
2. Note the following events:
 - The DC OK LED(s) light. (See Figure 4–5 and Figure 4–6 for DC OK LED location.)
 - The console terminal displays the results of the self-test. Typical output is shown in Figure 4–7.
 - The LED display shows the testing sequence during power up.

Figure 4-5: Initial Power-Up of the DEC Commserver 100

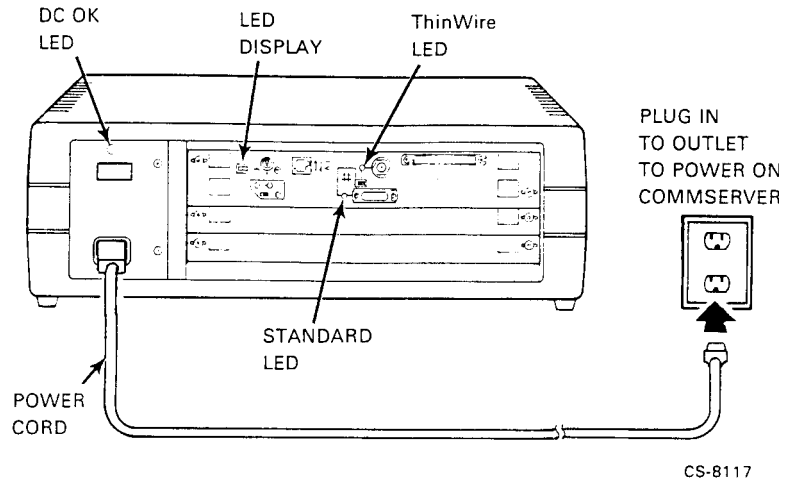
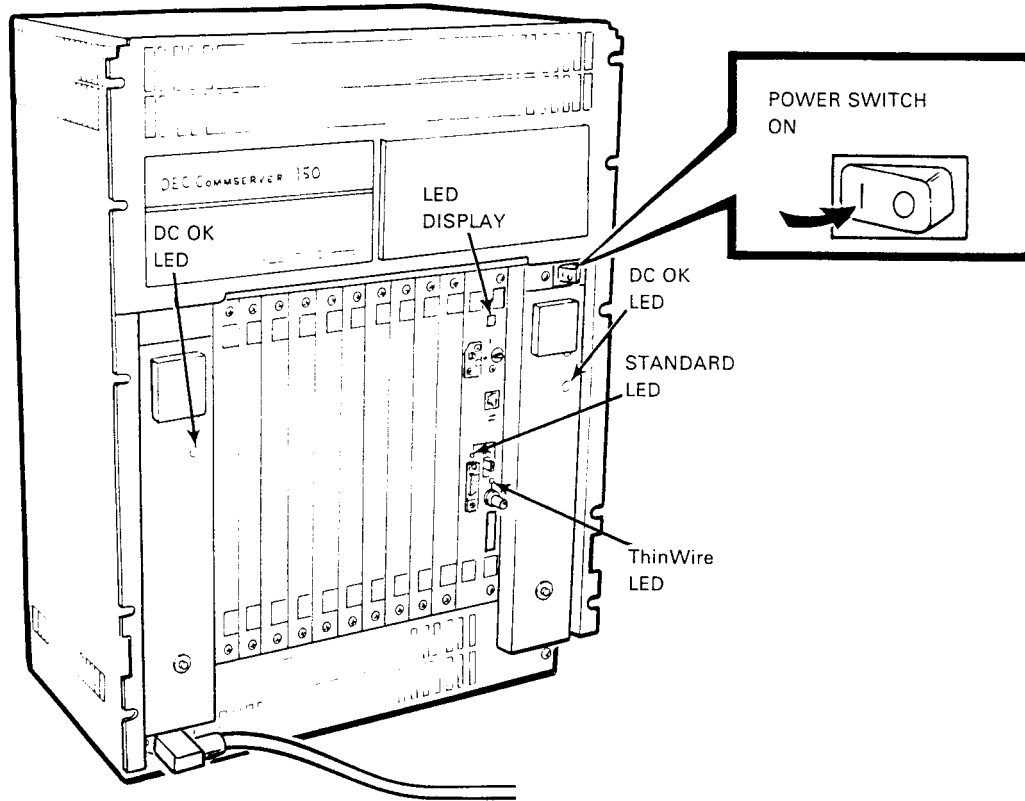

Figure 4-6: Initial Power-Up of the DEC Commserver 150



CS-8118

Figure 4-7: Typical Commserver Power-Up Self-Test Display

```
KA640-B V5.3, VMB 2.7
Performing Normal System Tests
41..40..39..38..37..36..35..34..33..32..31..30..29..28..27..26..
25..24..23..22..21..20..19..18..17..16..15..14..13..12..11..10..
09..08..07..06..05..04..03..
Tests Completed
>>>
```

3. If an error is detected during the power-up self test, proceed to Chapter 5 for troubleshooting information. If the self-test is completed without error, verify the address printed on the I/O panel by entering SHOW ETHERNET at the console and note the Ethernet address displayed as shown in Example 4-1. (In this example, 08-00-2B-16-02-E3 is the address.)

Example 4-1: Command to Display Ethernet Address

```
>>>SHOW ETHERNET
Ethernet Adapter
-ESAO (08-00-2B-16-02-E3)
>>>
```

NOTE

If the address displayed does not match the address on the I/O panel and the one recorded on the identification card, change the address on the I/O panel and identification card, accordingly.

4. After verifying that the Commserver is operating properly, disconnect the power (DEC Commserver 100) or set the power switch to off (O) (DEC Commserver 150). Then proceed to the appropriate appendix for information concerning the installation and verification of communications modules.
5. Disconnect the console cable and console terminal.

NOTE

After installing and verifying the operation of the communications modules, continue with Section 4.2.4 to complete the Commserver hardware installation. However, if you do not intend to install the communications modules at this time, you may proceed to Section 4.2.4.

4.2.4 Connecting to the Ethernet Network

The Ethernet controller supports connections to standard and ThinWire Ethernet LANs. If in Section 4.2.1 you configured the Commsserver for the standard Ethernet LAN connection, proceed to Section 4.2.4.1. If you configured the Commsserver for a ThinWire Ethernet LAN connection, proceed to Section 4.2.4.2.

4.2.4.1 Connecting to a Standard Ethernet LAN

Perform the following steps to connect the standard Ethernet cable to the Commsserver standard Ethernet connector:

1. If necessary, unlock the slide switch on the Commsserver standard Ethernet connector.
2. Connect the standard Ethernet cable to the Commsserver standard Ethernet connector. Figure 4–8 shows the connection being made on a DEC Commsserver 100. (The cable should have a right-angle end connector.)
3. Lock the slide latch on the Ethernet connector. Tug gently on the cable to make sure it is securely connected.

Figure 4–8: Connecting to the Standard Ethernet LAN

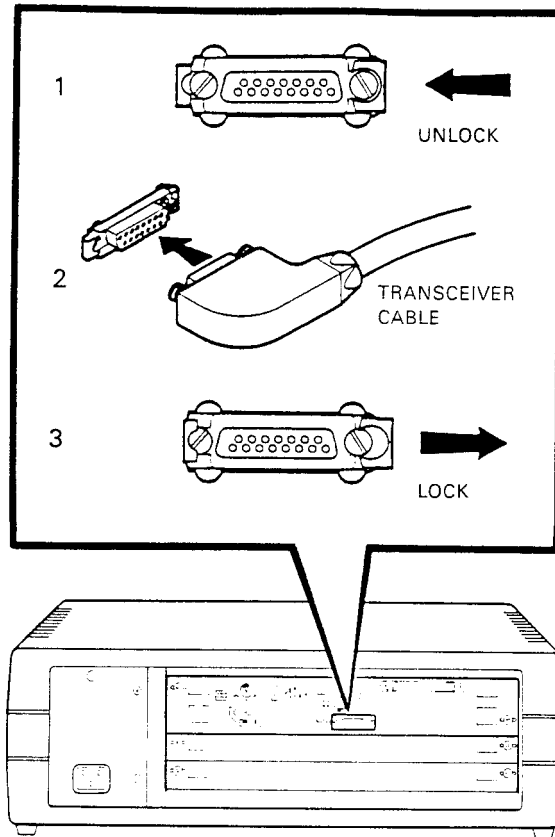

CS-8110

4.2.4.2 Connecting to a ThinWire Ethernet LAN

Perform the following steps to connect the ThinWire Ethernet cable to the Commserver ThinWire Ethernet connector:

1. Locate the T connector shipped with the Commserver.
2. Hold the T connector so that the T portion is in a horizontal position (for the DEC Commserver 100) or vertical position (for the DEC Commserver 150). Then, install the connector onto the ThinWire Ethernet (BNC) connector on the Commserver I/O panel. The example in Figure 4–9, insert A, shows the connection being made on a DEC Commserver 100.
3. If the Commserver is the last device in the Ethernet network, be sure to install a terminator on the T connector as shown in Figure 4–9, insert B.
4. If the Commserver is not the last device in the network, you must install the strain-relief clamp as described in Section 4.2.4.3.

Figure 4-9: Connecting to the ThinWire Ethernet LAN

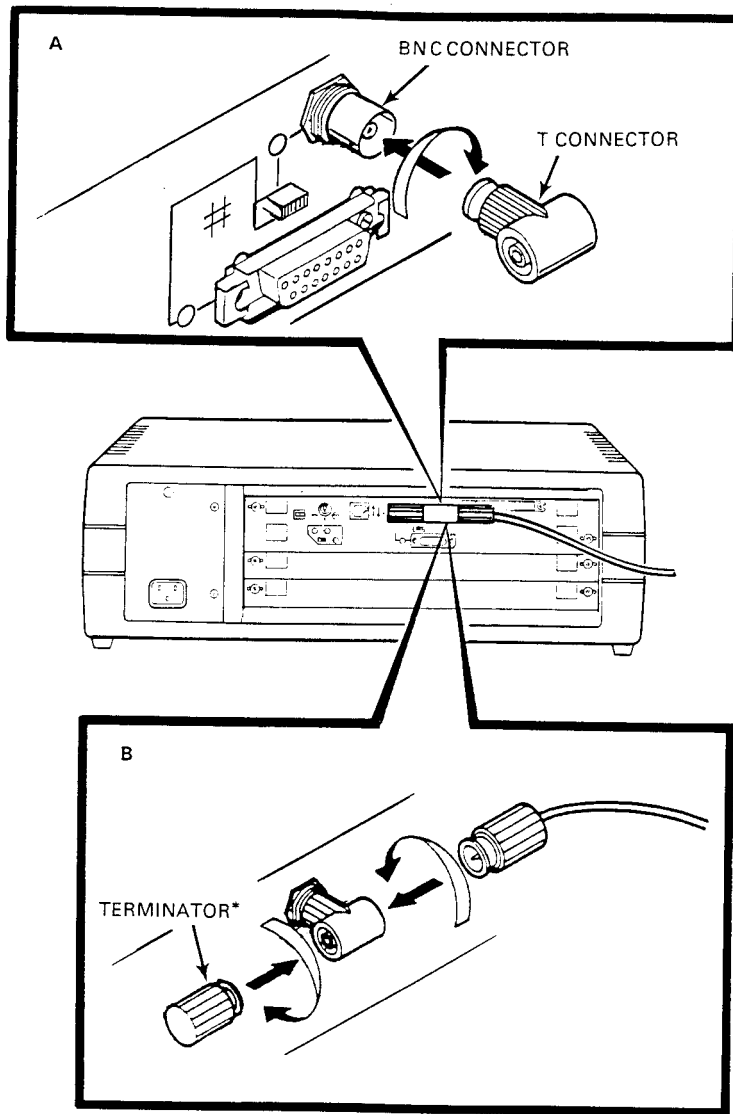

*IF THIS IS THE LAST DEVICE

CS-8112

4.2.4.3 Installing the ThinWire Ethernet Strain-Relief Clamp

If the Commsserver is not the last device in the ThinWire Ethernet network, you must install the strain-relief clamp and adhere to the minimum bend radius as described in the following instructions:

1. Locate the ThinWire strain-relief cable clamp shipped with the Commsserver, and keep it handy for use in the following steps.
2. Connect the cable going to the next device, as shown in Figure 4–10, insert A.

CAUTION

To prevent damaging the cable in the next step, make sure the cable is not crimped and has a loop radius greater than 4 centimeters (1.6 inches).

3. Make a loop in the cable going to the next device, as shown in Figure 4–10, insert B.
4. Use the ThinWire strain-relief cable clamp to secure the cable, as shown in Figure 4–10.

Figure 4-10: Installing the ThinWire Strain-Relief Clamp

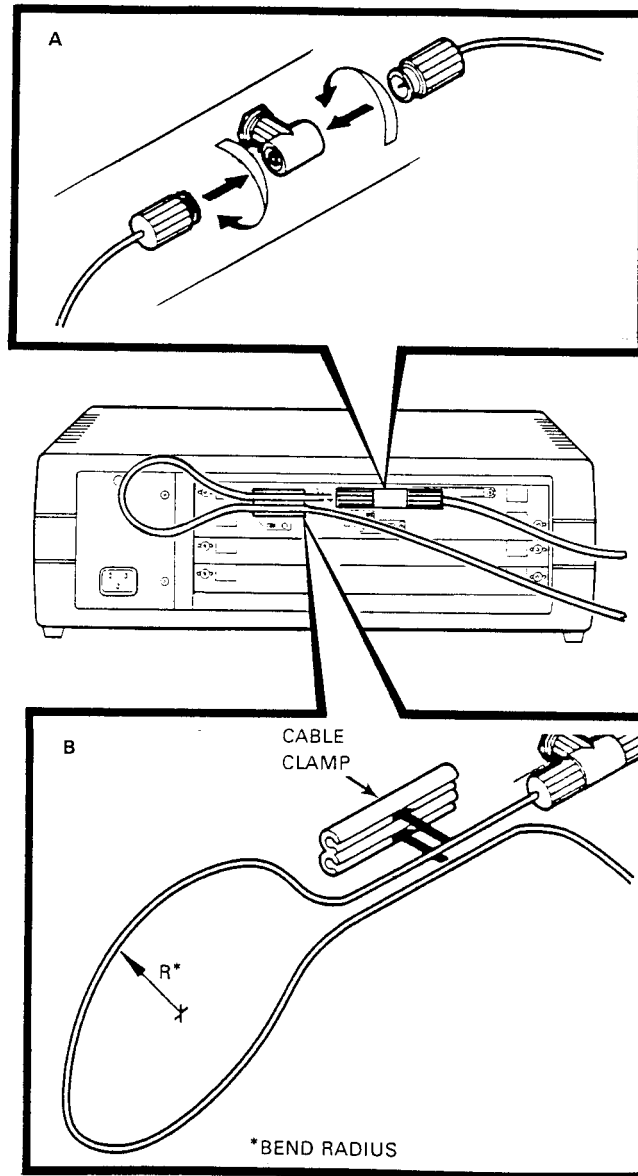

CS-8113

4.2.5 Installing the Front Cover (DEC Commserver 150, Office Model Only)

After the office model is completely cabled and the Commserver operation verified, install the front cover as follows:

1. As shown in Figure 4-11, insert the antistatic key (supplied with the shipment) in the keyhole on the front cover, and turn the key clockwise until it stops.

Figure 4-11: Unlocking the Front Cover (Office Model)

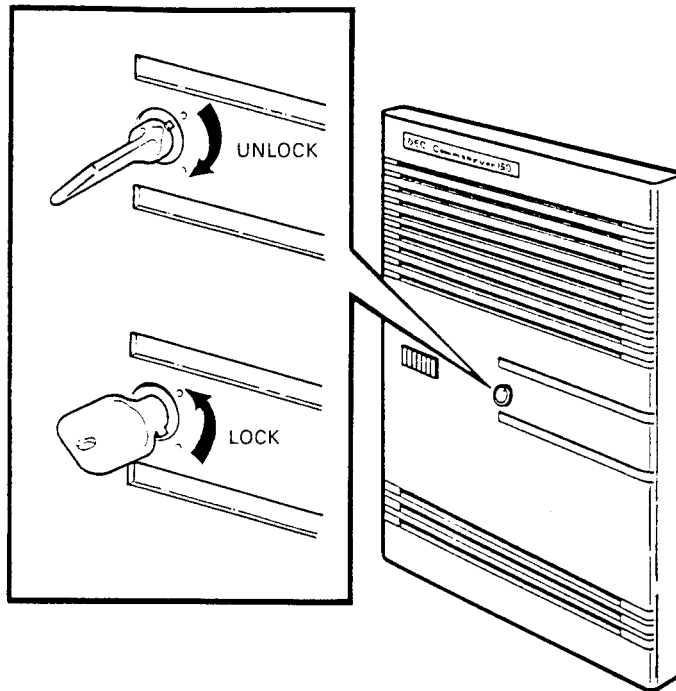

CS-8116

2. As shown in Figure 4-12, position the front cover so that the brackets slide into the notches in the Commserver frame.
3. Lock the cover in place by turning the key counterclockwise until it stops.

Figure 4-12: Installing the Front Cover (Office Model)

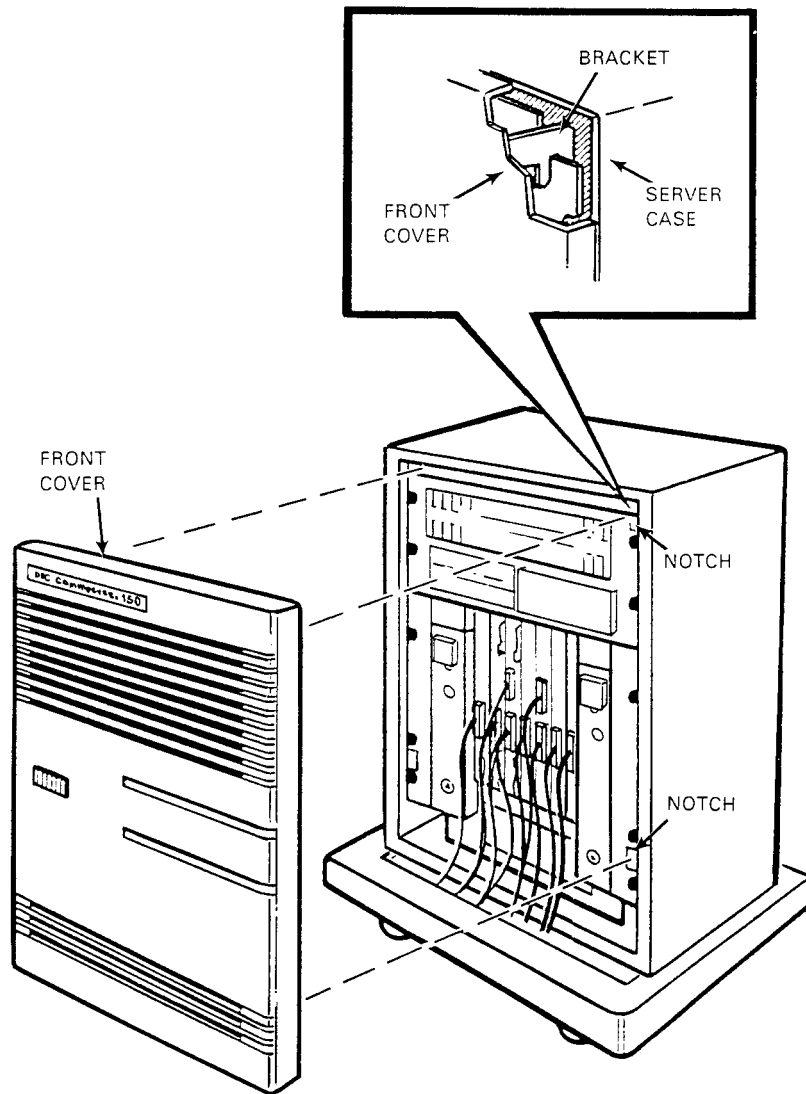

CS-8119

4.3 Preparing the Commserver for Downloading of Software

Complete the Commserver hardware installation as described in Sections 4.1 and 4.2. Set the Break Enable/Disable Switch to disable the break function and to prepare the Commserver for the downloading of the Commserver software, and for normal system operation. For the location and description of the Break Enable/Disable switch, refer to Appendix A.

Chapter 5

WHAT TO DO IF YOU HAVE PROBLEMS

This chapter provides help in isolating and correcting problems found during the power-on self-test. Table 5–1 lists troubleshooting power-on problems and includes the cause and corrective action. If the recommended corrective action does not remedy the problem, call Digital Customer Service.

NOTE

For problems related to communications modules, refer to the applicable documentation for troubleshooting information.

Table 5–1: Troubleshooting Power-on Problems

Problem	Possible Cause	Corrective Action
No DC OK lit or no response when powered on.	Commsserver power cord not plugged into power outlet.	If DEC Commsserver 100, plug power cord into outlet. If DEC Commsserver 150, set the on/off switch to O. Plug in the power cord to an outlet with the same ac voltage rating as the Commsserver. Set the on/off switch to I.
	No power at the wall outlet.	Use a different wall outlet, or check the circuit breaker controlling power to the wall outlet.
	System circuit breaker(s) is tripped. DEC Commsserver 150 only.	Set the on/off switch to O. Reset the circuit breaker(s) by pushing it in. Set the on/off switch to I. If either circuit breaker trips again, call your Digital Customer Service.

Table 5-1 (Cont.): Troubleshooting Power-on Problems

Problem	Possible Cause	Corrective Action
The Commserver has power (power connected to DEC Commserver 100 or on/off switch is set to 1 on DEC Commserver 150), but no display appears on the console terminal.	Power cable is incorrectly installed.	If DEC Commserver 100, check if power cord plug is fully seated in the Commserver power receptacle. If DEC Commserver 150, set the on/off switch to O. Check that the cable is fully seated in the Commserver power receptacle. Set the on/off switch to 1.
	Console terminal is turned off.	Turn on the console terminal.
	Console terminal is off-line.	Put the terminal on-line. Refer to the terminal documentation for instructions.
	Console terminal cable is not installed correctly.	Make sure the cable is installed properly at both ends.
	Baud rate setting of the system and the terminal do not match.	Set the terminal baud rate to match the system. The normal operating system setting is 9600.
	Power-up Mode switch on I/O panel is set to T.	Set the switch to Run (indicated by an arrow).
The self-tests halted before completion and an error message displayed on the console terminal.	Terminal is defective.	Connect a new terminal.
	The system detected an error while testing the CPU.	Copy the number of the error message and call Digital Customer Service.

Appendix A





CONTROLS, INDICATORS, AND CONNECTORS

This appendix identifies and describes the controls, indicators, and connectors on the DEC Commserver 100 and the DEC Commserver 150.

A.1 DEC Commserver 100

The controls, indicators, and connectors are located on the rear of the DEC Commserver 100. For the description and location of the controls, indicators and connectors, refer to Table A-1 and Figure A-1.



Table A-1: DEC Commserver 100 Controls, Indicators, and Connectors

Symbol	Item	Function
None	AC Power Connector	Receives the ac power cord to provide power to the DEC Commserver 100.
<p>Caution</p> <p>The DEC Commserver 100 does not have a power switch. Connection of the ac power cord serves as the power switch.</p> <p>When power is connected, the DEC Commserver 100 automatically adjusts to operate on the ac voltage supplied (120 Vac or 240 Vac) and then initiates its power-on self-test.</p>		
None	DC OK LED	When lit (green), indicates the power supply is functioning properly. When off, a problem exists with the Commserver or power is not connected properly.
None	LED Display	Shows the testing sequence during power-up.
	Break Enable/Disable Switch	Two-position switch that enables or disables the break feature as follows:
		† Break Enable position: Enables the Break key on the console terminal to stop the processor and transfer control to the console program.
		‡ Break Disable position: Disables the break feature and enables the server to be downline loaded with DEC Commserver software.
	Power-Up Mode Switch	Three-position rotary switch that determines how the system responds at power-up:
		† Run Mode position: This is the normal operation setting.
		Language Inquiry Mode position: Causes the system to display a language selection menu at power-up (assuming the console terminal supports character sets for multiple languages).

†Indicates a factory set switch setting.

‡Must be set in this position prior to software installation.

Table A-1 (Cont.): DEC Commserver 100 Controls, Indicators, and Connectors

Symbol	Item	Function
		Loopback Test Mode position: Causes the system to run loopback tests at power-up. This setting is for Digital Customer Service use only.
	Local Console Port	This is a modular DEC 423 connector used for Commserver installation and diagnostic purposes only.
	Ethernet Selector Switch	When set towards the symbol, the Standard Ethernet Connector is set to accept an Ethernet connection. † When set away from the symbol, the ThinWire Ethernet Connector is set to accept an Ethernet connection.
None	ThinWire LED	When lit, indicates that the Ethernet Selector Switch is set for a ThinWire Ethernet connection.
None	ThinWire Ethernet Connector	BNC connector that supports connection to a ThinWire Ethernet local area network using a ThinWire cable.
None	Standard Ethernet Connector	Female D connector that supports connection to a Standard Ethernet local area network using a transceiver cable.
None	Standard LED	When lit, indicates that the Ethernet Selector Switch is set for a standard Ethernet connection.

†Indicates a factory set switch setting.

Figure A-1: DEC Commserver 100 Controls, Indicators, and Connectors

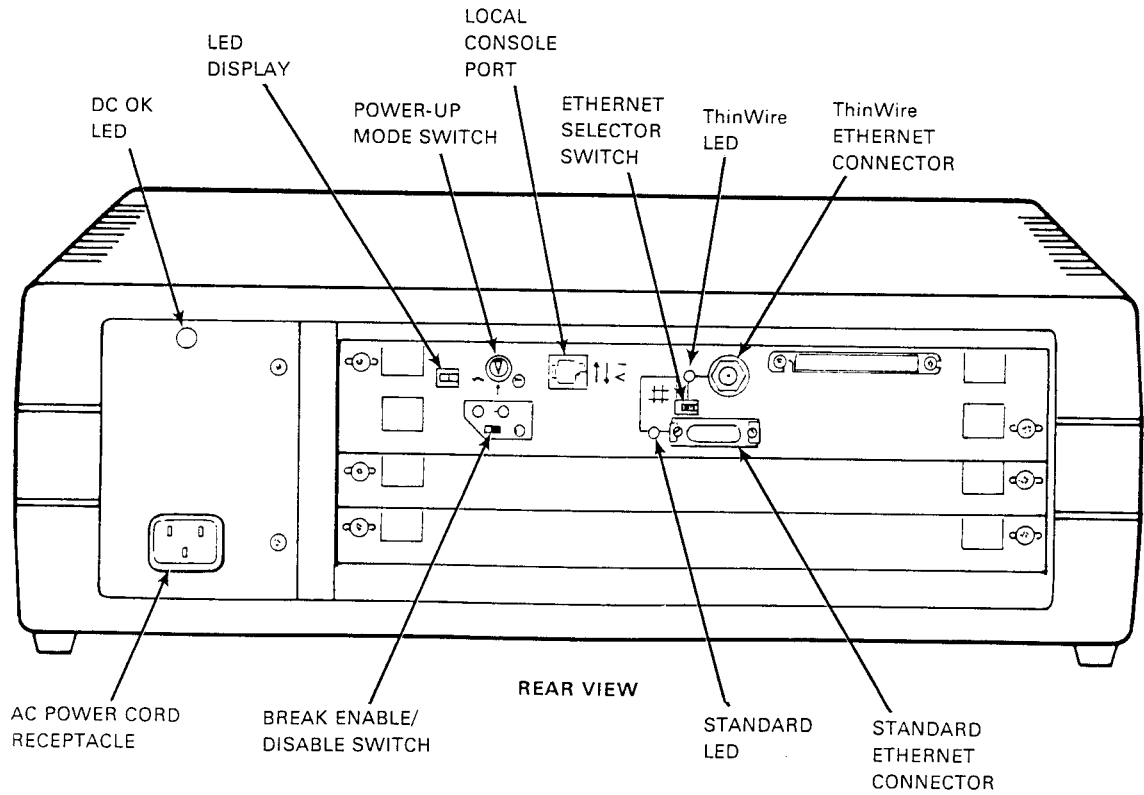

CS-8124



A.2 DEC Commserver 150

The DEC Commserver 150 indicators, controls, and connectors used during operation are located on the front of the Commserver.

On the rackmount model of the DEC Commserver 150, the controls, indicators, and connectors are immediately accessible because the front panel is exposed. On the office model, the controls, indicators, and connectors are behind the front cover of the cabinet.

For the description and location of the DEC Commserver 150 controls, indicators, and connectors, refer to Table A-2 and Figure A-2.

Table A-2: DEC Commserver 150 Controls, Indicators, and Connectors

Symbol	Item	Function
None	AC Power Connector	Receives the ac power cord to provide power to the DEC Commserver 150.
None	Circuit Breaker	Provides overcurrent protection for the Commserver. If the power supply draws too much current, a button in the center of the circuit breaker pops out. To reset the breaker, press the button back in.
	Power Reset Switch	Resets the dc output (operating) voltages of the power supply. The left power supply (facing unit) provides operating voltages for the six leftmost slots. The right power supply provides operating voltages for the remaining slots, including CPU and I/O panel.
None	DC OK LEDs	When lit (green), indicates that the power supply is functioning properly. If either LED is off, a problem exists with the Commserver.
None	LED Display	Shows the testing sequence during power-up.
I/O	Power On/Off Switch	When set to I, power to the Commserver is on. When set to O, power is off. When power is switched on, the Commserver initiates its power-on self-test.
	Break Enable/Disable Switch	Two-position switch that enables or disables the break feature as follows:
		† Break Enable position: Enables the Break key on the console terminal to stop the processor and transfer control to the console program.
		‡ Break Disable position: Disables the break feature and enables the server to be downline loaded with DEC Commserver software.

†Indicates a factory set switch setting.

‡Must be set in this position prior to software installation.

Table A-2 (Cont.): DEC Commserver 150 Controls, Indicators, and Connectors

Symbol	Item	Function
	Power-Up Mode Switch	Three-position rotary switch that determines how the system responds at power-up:
→		† Run Mode position: This is the normal operation setting.
⌚		Language Inquiry Mode position: Causes the system to display a language selection menu at power-up (assuming the console terminal supports character sets for multiple languages).
Ⓣ		Loop Back Test Mode position: Causes the system to run loopback tests at power-up. This setting is for Digital Customer Service use only.
↔	Local Console Port	This is a modular DEC 423 connector used for Commserver installation and diagnostic purposes only.
⚡	Ethernet Selector Switch	When set towards the symbol, the Standard Ethernet Connector is set to accept an Ethernet connection. † When set away from the symbol, the ThinWire Ethernet Connector is set to accept an Ethernet connection.
None	ThinWire LED	When lit, indicates that the Ethernet Selector Switch is set for a ThinWire Ethernet connection.
None	ThinWire Ethernet Connector	BNC connector that supports connection to a ThinWire Ethernet local area network using a ThinWire cable.
None	Standard Ethernet Connector	Female D connector that supports connection to a Standard Ethernet local area network using a transceiver cable.
None	Standard LED	When lit, indicates that the Ethernet Selector Switch is set for a standard Ethernet connection.

†Indicates a factory set switch setting.

Figure A-2: DEC Commserver 150 Controls, Indicators, and Connectors

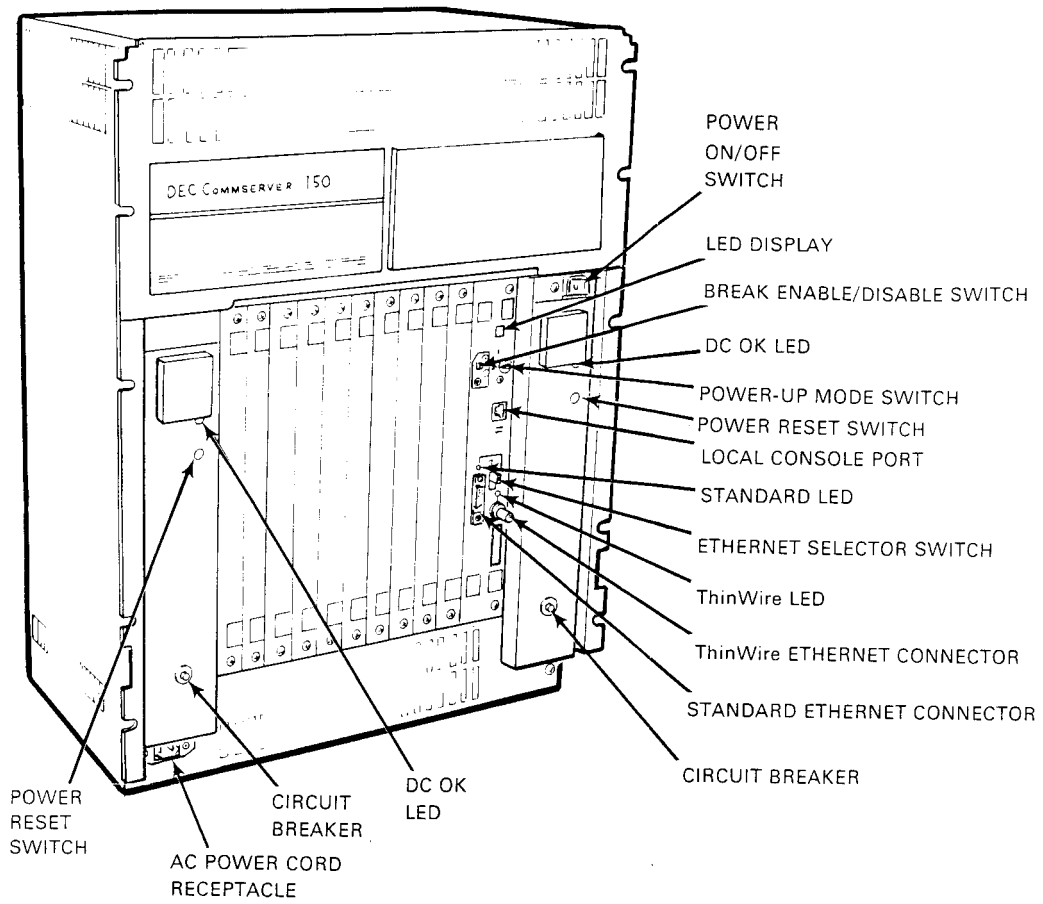

CS-8101

Appendix B

SPECIFICATIONS

Table B-1 and Table B-2 list the specifications for the DEC Commserver 100 and DEC Commserver 150, respectively.

Table B-1: DEC Commserver 100 Specifications

Item	Specification
I/O PORTS	
Ethernet	Ethernet/IEEE 802.3 serial port. Switch selectable for Standard or ThinWire Ethernet connection. Interfaces with Digital Network Interface (NI) ports.
Available slots for optional modules	2
PHYSICAL	
With Plastic Covers	
Height	16.2 cm (6.4 in)
Width	49.4 cm (19.4 in)
Depth	31.3 cm (12.3 in)
Weight	9.5 kg (21 lbs) (without optional modules) 11.4 kg (25 lbs) maximum (with optional modules)
Without Plastic Covers	
Height	13.3 cm (5.3 in)
Width	46.0 cm (18.28 in)
Depth	29.8 cm (11.7 in)
Weight	7.7 kg (17 lbs) (without optional modules) 9.5 kg (21 lbs) maximum (with optional modules)
ENVIRONMENTAL	
Temperature	
Operating	10°C (50°F) to 40°C (104°F)
Nonoperating	-40°C (-40°F) to 66°C (151°F)
Temperature Change/Hour	11°C (20°F) maximum

Table B-1 (Cont.): DEC Commserver 100 Specifications

Item	Specification
RELATIVE HUMIDITY	
Operating (noncondensing)	10% to 90%
Nonoperating (noncondensing)	10% to 90%
Wet-bulb temperature (operating)	28°C (90°F) maximum
Dew point (operating)	2°C (36°F) maximum
Air flow	40.0 CFM minimum
ALTITUDE	
Operating	2.4 km (8,000 ft) maximum
Nonoperating	4.9 km (16,000 ft)
AC POWER	
Automatic Power Sensing for 120-Volt or 240-Volt operation	
120-Volt Operation	100 to 120 Vac, 47 to 63 Hz, 1.2 A maximum
240-Volt Operation	220 to 240 Vac, 47 to 63 Hz, 0.6 A maximum
Power Phase	Single
Power Consumption	120 W maximum
HEAT DISSIPATION	410 Btu/hr

Table B-2: DEC Commserver 150 Specifications

Item	Specification
I/O PORTS	
Ethernet	Ethernet/IEEE 802.3 serial port. Switch selectable for Standard or ThinWire Ethernet connection. Interfaces with Digital Network Interface (NI) ports.
Available slots for optional modules	10
PHYSICAL	
Office Model	
Height	69.0 cm (27.0 in)
Width	53.0 cm (21.0 in)
Depth	45.0 cm (17.8 in)
Weight	39.5 kg (85 lbs) (without optional modules) 45 kg (100 lbs) maximum (with optional modules)
Rack-Mount Model	
Height	66.0 cm (26.25 in) (without optional modules)
Height	70.4 cm (28.0 in) (with one or more optional modules)
Width	46.0 cm (18.28 in)
Depth	45.0 cm (17.8 in)
Weight	27.3 kg (60 lbs) (without optional modules) 34 kg (75 lbs) maximum (with optional modules)
ENVIRONMENTAL	
Temperature	
Operating	10°C (50°F) to 40°C (104°F)
Nonoperating	-40°C (-40°F) to 66°C (151°F)
Temperature Change/Hour	11°C (20°F) maximum

Table B-2 (Cont.): DEC Commserver 150 Specifications

Item	Specification
RELATIVE HUMIDITY	
Operating (noncondensing)	10% to 90%
Nonoperating (noncondensing)	10% to 90%
Wet-bulb temperature (operating)	28°C (90°F), maximum
Dew point (operating)	2°C (36°F), maximum
Air flow	40.0 CFM, minimum
ALTITUDE	
Operating	2.4 km (8,000 ft) maximum
Nonoperating	4.9 km (16,000 ft)
AC POWER	
120-Vac Version	100 to 120 Vac, 47 to 63 Hz, 10.2 A maximum
240-Vac Version	220 to 240 Vac, 47 to 63 Hz, 4.7 A maximum
Power Phase	Single
Power Consumption	670 W maximum
HEAT DISSIPATION	2,304 Btu/hr

Appendix C

RACKMOUNT HARDWARE INSTALLATION

The DEC Commserver 100 is shipped with the hardware necessary to mount it in a standard 19-inch RETMA rack. The DEC Commserver 150 (rackmount model) is shipped with a BA213 Rackmount Kit. Follow the instructions in that kit to rack mount the DEC Commserver 150. This appendix describes how to prepare and rack mount the DEC Commserver 100.

NOTE

Complete the appropriate rack mounting procedure and then return to Chapter 4 to complete the Commserver installation.

The following DEC Commserver 100 installation procedures consist of:

- Removing the plastic covers
- Attaching the mounting brackets
- Mounting the DEC Commserver 100 into the rack

A medium-sized Phillips screwdriver is needed to rack mount the Commserver.

C.1 REMOVING THE PLASTIC COVERS

To remove the plastic covers, see Figure C-1 and proceed as follows:

1. Place the Commserver upside down on a sturdy table or floor.
2. Remove and save the four long screws with rubber feet and four short screws from the bottom of the Commserver.
3. Remove the bottom cover and the two side covers, then lift the unit out of the top cover and place it right side up on the sturdy surface.
4. Store the eight screws and the plastic covers for possible future use or reconfiguration for a table top installation.

Figure C-1: Removing Plastic Covers

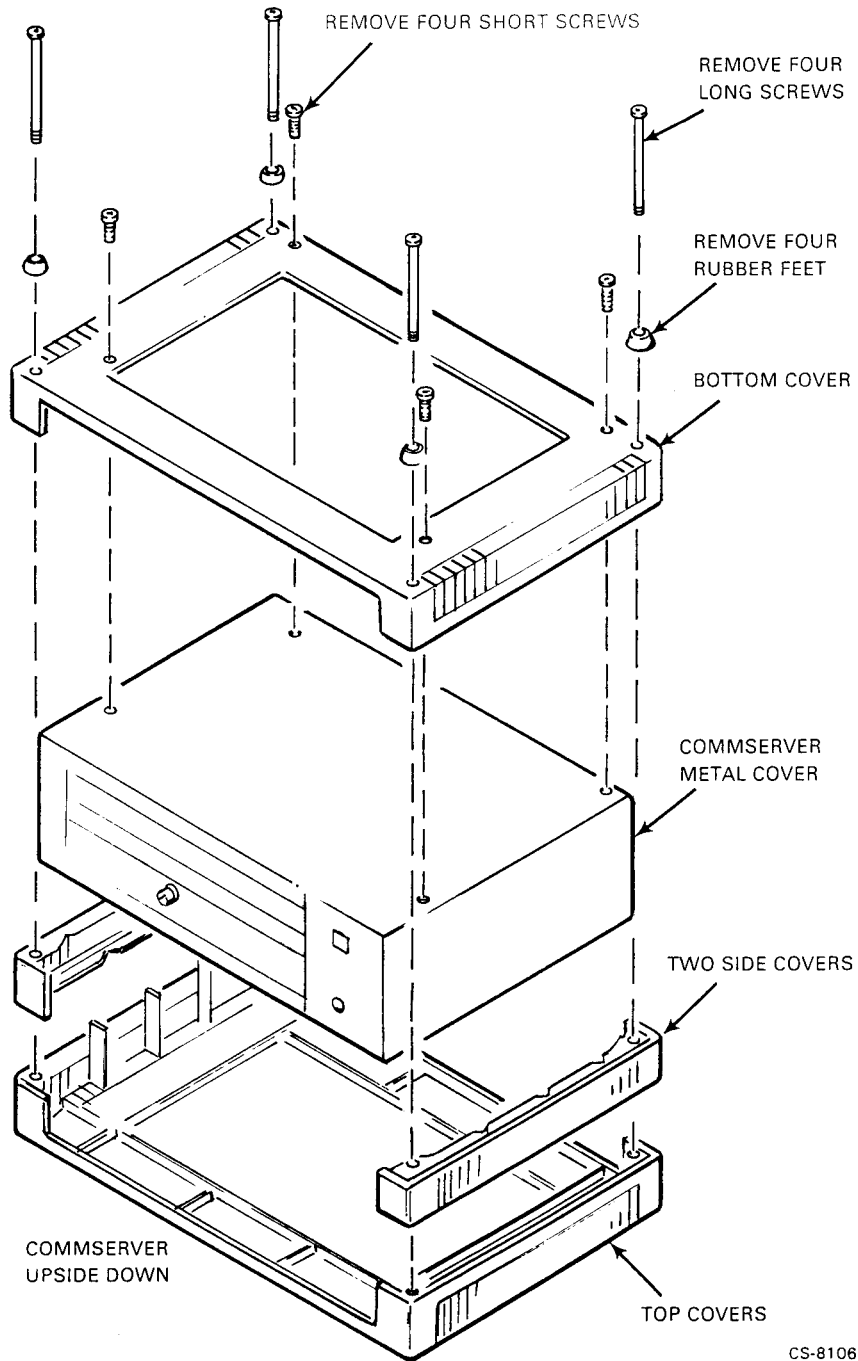

C-2 RACKMOUNT HARDWARE INSTALLATION

C.2 ATTACHING THE MOUNTING BRACKETS

Attach the mounting brackets as follows:

1. Remove the two screws from the side of the metal cover as shown in Figure C-2.

Figure C-2: Removing Screws from Metal Cover

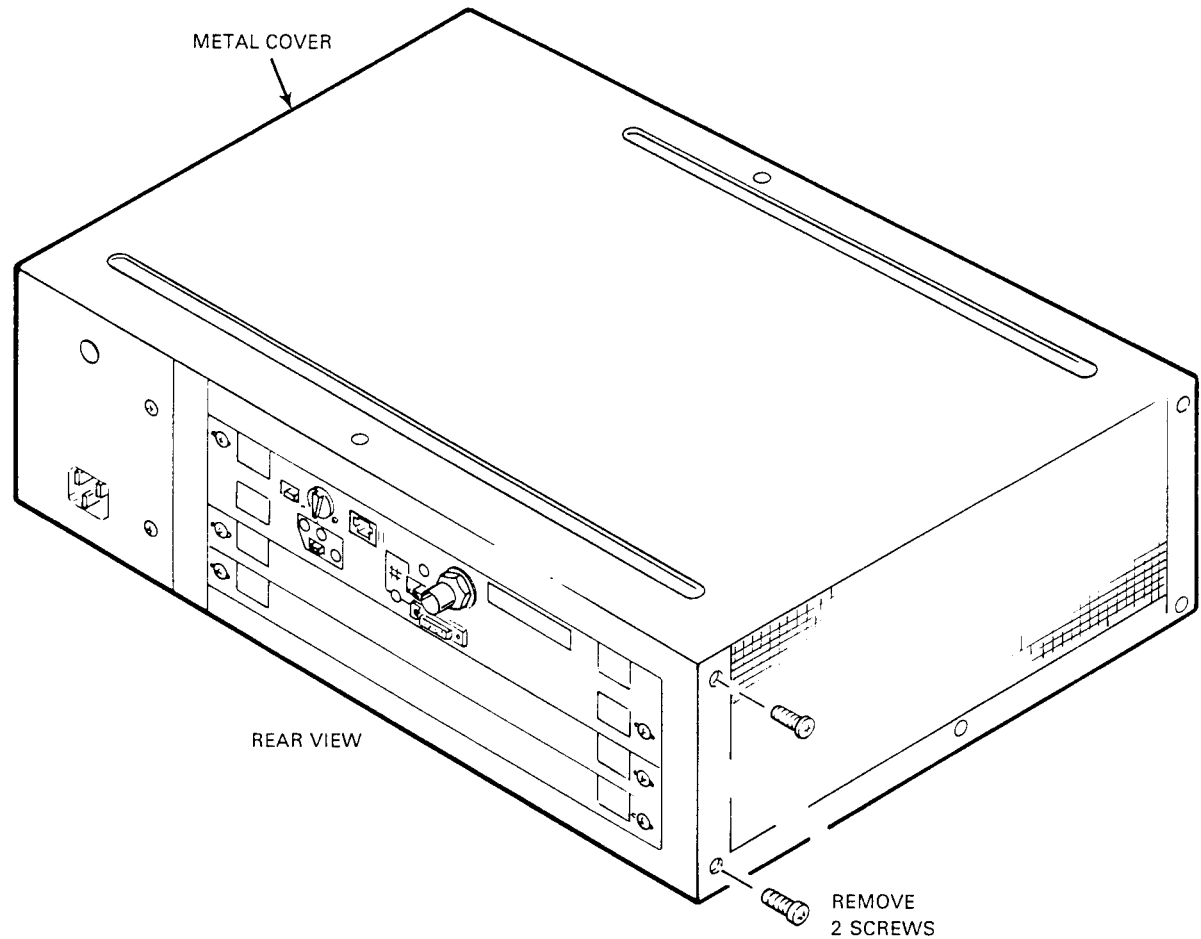

CS-8102

2. Locate the two mounting brackets and the six 8-32 Phillips-head screws with lockwashers shipped with the Commserver. You will need only four of these screws.

3. Use the four screws to fasten the brackets to the sides of the metal cover as shown in Figure C-3.

Figure C-3: Attaching the Mounting Brackets

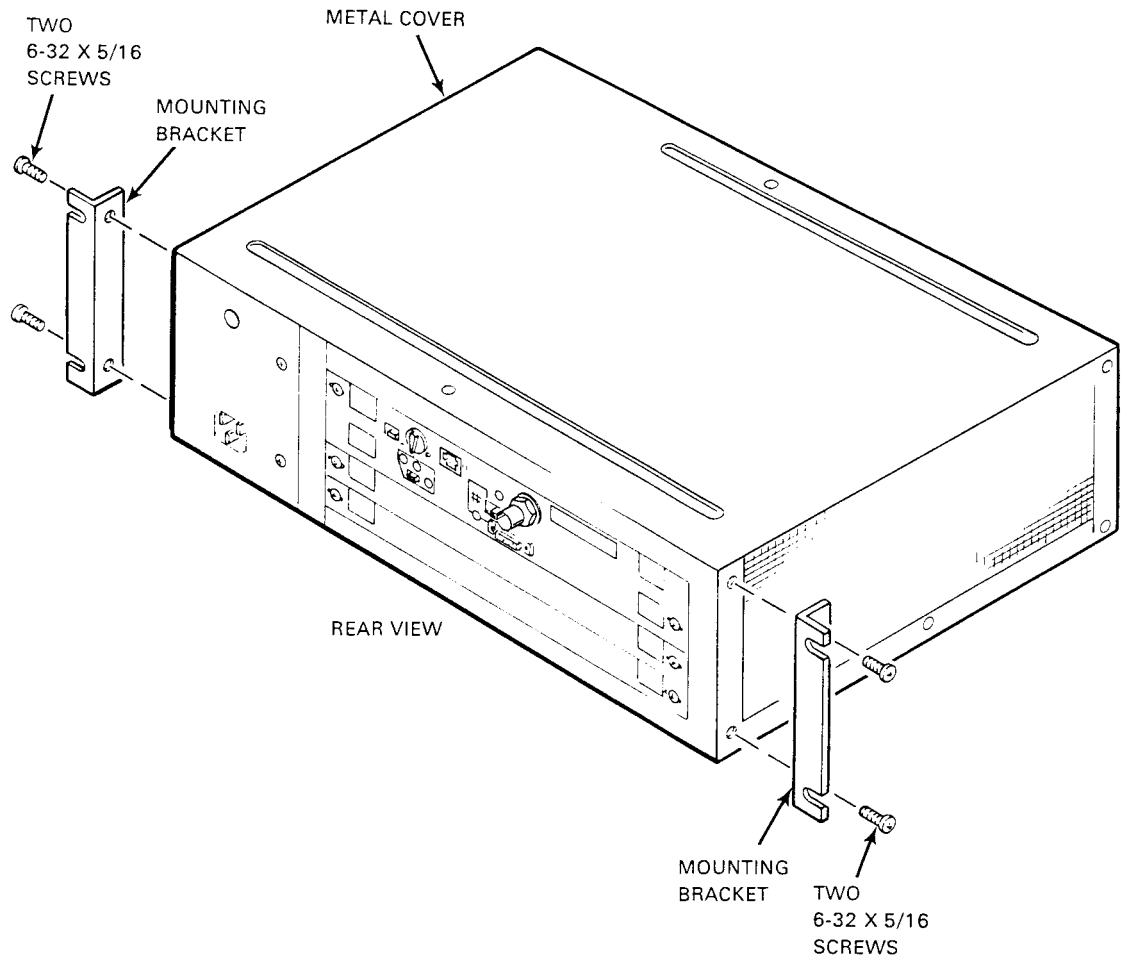

CS-8103

C.3 MOUNTING THE DEC Commserver 100 INTO THE RACK

To mount the Commserver into the rack, refer to Figure C-4 and proceed as follows:

1. Locate the four 10-32, truss head screws and the four retainer nuts shipped with the Commserver.
2. Determine where you will mount the Commserver in the rack. Be sure to leave 9 cm (3.5 in) of space between the Commserver and the next unit below it to allow the routing of cables to the back of the rack.
3. Slide on the retainer nuts (see Figure C-4 insert) at the appropriate locations on the rails of the rack so that the clips align with the top and bottom holes in the brackets.
4. Attach the Commserver to the rack with the four 10-32 screws, inserting one screw through the top and bottom hole of each bracket.
5. Go to Chapter 4 and continue the installation.

Figure C-4: Mounting the DEC Commserver 100 into the Rack

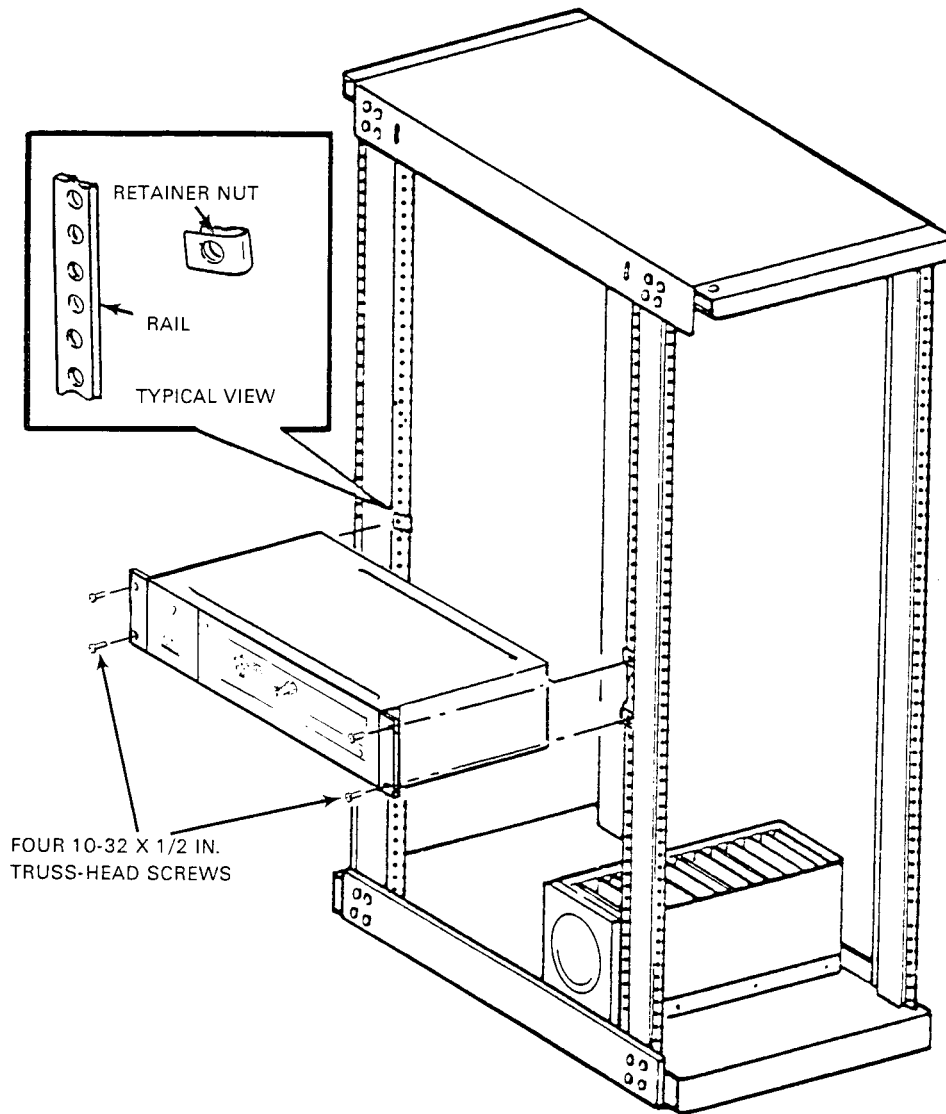

CS-8107

Appendix D

ICP1622T SERIES MODULE INSTALLATION AND VERIFICATION

This appendix provides a brief introduction to the Simpack ICP1622T series modules and associated distribution kits. Also provided is additional information on installation and other items not covered in the installation instructions shipped with the modules and kits.

D.1 INTRODUCTION

The Simpack ICP1622T Intelligent Communications Processor serves to interface multiple, low-speed serial data communications lines to the DEC Commserver 100 and DEC Commserver 150. The ICP1622T has four independently programmable serial communications interfaces that include both data and modem control signals.

A communications distribution kit is used with the ICP1622T. Depending on the kit, one or more of the following components may be included:

- Distribution panel
- ICP1622-to-distribution panel interconnection cable(s)
- Loopback cable

The panel is usually mounted in a location more accessible than the ICP1622T and provides interface connectors consistent with the electrical interface standard (such as EIA-232, EIA-449, V.35) required for the application.

The Simpack EXC1612T augments the capabilities of the ICP1622T front-end communications processor by providing 12 additional communications ports. Each communications port supports EIA-232 signals. The EXC1612T is used in conjunction with the ICP1622T and cannot be used as a single entity. The pair of boards (ICP1622T and EXC1612T) is used to interface both multiple and low-speed serial data communications lines. Two of the EXC1612T ports can be configured for Direct Memory Access (DMA).

The DEC Commserver 100 has two slots for optional modules and can support up to two single ICP1622T modules or an ICP1622T and EXC1612T pair. The DEC Commserver 150 has 10 slots for optional boards. The DEC Commserver 150 can support any mix of module pairs and single ICP1622Ts with a total maximum limit of eight ICP1622Ts.

D.2 SIMPACT MODULES AND DISTRIBUTION HARDWARE

The information in Table D–1 provides a list of the Simpact modules and associated kits. A cross reference between the Digital Option order number and the Simpact part number for each module and kit is also provided.

CAUTION

Distribution kits only work with specified modules. Intermixing may damage module or external devices. For example, distribution kit CK-DSPAX-BA is only used with module DSPAX-BA.

Table D–1: Module/Kit Order Number Cross Reference Table

DEC Option Order No.	Simpact Part No.	Description
DSPAX-AA	ICP1622T-AA	Intelligent Communications Processor, which supports 4 ports of EIA-232, EIA-449 or V.35
CK-DSPAX-AA	DBK1-01	EIA-232, 4-Port Distribution Kit
CK-DSPAX-AB	DBK2-01	EIA-449, 2-Port Distribution Kit
CK-DSPAX-AC	DBK5-01	V.35, 2-Port Distribution Kit
DSPAX-BA	ICP1622TA-BA	Intelligent Communications Processor, which supports 4 ports of EIA-232/V.28
CK-DSPAX-BA	DBK60-01	EIA-232/V.28, 4-Port Distribution Kit
DSPAX-CA	EXC1612TA-AD	12-Port Expansion Module for ICP1622T and ICP1622TA modules
CK-DSPAX-CA	DBK3-01	EIA-232/V.28, 4-Port Distribution Kit
H3132-AA	DBX	Mounting brackets for distribution panels

D.3 INSTALLATION

Before installing any modules, read all the installation documentation supplied with the ICP1622T and EXC1612T. The information covers the installation instructions with annotated precautions to help ensure a successful installation. The information includes instructions for the hardware installation of the modules, distribution panels, and cabling. Also covered is board configuration.

To install the modules, proceed as follows:

1. Ensure that you tested the Commserver hardware as described in Chapter 4.
2. Power down the Commserver.
3. Starting at the lowest numbered empty slot adjacent to the Commserver I/O panel, remove the blank cover panels from the needed number of slots and retain them for future use.

NOTE

If you are going to use all slots including slot I/O 10 in a DEC Commserver 150 installation, you need to remove the load module residing in that slot. Refer to Section D.5 for instructions.

4. Proceed to the installation instructions provided with the ICP1622T and EXC1612T and install the modules as described. Be sure to abide by configuration rules described in Section D.1.
5. Refer to Table D-1 and make sure the distribution kit being installed is compatible with the installed module (for example, distribution kit CK-DSPAX-AA is used with module DSPAX-AA). Then, using the installation instructions provided with the distribution kit, install the distribution panels and connect cables between the panels and the modules (see Figure D-1).

CAUTION

Do not connect external devices to the distribution panels. Connect external devices only after performing the software installation and system verification procedures.

Figure D-1: Routing Cables in the DEC Commserver 150 (Office Model)

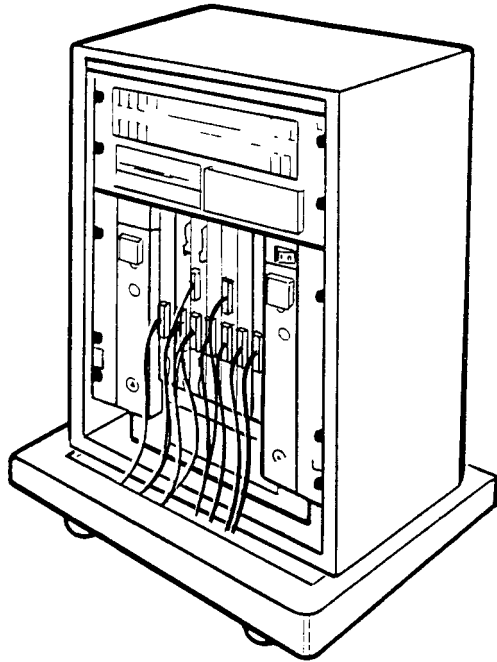

CS-8194

D.4 VERIFICATION

To verify the installation of the communication modules and distribution hardware, perform the following steps:

1. Check and label all cable connections.
2. Power up the Commserver and observe the diagnostic LEDs on the ICP1622T communication modules. During the power-up self-test sequence of the modules, the LEDs follow the self-test sequence. If the self test is completed successfully, a four-on four-off LED pattern will be displayed as shown in Figure D-2. If a communication module does not complete the self test successfully, replace that module.

Figure D-2: Indication when Self Test Is Successful

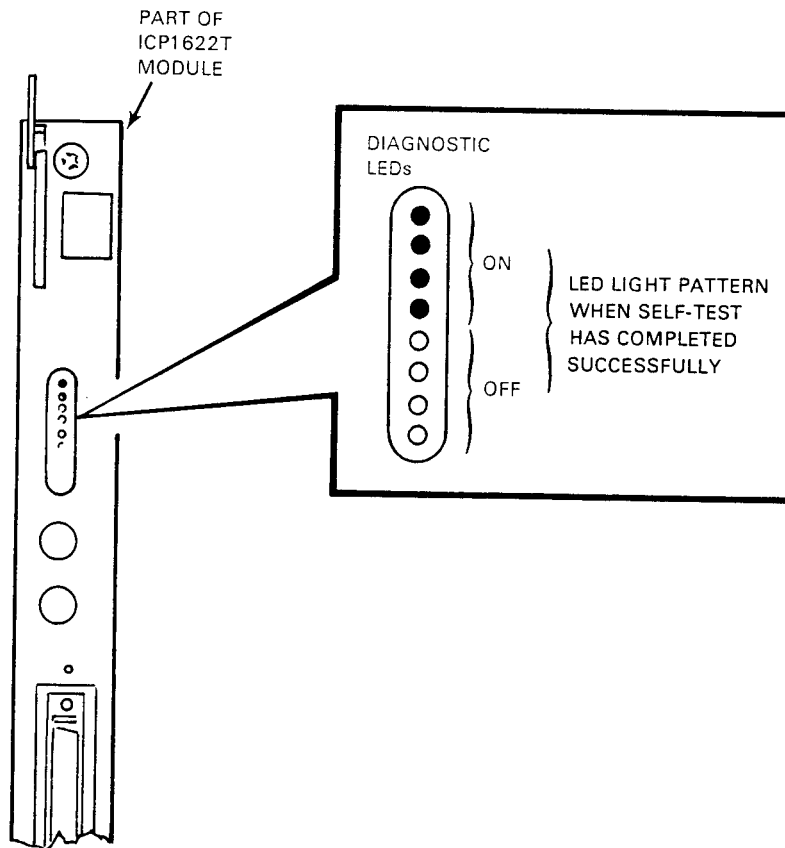

CS-8193

D.5 REMOVING A LOAD MODULE

If you are installing a communications module in slot I/O 10 of a DEC Commserver 150, remove the load module as follows:

NOTE

You can only use slot I/O 10 when slots I/O 1 through I/O 9 are occupied.

The slots are labeled I/O 1 through I/O 10 on the Commserver just above the module slot.

1. Remove the blank cover panel from slot I/O 10 by loosening the two quarter-turn captive-screws located near the top and bottom of the panel.
2. Simultaneously pull the load module upper and lower release levers outward to disengage the module from the backplane (see Figure D-3).
3. Remove the module from the Commserver by gently sliding the module outward.
4. Save the load module. The load module keeps a load on the left-side power supply when no modules are installed in slots I/O 5 through I/O 10. You will need to reinstall the module in I/O 10 if a future reconfiguration of the Commserver leaves slots I/O 5 through I/O 10 vacant.

Figure D-3: Removing the Load Module

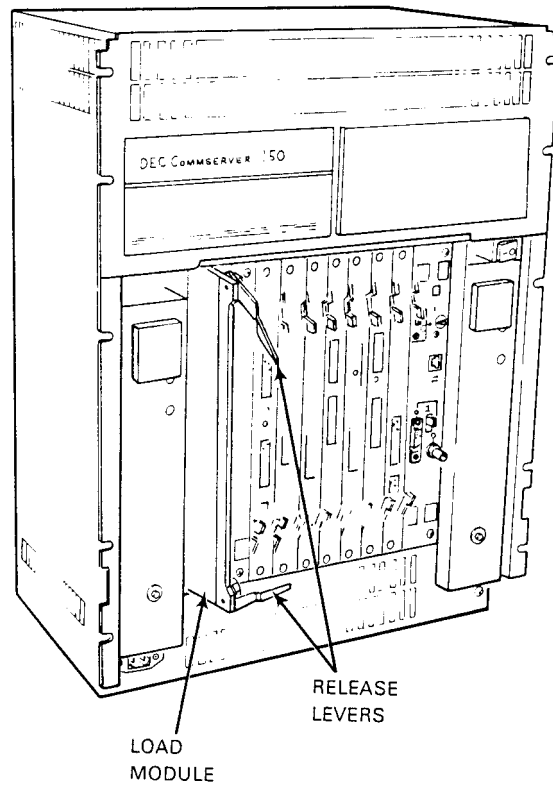

CS-8195

Appendix E

POWER CORDS/ORDER NUMBERS

Table E-1 provides a list of the power cords and related Digital order numbers for both the DEC Commserver 100 and DEC Commserver 150 units.

Table E-1: Power Cords/Order Numbers

Power Cords	DEC Commserver 100	DEC Commserver 150
Australia	BN19H-2E	BN20C-2E
Belgium, Finland, France, Holland, Norway, Spain, Sweden	BN19C-2E	BN20D-2E
Denmark	BN19K-2E	BN20H-2E
Germany	BN19C-2E	BN20D-2E
India	BN19S-2E	BN20K-2E
Israel	BN19U-2E	BN20L-2E
Italy	BN19M-2E	BN20J-2E
Japan	BN18K-1K	BN20B-2E
Switzerland	BN19E-2E	BN20F-2E
UK	BN19A-2E	BN20E-2E
US	BN09A-1K	BN20A-2E

DEC Commserver Identification Card

Hardware Installer

Please copy the serial number and the Ethernet address from the DEC Commserver hardware unit onto this card. Also include your name, the date of the installation, and the location of the hardware unit (for example, office number, building, floor). After completing this information, give this card and the software license to the system/network manager.

Serial number

--	--	--	--	--	--	--	--	--	--

Ethernet address

--	--	--	--	--	--	--	--	--	--	--	--

Location _____

Your name _____ Date ____/____/____

System/Network Manager

Please record below the DECnet node name and DECnet node address of the DEC Commserver. The person who installs the distribution software onto the load host needs this information. After completing the information, give this card to the person installing the software.

DECnet node name _____

DECnet node address _____
(Include both the area and the address within the area.)

Notes: _____

Software Installer

When you exit VMSINSTAL:

1. Give the *DEC Commserver Identification Card* to the server manager.
2. Direct the server manager to store the card in the documentation binder.