

DWLMA XMI PIU Installation Guide

Order Number EK-DWLMA-IN.001

This manual describes the installation of the XMI PIU into VAX 7000/10000 and DEC 7000/10000 AXP systems. Both system and expander cabinet installation are covered.

First Printing, February 1993

The information in this document is subject to change without notice and should not be construed as a commitment by Digital Equipment Corporation.

Digital Equipment Corporation assumes no responsibility for any errors that may appear in this document.

The software, if any, described in this document is furnished under a license and may be used or copied only in accordance with the terms of such license. No responsibility is assumed for the use or reliability of software or equipment that is not supplied by Digital Equipment Corporation or its affiliated companies.

Copyright © 1993 by Digital Equipment Corporation.

All Rights Reserved.
Printed in U.S.A.

The following are trademarks of Digital Equipment Corporation:

Alpha AXP	DECUS	VAXBI
AXP	DWMVA	VAXELN
DEC	OpenVMS	VMScluster
DECchip	ULTRIX	XMI
DEC LANcontroller	UNIBUS	The AXP logo
DECnet	VAX	

OSF/1 is a registered trademark of the Open Software Foundation, Inc.

FCC NOTICE: The equipment described in this manual generates, uses, and may emit radio frequency energy. The equipment has been type tested and found to comply with the limits for a Class A computing device pursuant to Subpart J of Part 15 of FCC Rules, which are designed to provide reasonable protection against such radio frequency interference when operated in a commercial environment. Operation of this equipment in a residential area may cause interference, in which case the user at his own expense may be required to take measures to correct the interference.

Contents

Preface	v
----------------------	---

Chapter 1 Introduction

1.1	XMI PIU Placement and Rules	1-2
1.2	XMI PIU Kit Contents	1-4

Chapter 2 Installation of the XMI PIU

2.1	Preparing the Cabinet	2-2
2.2	Installing the Card Cage Assembly	2-4
2.3	Installing the 4 to 1 Cable	2-6
2.4	Installing the IOP Hose Cable	2-8
2.5	Installing the DWLMA	2-10

Chapter 3 Verification

3.1	Restore Power and Check Self-Test Results	3-2
-----	---	-----

Appendix A Moving Hinges on the Bulkhead Door

A.1	Moving the Hinges of the Bulkhead Door	A-2
-----	--	-----

Examples

3-1	Sample Self-Test Display	3-2
-----	--------------------------------	-----

Figures

1- 1	System and Expander Cabinet XMI PIU Placement	1- 2
1- 2	XMI Card Cage Assembly	1- 4
2- 1	Airflow Plate	2- 2
2- 2	Installing the XMI PIU	2- 4
2- 3	Placement of the 4 to 1 Cable	2- 6
2- 4	I/O Bulkhead Panel Designations	2- 7
2- 5	IOP Cable Installation and Routing	2- 8
2- 6	Installing the DWLMA	2- 10
3- 1	IOP Port Diagram	3- 3
A- 1	Bulkhead Doors on the XMI PIU Rear Cable Enclosure	A- 2

Tables

1	DEC 7000/VAX 7000 Documentation	vii
2	Related Documents	ix
1- 1	DWLMA XMI PIU Kit Contents	1- 5

Preface

Intended Audience

This manual is written for Digital service engineers installing XMI plug-in units in systems with an LSB as the system bus.

Document Structure

This manual uses a structured documentation design. Topics are organized into small sections for efficient on-line and printed reference. Each topic begins with an abstract. You can quickly gain a comprehensive overview by reading only the abstracts. Next is an illustration or example, which also provides quick reference. Last in the structure are descriptive text and syntax definitions.

This manual has three chapters and one appendix, as follows:

- **Chapter 1, Introduction**, describes the XMI PIU, its placement in the system, and XMI configuration rules.
- **Chapter 2, Installation of the XMI PIU**, describes the installation procedure.
- **Chapter 3, Verification**, describes the acceptance procedures.
- **Appendix A, Moving Hinges on the Bulkhead Door**, describes how to move the hinges on the I/O bulkhead door.

Conventions Used in This Document

Terminology. Unless specified otherwise, the use of "system" refers to either a DEC 7000 AXP or VAX 7000 system. The DEC 7000 AXP systems use the Alpha AXP architecture. References in text use DEC 7000 to refer to DEC 7000 AXP systems.

Book titles. In text, if a book is cited without a product name, that book is part of the hardware documentation. It is listed in Table 1 along with its order number.

Icons. The icons shown below are used in illustrations for designating part placement in the system described. A shaded area in the icon shows the location of the component or part being discussed.

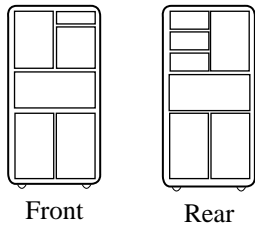

Documentation Titles

Table 1 lists the books in the DEC 7000 and VAX 7000 documentation set. Table 2 lists other documents that you may find useful.

Table 1 DEC 7000/VAX 7000 Documentation

Title	Order Number
Installation Kit	EK-7000B-DK
<i>Site Preparation Guide</i>	EK-7000B-SP
<i>Installation Guide</i>	EK-700EB-IN
Hardware User Information Kit	EK-7001B-DK
<i>Operations Manual</i>	EK-7000B-OP
<i>Basic Troubleshooting</i>	EK-7000B-TS
Service Information Kit—VAX 7000	EK-7002A-DK
<i>Platform Service Manual</i>	EK-7000A-SV
<i>System Service Manual</i>	EK-7002B-SV
<i>Pocket Service Guide</i>	EK-7000A-PG
<i>Advanced Troubleshooting</i>	EK-7001A-TS
Service Information Kit—DEC 7000	EK-7002B-DK
<i>Platform Service Manual</i>	EK-7000A-SV
<i>System Service Manual</i>	EK-7002B-SV
<i>Pocket Service Guide</i>	EK-7700A-PG
<i>Advanced Troubleshooting</i>	EK-7701A-TS

Table 1 DEC 7000/VAX 7000 Documentation (Continued)

Title	Order Number
Reference Manuals	
<i>Console Reference Manual</i>	EK-70C0B-TM
<i>KA7AA CPU Technical Manual</i>	EK-KA7AA-TM
<i>KN7AA CPU Technical Manual</i>	EK-KN7AA-TM
<i>MS7AA Memory Technical Manual</i>	EK-MS7AA-TM
<i>I/O System Technical Manual</i>	EK-70I0A-TM
<i>Platform Technical Manual</i>	EK-7000A-TM
Upgrade Manuals	
<i>KA7AA CPU Installation Card</i>	EK-KA7AA-IN
<i>KN7AA CPU Installation Guide</i>	EK-KN7AA-IN
<i>MS7AA Memory Installation Card</i>	EK-MS7AA-IN
<i>KZMSA Adapter Installation Guide</i>	EK-KXMSX-IN
<i>DWLMA XMI PIU Installation Guide</i>	EK-DWLMA-IN
<i>DWMBB VAXBI PIU Installation Guide</i>	EK-DWMBB-IN
<i>H7237 Battery PIU Installation Guide</i>	EK-H7237-IN
<i>H7263 Power Regulator Installation Card</i>	EK-H7263-IN
<i>BA654 DSSI Disk PIU Installation Guide</i>	EK-BA654-IN
<i>BA655 SCSI Disk and Tape PIU Installation Guide</i>	EK-BA655-IN
<i>Removable Media Installation Guide</i>	EK-TFRRD-IN

Table 2 Related Documents

Title	Order Number
General Site Preparation	
<i>Site Environmental Preparation Guide</i>	EK-CSEPG-MA
System I/O Options	
<i>BA350 Modular Storage Shelf Subsystem Configuration Guide</i>	EK-BA350-CG
<i>BA350 Modular Storage Shelf Subsystem User's Guide</i>	EK-BA350-UG
<i>BA350-LA Modular Storage Shelf User's Guide</i>	EK-350LA-UG
<i>CIXCD Interface User Guide</i>	EK-CIXCD-UG
<i>DEC FDDIcontroller 400 Installation / Problem Solving</i>	EK-DEMFA-IP
<i>DEC LANcontroller 400 Installation Guide</i>	EK-DEMNA-IN
<i>DEC LANcontroller 400 Technical Manual</i>	EK-DEMNA-TM
<i>DSSI VAXcluster Installation and Troubleshooting Manual</i>	EK-410AA-MG
<i>InfoServer 150 Installation and Owner's Guide</i>	EK-INFSV-OM
<i>KDM70 Controller User Guide</i>	EK-KDM70-UG
<i>KFMSA Module Installation and User Manual</i>	EK-KFMSA-IM
<i>KFMSA Module Service Guide</i>	EK-KFMSA-SV
<i>RRD42 Disc Drive Owner's Manual</i>	EK-RRD42-OM
<i>RF Series Integrated Storage Element User Guide</i>	EK-RF72D-UG
<i>Tx85 Series Cartridge Tape Subsystem Owner's Manual</i>	EK-OTF85-OM
<i>TLZ06 Cassette Tape Drive Owner's Manual</i>	EK-TLZ06-OM

Table 2 Related Documents (Continued)

Title	Order Number
Operating System Manuals	
<i>Alpha Architecture Reference Manual</i>	EY-L520E-DP
<i>DEC OSF/1 Guide to System Administration</i>	AA-PJU7A-TE
<i>DECnet for OpenVMS Network Management Utilities</i>	AA-PQYAA-TK
<i>Guide to Installing DEC OSF/1</i>	AA-PS2DA-TE
<i>OpenVMS Alpha Version 1.0 Upgrade and Installation Manual</i>	AA-PQYSA-TE
<i>VMS Upgrade and Installation Supplement: VAX 7000-600 and VAX 10000-600 Series</i>	AA-PRAHA-TE
<i>VMS Network Control Program Manual</i>	AA-LA50A-TE
VMScusters and Networking	
<i>HSC Installation Manual</i>	EK-HSCMN-IN
<i>SC008 Star Coupler User's Guide</i>	EK-SC008-UG
<i>VAX Volume Shadowing Manual</i>	AA-PBTVA-TE
Peripherals	
<i>Installing and Using the VT420 Video Terminal</i>	EK-VT420-UG
<i>LA75 Companion Printer Installation and User Guide</i>	EK-LA75X-UG

Chapter 1

Introduction

The XMI plug-in unit (PIU) is an I/O subsystem bus that can be installed in an LSB system cabinet or an LSB expander cabinet. This chapter describes the placement of the XMI PIU in both the system and expander cabinets and the contents of the two kits. It also lists XMI configuration rules. Sections include:

- XMI PIU Placement and Rules
- XMI PIU Kit Contents

1.1 XMI PIU Placement and Rules

The XMI PIU takes up two of four quadrants of space in the bottom of either a system or expander cabinet. The XMI card cage is installed in either the right or left front quadrant and extends into the rear quadrant.

Figure 1-1 System and Expander Cabinet XMI PIU Placement

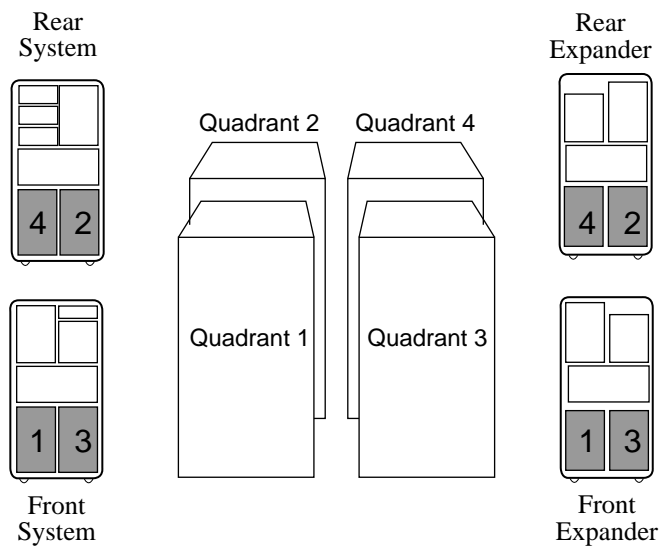

BXB-0044M-93

Figure 1- 1 shows the quadrant designation for system and expander cabinets. XMI PIUs are installed in the bottom of either cabinet with the card cages and power regulators installed in the front. The XMI PIU requires two quadrants of space: quadrants 1 and 2 if the card cage is installed on the left, and quadrants 3 and 4 if it is installed on the right when you face either cabinet. From the front of either cabinet the XMI PIU must be to the left of a VAXBI PIU if one is installed.

The following rules apply:

1. XMI PIUs in cabinets
 - a. XMI PIUs are placed in the bottom of cabinets.
 - b. A maximum of two XMI PIUs can be placed in a cabinet.
 - c. A maximum of four XMI PIUs can be placed in a system.
2. XMI PIU Configuration Rules
 - a. Each XMI PIU occupies two of the bottom quadrants: 1 and 2 or 3 and 4. The XMI PIU occupies quadrants 1 and 2 when a VAXBI PIU is installed.
 - b. The XMI bulkhead has 20 dual I/O panels. One is used for the I/O cable from the IOP.
3. XMI Configuration Rules
 - a. Of the 14 slots on the XMI, 12 are available for I/O devices. Two slots are reserved; slot 7, for the T2030- YA, the clock module, and slot 8, for the T2028- AA, the DWLMA module.
 - b. The first option on an XMI must reside either in slot 1 or slot 14 to terminate the bus. If the option is a two- module option, the module with the XMI corner must be in slot 1 or 14.
 - c. If the cabinet has a VAXBI PIU, the T2018 module (XBIA+) must reside in slot 1 of the XMI backplane.

1.2 XMI PIU Kit Contents

The DWLMA XMI PIU option has two variants: one for a system cabinet and the other for an expander cabinet. The only difference between the two kits is the length of the cable that goes from the IOP in the system cabinet to the I/O bulkhead. Figure 1-2 shows the XMI PIU assembly.

Figure 1-2 XMI Card Cage Assembly

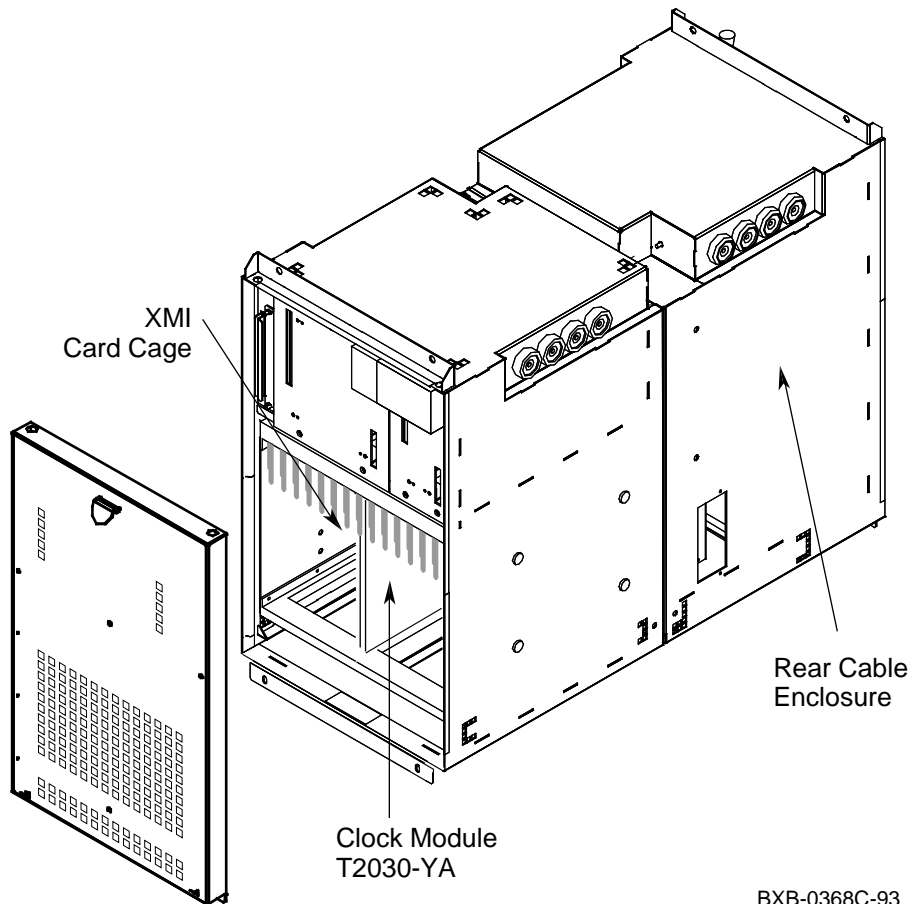

The contents of the two kits follows:

- The XMI PIU card cage assembly consists of two major pieces:
 - The card cage itself with the power regulators which plugs into either cabinet from the front. The clock module is already installed in the card cage.
 - The rear cable enclosure, consisting of the enclosure and the bulkhead panel door that plugs into either cabinet from the back. Figure 1- 2 shows the two pieces. (See Section 2.2 for installation.)
- The DWLMA adapter module is placed in slot 8 of the XMI. (See Section 2.5 for installation.)
- The 4 to 1 cable is placed between the I/O bulkhead and the XMI backplane. (See Section 2.3 for installation.)
- Either the 4.5 foot or 10 foot cable connects the IOP module and the I/O bulkhead. (See Section 2.4 for installation.)

Table 1- 1 DWLMA XMI PIU Kit Contents

Part Number	Quantity	Description
BA651- AA	1	XMI PIU card cage assembly, clock module (T2030- YA), and the DC to DC power regulators
T2028- AA	1	DWLMA module
17- 03061- 01	1	4 to 1 cable with bulkhead
17- 03085- 02	*	4.5 foot hose cable for the system cabinet (DWLMA- AA variant)
17- 03085- 01	*	10 foot hose cable for the expander cabinet (DWLMA- BA variant)
EK- DWLMA- IN	1	This installation guide

* One IOP hose cable is present. The 4.5 foot cable is in the system cabinet kit, and the 10 foot cable is in the expander cabinet kit.

Chapter 2

Installation of the XMI PIU

Five tasks are necessary to install an XMI PIU. They are:

- Preparing the Cabinet
- Installing the Card Cage Assembly
- Installing the 4 to 1 Cable
- Installing the IOP Hose Cable
- Installing the DWLMA

2.1 Preparing the Cabinet

After you determine the XMI PIU quadrant location, you must remove the airflow plates located below the blower and above the quadrants you will be using.

Figure 2- 1 Airflow Plate

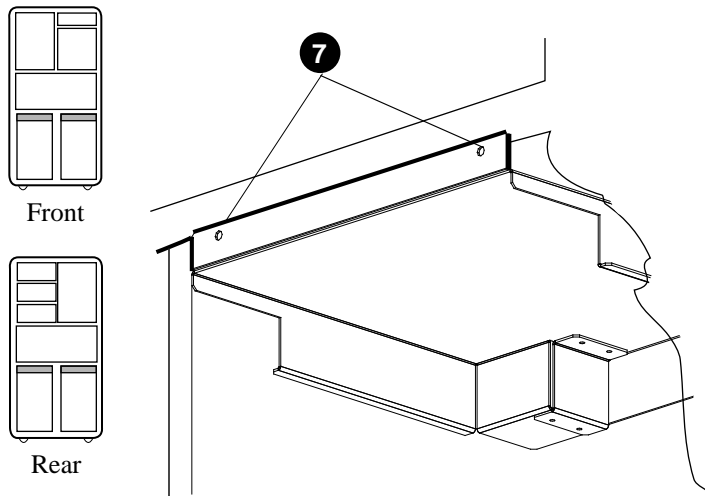

BXB-0412B-93

Take the following steps to prepare the system:

1. Perform an orderly shutdown of the system.
2. Turn the keyswitch to Disable.
3. Determine which quadrants will house the XMI PIU (in the system or expander cabinet). See Section 1.1 for placement rules.
4. Open the front and rear doors of the cabinet. If you are installing the XMI PIU in an expander cabinet, you will need access to the rear of the system cabinet also.
5. Shut the circuit breaker on the AC power box off by pushing down on the breaker. The AC power box is above the blower and to the left in both cabinets.
6. If you are installing the PIU in an expander cabinet, drop the skirts below the rear doors of both cabinets.
7. Remove the two airflow plates from the front and rear of the cabinet (see Figure 2- 1). These slide out of the cabinet and should be labeled and saved. (If the PIU is removed, these plates must be replaced to maintain proper airflow in the cabinet.)
8. The bulkhead door on the rear cable enclosure of the XMI PIU comes hinged on the left. If the XMI PIU is placed in the cabinet on the left when viewed from the rear (quadrants 3 and 4), the door should be hinged on the right. If you need to change the hinges, do that now, following the procedure in Appendix A.

2.2 Installing the Card Cage Assembly

The BA651-AA card cage assembly consists of two parts: the card cage assembly with the clock module and power regulators, and the rear cable enclosure. First install the card cage assembly and then the rear enclosure.

Figure 2-2 Installing the XMI PIU

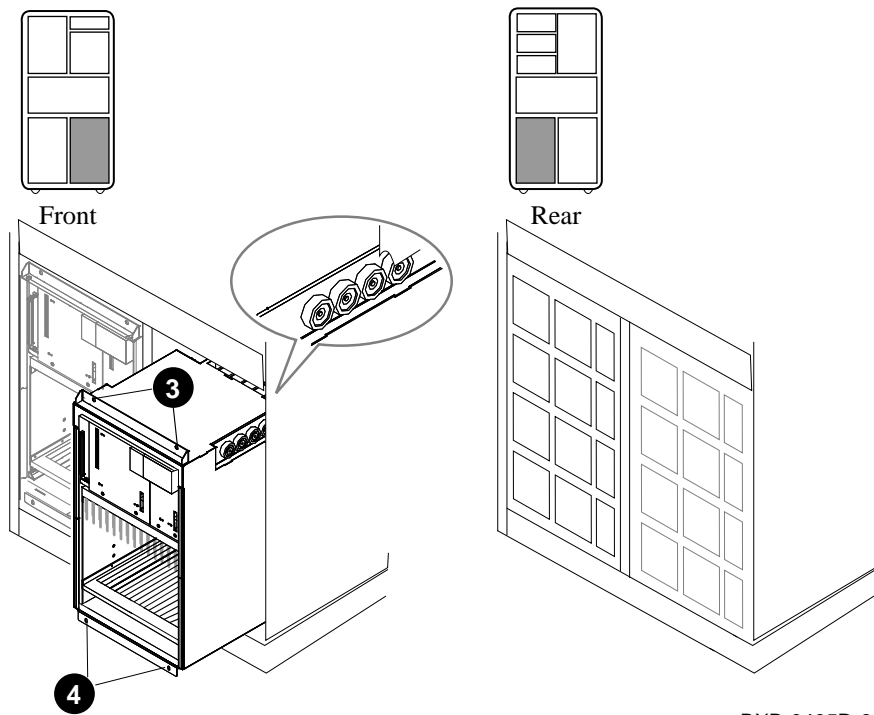

BXB-0405D-93

To install the XMI PIU:

NOTE: Before installing the PIU, inspect the electromagnetic interference (EMI) gaskets; return the option if they are damaged.

1. Ground yourself to the cabinet with the antistatic wrist strap from the Electrical Safety Kit.
2. Place the XMI card cage half into the cabinet by lining up the rollers on the PIU with the slides in the cabinet. Now push the card cage into the cabinet until it seats.
3. Line up and only slightly tighten the two captive screws (slotted) at the top of the PIU, ❸ in Figure 2- 2.
4. Install the two Phillips head screws at the bottom of the card cage securing the PIU to the cabinet, ❹ in Figure 2- 2. Tighten the two captive screws mentioned in step 3 to 27 inch- pounds.
5. Be sure the I/O bulkhead door opens in the correct direction before proceeding to step 6. See Section 2.1, step 8.
6. At the back of the cabinet, install the rear cable enclosure lining up the rollers on the PIU with the slides in the cabinet.
7. Line up and only slightly tighten the two captive screws (slotted) at the top of the enclosure.
8. Install the two Phillips head screws at the bottom of the cable enclosure securing the back of the PIU to the cabinet. Tighten the two captive screws mentioned in step 7 to 27 inch- pounds. Tightening these screws compresses the EMI gaskets between the two halves.

2.3 Installing the 4 to 1 Cable

The 4 to 1 cable, part number 17- 03061- 01, is installed between the XMI backplane and the I/O bulkhead.

Figure 2- 3 Placement of the 4 to 1 Cable

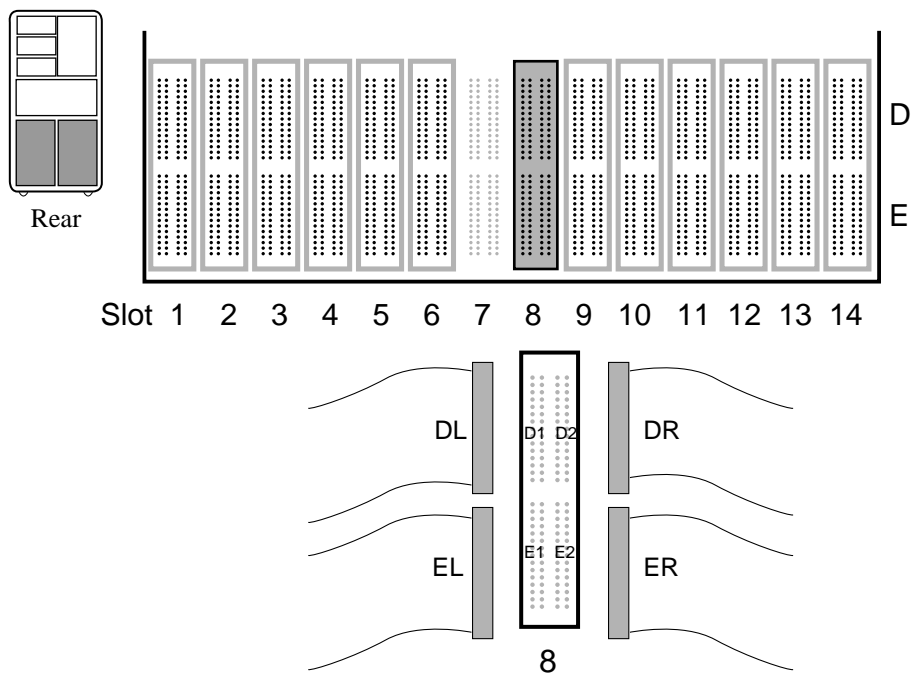

BXB-0444-93

The 4 to 1 cable is labeled for easy, correct installation. The bulkhead end of the cable is easily identified by the bulkhead plate and the receptacle for the IOP cable. The XMI backplane end has four connectors labeled DL, DR, EL, and ER.

To install the cable:

1. Remove the plastic shield from the XMI backplane.
2. Figure 2-4 shows the I/O bulkhead door. If the XMI PIU is installed on the left, the bulkhead plate of the 4 to 1 cable goes in A5; if it is on the right, the bulkhead plate goes in A1. Select and remove the correct panel from the I/O bulkhead door.
3. The IOP connector is offset on the bulkhead plate. When the plate is installed in a system cabinet, the connector is to the left of center. When the plate is installed in an expander cabinet, the connector is right of center. Install the bulkhead end of the 4 to 1 cable in the bulkhead door by passing the cables through the door and secure by using the two screws removed from the plate in step 2.
4. The DWLMA adapter goes in slot 8. Slot 7 is used for the clock module and has no connectors. Slot 8 is to its right on the XMI backplane. See Figure 2-3.
5. Install the cable marked DL into the left receptacle of row D, slot 8.
6. Install the cable marked DR into the right receptacle of row D, slot 8.
7. Install the cable marked EL into the left receptacle of row E, slot 8.
8. Install the cable marked ER into the right receptacle of row E, slot 8.
9. Replace the plastic shield.

Figure 2-4 I/O Bulkhead Panel Designations

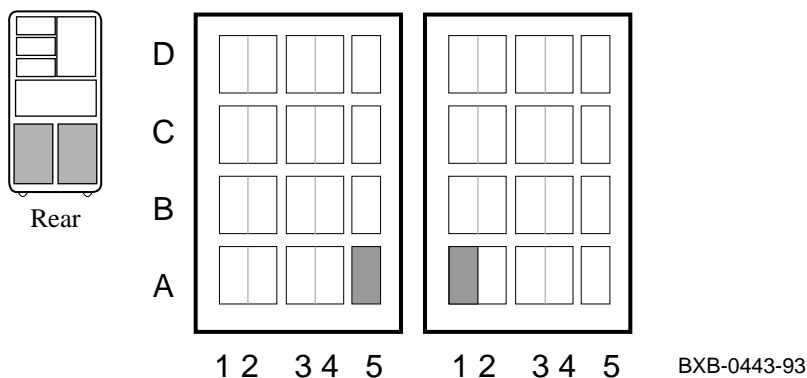

2.4 Installing the IOP Hose Cable

The IOP hose cable, part number 17- 03085- 01 or 17- 03085- 02, connects the IOP in the system cabinet and the I/O bulkhead. The longer hose, the - 01 variation, is used when the PIU is installed in an expander cabinet. Figure 2- 5 shows the IOP cable routing for both system and expander cabinets.

Figure 2- 5 IOP Cable Installation and Routing

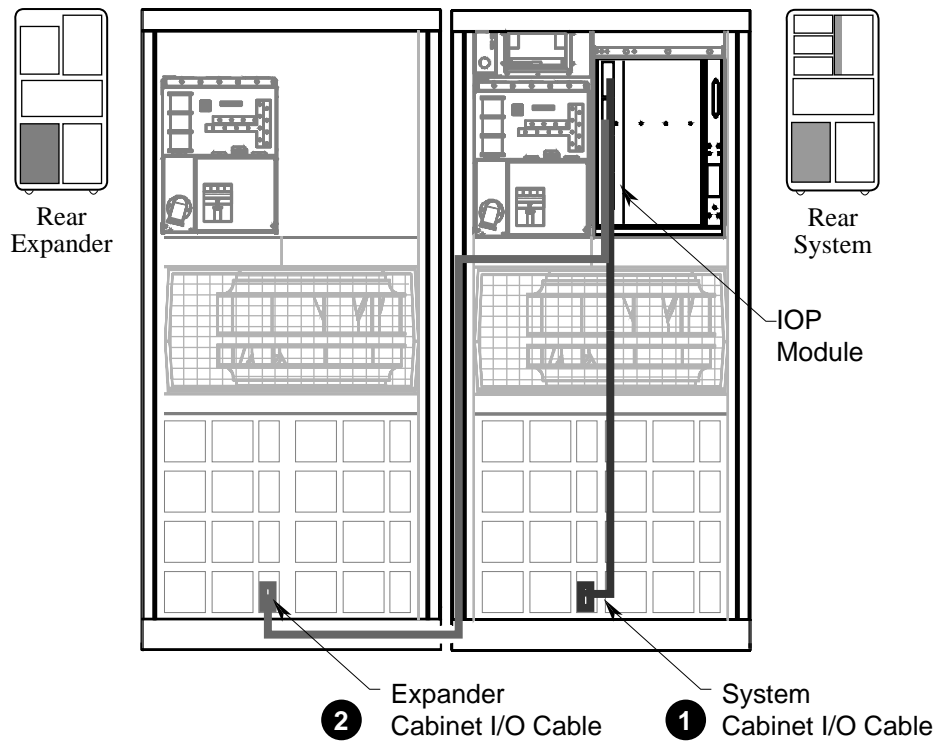

BXB-0437-93

The IOP cable is labeled for easy and correct installation. The IOP end is labeled IOP, and the bulkhead end is labeled PIU.

To install the cable:

1. Plug the IOP end of the cable into one of the IOP module connectors and secure the end of the cable.
2. Route the cable according to Figure 2- 5. ❶ shows the routing for the cable in a system cabinet, and ❷ shows the routing for a cable to an expander cabinet.
3. Plug the PIU end of the cable into the bulkhead connector end of the 4 to 1 cable you just installed and secure the end of the cable.
4. Once the cable has been installed, replace the skirt at the back of the cabinet.

2.5 Installing the DWLMA

The DWLMA is installed in slot 8 of the XMI card cage. The XMI PIU comes with the clock card already installed in slot 7. Slot 8 is to the left of slot 7 when looking into the card cage.

Figure 2-6 Installing the DWLMA

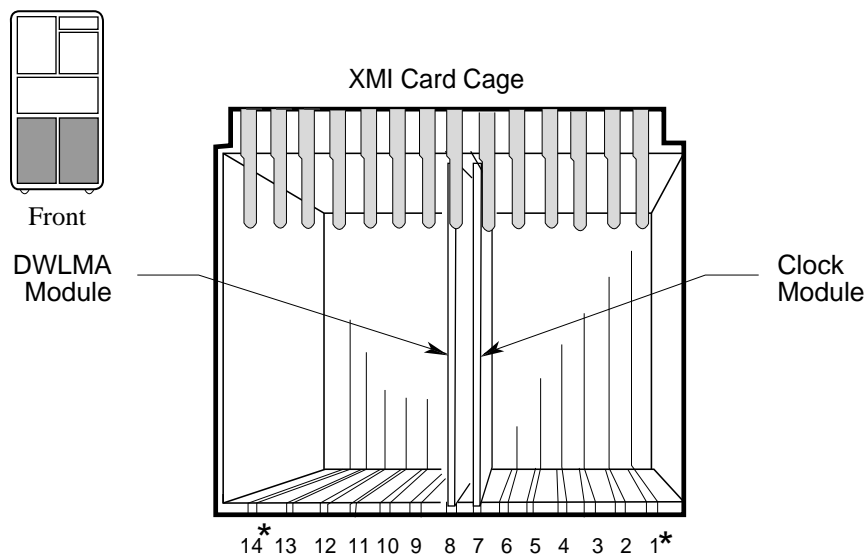

*A module is required in slot 1 or 14 to terminate bus.

BXB-0438-93

To install the DWLMA:

1. At the front of the cabinet, ground yourself using the ESD strap.
2. Install the DWLMA, the T2028- AA module, in slot 8. Slot 8 is the slot to the left of the clock module already installed.

Before installing and cabling all sorts of I/O options, you might want to verify the PIU installation by proceeding to the Verification chapter.

Chapter 3

Verification

This chapter describes the acceptance procedure and troubleshooting guidelines for the XMI PIU. See the *Advanced Troubleshooting* manual for more information. Sections include:

- Restore Power and Check Self- Test Results

3.1 Restore Power and Check Self-Test Results

Install a supported XMI option with an XMI corner in either slot 1 or 14 to terminate the XMI bus. Restore power to the system and check the self-test results to see that the XMI PIU is functioning properly.

Example 3-1 Sample Self-Test Display

```

F  E  D  C  B  A  9  8  7  6  5  4  3  2  1  0  NODE #
      A  M  .  .  .  .  .  .  P  P  TYP
      O  +  .  .  .  .  .  .  +  +  ST1
      .  .  .  .  .  .  .  .  E  B  BPD
      O  +  .  .  .  .  .  .  +  +  ST2
      .  .  .  .  .  .  .  .  E  B  BPD
      +  +  .  .  .  .  .  .  +  +  ST3
      .  .  .  .  .  .  .  .  E  B  BPD

      +  .  .  .  .  .  +  .  .  .  .  +  .  .  C0 XMI + ①
      .  .  .  .  .  .  .  .  .  .  .  .  .  C1 XMI - ②
      .  .  .  .  .  .  .  .  .  .  .  .  .  C2
      .  .  .  .  .  .  .  .  .  .  .  .  .  C3

      .  A0  .  .  .  .  .  .  .  .  ILV
      . 128  .  .  .  .  .  .  .  .  128MB

Firmware Rev = v1.0-1625  SROM Rev = v1.0-0  SYS SN = GA01234567
P00>>>  BXB-0030Q-93

```

To verify that the XMI PIU is functioning properly:

1. Insert a supported XMI option into either slot 1 or 14 to terminate the XMI bus. The module you install must have an XMI corner on it.
2. Power on the system and examine the self- test results to determine whether the XMI PIU passes. Example 3- 1 shows sample self- test results. Two XMIs are shown in the example.

The + at the end of the line marked ❶ shows that the XMI connected to the C0 hose is functioning.

The – at the end of the line marked ❷ shows that the XMI connected to the C1 hose is not functioning.

Lines C0, C1, C2, and C3 correspond to IOP ports (see Figure 3- 1).

In Example 3- 1 the XMI connected to IOP port C1 is failing. If the C line indicates a problem, check all the cabling and retest. If the problem continues, follow the troubleshooting procedures in your system's *Advanced Troubleshooting* manual.

To verify that each slot in the backplane works, do the following:

1. Install a "known good module" in the slot you wish to test.
2. Power on the system.
3. Examine the self- test results to determine whether the slot is working.
4. Repeat steps 1 through 3 for each slot.

If a slot fails, return the option. If the XMI PIU passes verification, continue with the installation of XMI options.

Figure 3- 1 IOP Port Diagram

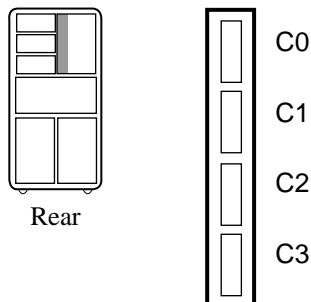

BXB-0623-93

Appendix A

Moving Hinges on the Bulkhead Door

The XMI plug-in unit comes with the rear bulkhead door hinged at the left. The door opens properly when the enclosure is in the rear right quadrant (Q2). When the enclosure is in the rear left quadrant (Q4), the door should be hinged on the right so that the hose is moved as little as possible when the door is opened. This appendix describes how to change the hinges.

A.1 Moving the Hinges of the Bulkhead Door

In addition to moving the hinges from one side of the bulkhead door to the other, the EMI finger stock and the plunger fasteners must be moved.

Figure A-1 Bulkhead Doors on the XMI PIU Rear Cable Enclosure

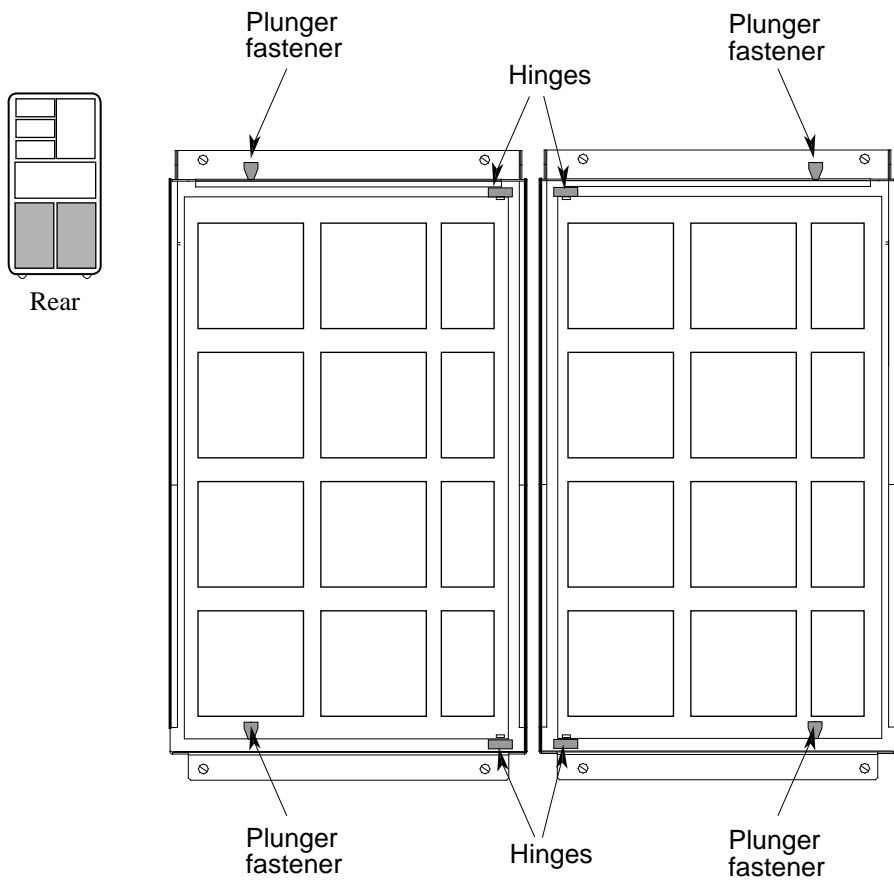

BXB-0446-92

Figure A- 1 shows two bulkhead doors; one hinged left and the other hinged right. Follow these steps when moving the hinges on the doors from one side to the other. The steps assume the door is hinged left.

1. Remove the door by unscrewing the shoulder bolt hinges at the top and bottom. Note that the nylon washers are between the enclosure and the door.
2. Move the plastic spacer on the bottom right flange of the enclosure to the bottom left of the enclosure (where the bottom hinge used to be).
3. Remove the EMI finger stock from the top flange on the enclosure.
4. Using two 3/8 inch wrenches, remove the plunger fastener on the top flange of the enclosure and reinstall it one hole to the left of its original location. Put the plunger in its hold open position to secure the "top" wrench and hold the "nut" under the flange with the other wrench and remove or tighten.
5. Reinstall the EMI finger stock.
6. Remove the EMI finger stock from the bottom of the door.
7. Using two 3/8 inch wrenches remove the plunger fastener on the bottom of the door and reinstall it one hole to the left of its original location. Put the plunger in its hold open position to secure the "top" wrench and hold the "nut" under the flange with the other wrench and remove or tighten.
8. Reinstall the EMI finger stock on the door.
9. Press the door into the enclosure allowing the EMI finger stock to hold it in place.
10. Reinstall the shoulder bolt hinges on the right. Be sure to place the nylon washers between the enclosure and the door.

Index

A

Airflow plate removal, 2- 2

C

Configuration rules, 1- 3

I

Installing

card cage assembly, 2- 4

DWMLA module, 2- 10

IOP cable, 2- 8

rear cable enclosure, 2- 4

4 to 1 cable, 2- 6

I/O port diagram, 3- 4

S

Self- test results, 3- 2

X

XMI configuration rules, 1- 3

XMI PIU

kit contents, 1- 4

placement, 1- 2

XMI termination requirement, 1- 3