

# VAXstation VLC to DEC 3000 Model 300/300L AXP

---

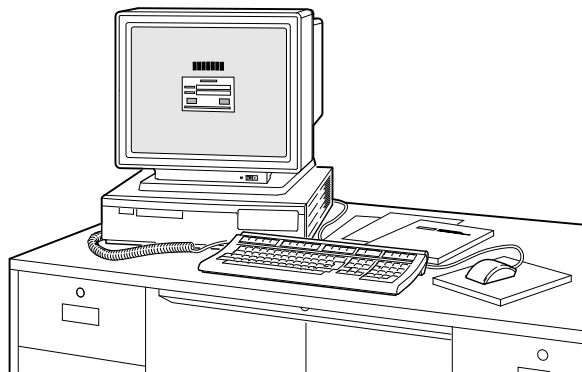

Upgrade Instructions



Order Number: EK-VSAXP-UP. A01

## Options You Can Upgrade

	<b>Can Upgrade</b>	<b>Cannot Upgrade</b>
<b>Expansion Boxes:</b>	SZ03 SZ12 SZ16	
<b>Hard Disks:</b>	RZ23L RZ24L RZ24* RZ25* RZ26* RZ55* RZ56* RZ58*	RZ57
<b>Removable Media:*</b>	TZK10 TZ30 TLZ04 TLZ06 RRD42 RX26	RX23 RX33
<b>Memory Option:</b>	None	

\* Available only in expansion boxes

## Options You Can Upgrade

	<b>Can Upgrade</b>	<b>Cannot Upgrade</b>
<b>Monitors</b>	VRC16-Cx/Hx VRM17-Ax/Hx VR319-Dx** VR320-Dx** VRT16-Hx** VRT19-Hx**	VR262-Ax VR290-Dx VR297-Dx VR299-Dx VRT16-Dx VRT19-Dx VRT13 VR319-Cx VR320-Cx
<b>Input Devices:</b>	VSxxx-AB VSxxx-AA VSxxx-FA VSxxx-JA VSxxx-GA LK401 LK201	
<b>Ethernet Adapter:</b>	DECXM-AA	

\*\* Available only on the Model 300.

## Check the Box Contents

### System Kit:

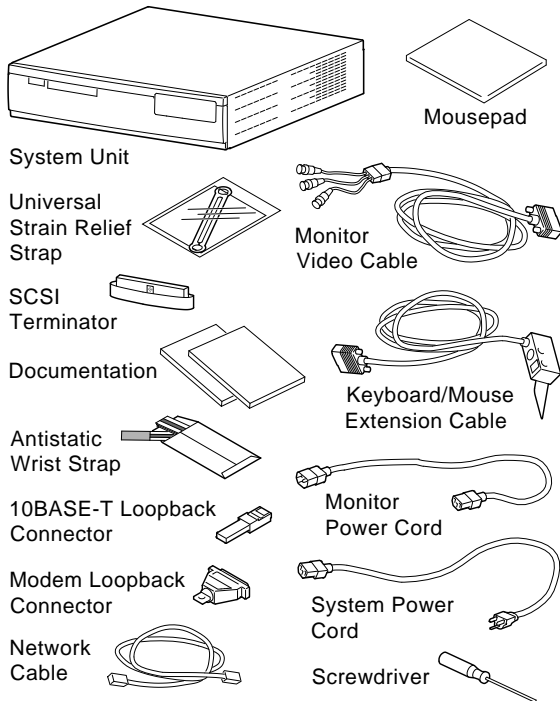

### Accessory Kit:

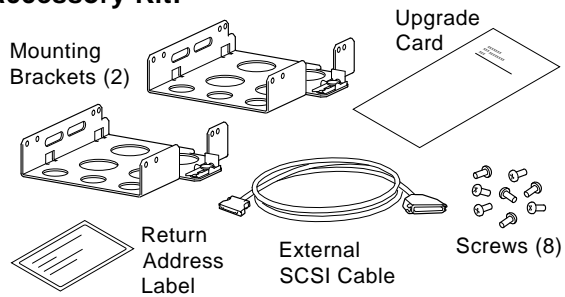

## Check the SCSI ID Settings

If your DEC 3000 system has factory-installed drives, check the SCSI ID settings on the drives you are upgrading.

To find out the SCSI ID settings on your VAXstation drives, enter these commands:

- To shut down your system software:  
\$ SYS\$SYSTEM:SHUTDOWN
- To show the drives and their SCSI ID settings: >> SHOW CONFIG

A screen similar to this will display:

```
>>> SHOW CONFIG
KA48-A V1.3-343-V4.0
08-00-2B-1D-28-6C
8MB
DEVNBR  DEVNAM  INFO
-----
  1      NVR     OK
  2      LCG     OK
                LR - 8 PLN FB - 5.2
  3      DZ      OK
  4      CACHE  OK
  5      MEM     OK
                8MB = S0/1=0MB, S2/3=0MB, S4/5=0MB
  6      FPU     OK
  7      IT      OK
  8      SYS     OK
  9      NI      OK
 10     SCSI    OK
                5-RX26   6-INITR
 11     AUD     OK
>>>
```

SCSI  
ID Numbers

Write your system drive names and SCSI ID settings here:

## Turn Off/Open the VAXstation

1. Turn off the VAXstation system unit by pressing O on the On/Off switch.

**Caution:** After you turn off the system, wait 15 seconds before unplugging the power cord.

2. Unplug all the cables.
3. To open the cover, press firmly on the latches located on the side of the system unit.
  - Push the latches in and up until the cover releases.
  - Pull the cover up and off.

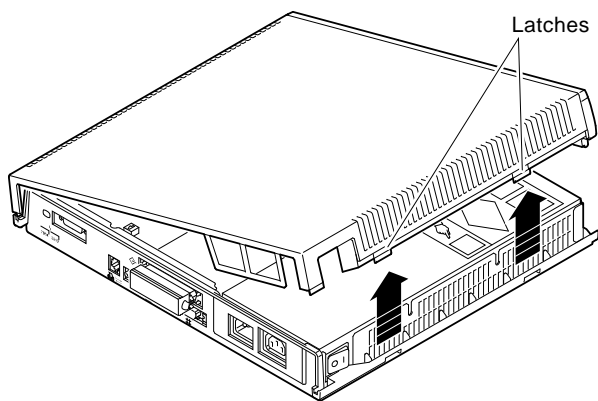

**Caution:** You may damage the equipment if you do not wear an antistatic wrist strap when working inside the system unit.

## Remove/Prepare the Disk Drive

Your VAXstation may have an RZ23L or an RZ24L fixed disk drive installed.

4. Locate the small metal clip attached to the disk mounting bracket.
  - Push in on the metal clip to unlock the bracket, then slide the drive away from the power supply.
  - Remove the drive from the system unit.
  - Disconnect the SCSI and power cable connectors from the drive.
5. Remove the drive bracket and clip by using a Phillips screwdriver to remove the rubber feet.

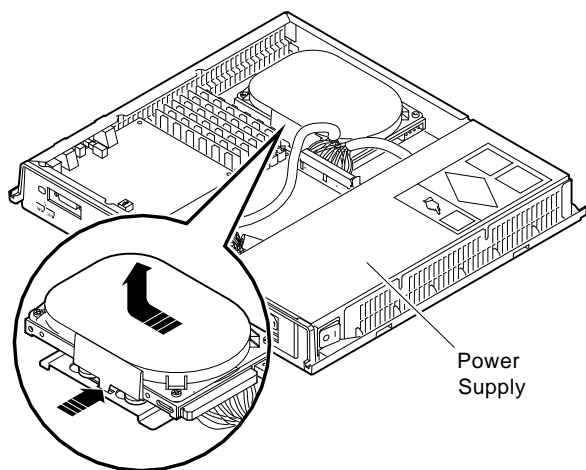

## Set the SCSI ID on the Drives

You need change a SCSI ID setting only if two or more drives have the same setting.

Check the SCSI ID setting for the VAXstation drives, which you noted previously. If you need to change a SCSI ID on a drive that is not covered here, see the *DEC 3000 Model 300/300L AXP System Hardware Reference Guide*.

RZ23L Drive SCSI ID Settings:

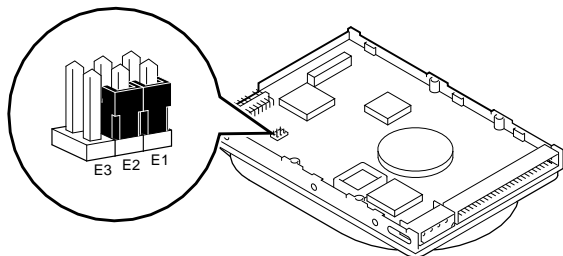

SCSI Settings: 0



1



2



3



4



5



6





## Set the SCSI ID on the Drives

RZ24L Drive SCSI ID Settings:

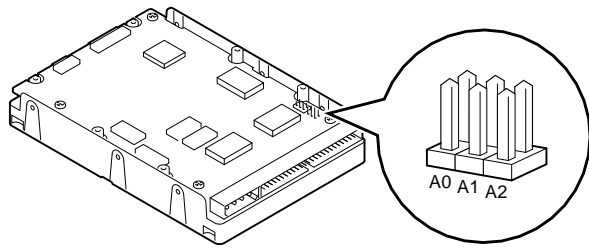

SCSI  
Settings: 0



1



2



3



4



5



6



## Insert a Drive Into a Bracket

If you are upgrading an RZ23L or RZ24L drive from a VLC to a DEC 3000 300/300L, you must put the drive into either of the brackets included in your accessory kit.

- Stand the bracket on its side with the sliding latch up. Place the drive in the bracket with the connectors facing you, as shown below.
- Attach the two screws on each side of the drive bracket.

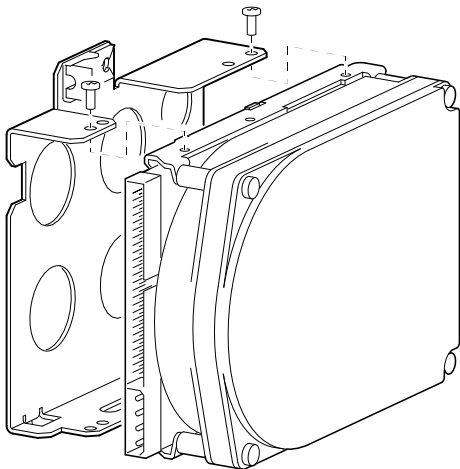

## Complete the Upgrade

6. Follow the instructions in Chapter 2 of the *DEC 3000 Model 300/300L AXP Reference Guide* to install the fixed disk drive.
7. Follow the instructions in the *DEC 3000 Model 300/300L AXP Setting Up Your System* card.
8. Test the installation by turning on your system and entering the `show device` command at the console prompt (`>>>`).

The options you upgraded should appear in the display. If an option does not display, it has not been installed properly.

## Complete the Upgrade

9. Return your VAXstation and any devices that are not upgradable to Digital:
  - Pack the VAXstation and devices securely in the DEC 3000 300/300L packing material.
  - Attach the return- address label that was in your upgrade kit.
  - Contact your Digital service representative to upgrade your hardware service contract.